

**REVISION RECORD FOR THE
STATE OF CALIFORNIA
SUPPLEMENT**

January 31, 2005

2001 Title 24, Part 2, California Building Code

**PLEASE NOTE: The date of this Supplement is for identification purposes only.
See the History Note Appendix for the adoption and effective dates of the provisions.**

It is suggested that the section number as well as the page number be checked when inserting this material and removing the superseded material. In case of doubt, rely on the section numbers rather than the page numbers because the section numbers must run consecutively.

It is further suggested that the superseded material be retained with this revision record sheet so that the prior wording of any section can be easily ascertained.

Please keep the removed pages with this revision page for future reference.

NOTE

Due to the fact that the application date for a building permit establishes the California Building Standards code provisions that are effective at the local level, which apply to the plans, specifications, and construction for that permit, it is strongly recommended that the removed pages be retained for historical reference.

VOLUME 1

Remove Existing Pages

1-xvi.3 and 1-xvi.4
1-xvi.27 and 1-xvi.28

1-449 and 1-450

Insert Blue Pages

1-xvi.3 and 1-xvi.4
1-xvi.27 and 1-xvi.28
1-294.25 through 1-294.84
1-449 and 1-450

MATRIX ADOPTION TABLES—VOLUME 1

CHAPTER 1—ADMINISTRATION

ENFORCING AUTHORITY		LOCAL BUILDING OFFICIAL					LOCAL FIRE OFFICIAL	LOCAL HEALTH OFFICIAL	STATE AGENCY														
		CEC	CA	HCD		DSA AC			SFM	DHS	DWR	AGR	BOC	BSC	DSA SS	OSHPD				DOSH*	SL	SLC	
1/AC	1			2	1		2	3								4							
Adopt entire UBC chapter without amendments																							
Adopt entire UBC chapter as amended (amended sections listed below)							X							X	X	X	X						
Adopt only those sections that are listed below			X	X	X	X		X	X		X	X	X	X								X	
101.1	CA		X		X	X	X	X	X		X	X	X	X	X	X	X					X	
101.2	UBC		X	X	X	X		X	X		X	X	X	X	X	X	X					X	
101.2	CA						X																
101.2.1.1.4	CA				X																		
101.3.1	CA		X		X	X	X	X	X		X	X	X	X	X	X	X					X	
101.4 - 101.4.1	CA		X		X	X	X	X	X		X	X	X	X	X	X	X					X	
101.5	CA		X		X	X	X	X	X		X	X	X	X	X	X	X					X	
101.6	CA		X		X	X	X	X	X		X	X	X	X	X	X	X					X	
101.7	CA		X		X	X	X	X	X		X	X	X	X	X	X	X					X	
101.8	CA		X		X	X	X	X	X		X	X	X	X	X	X	X					X	
101.9	CA		X		X	X	X	X	X		X	X	X	X	X	X	X					X	
101.9.1	CA				X	X	X																
101.9.2	CA				X	X	X																
101.11	CA				X	X		X					X										
101.12	CA				X	X		X					X										
101.13	CA				X	X		X															
101.14	CA				X	X		X															
101.15	CA				◆	◆		X															
101.16	CA		X		X	X	X	X	X		X	X	X	X	X	X	X					X	
101.17	CA		X	X	X	X	X	X	X		X	X	X	X	X	X	X					X	
101.17.9	CA				X																		
101.17.9.1	CA			X																			
101.17.10	CA					X																	
101.17.11	CA						X																
101.17.12	CA												X										
101.17.14	CA							X															
102.1	CA							X															
102.2	CA				X																		
102.2.1	CA					X																	
102.2.2	CA				X																		
103.1	CA				◆	◆		X															
103.2	CA				X																		
103.2.1	CA					X																	
103.2.2	CA				X																		
104	CA							X															
104.2.1.1	CA				X																		
104.2.1.1.1	CA				X																		
104.2.1.1.2	CA					X																	

(Continued)

CHAPTER 1—ADMINISTRATION—(Continued)

ENFORCING AUTHORITY		LOCAL BUILDING OFFICIAL					LOCAL FIRE OFFICIAL	LOCAL HEALTH OFFICIAL	STATE AGENCY													
ADOPTING AGENCY	CEC	CA	HCD			DSA AC	SFM	DHS	DWR	AGR	BOC	BSC	DSA SS	OSHPD				DOSH*	SL	SLC		
			1/AC	1	2									1	2	3	4					
104.2.1.1.3	CA			X																		
104.2.3.1	CA			X	X																	
104.2.8.1	CA			X																		
104.2.8.1.1	CA				X																	
104.2.8.1.2	CA			X																		
104.2.8.2	CA			X																		
105.1.1	CA			◆	◆		X															
106.2	CA						X															
106.3.3.1 - 106.3.3.4	CA			◆	◆		X															
106.4.1	CA						X															
106.4.2.1	CA			X																		
107.1.1	CA			X																		
107.1.2	CA			X																		
107.6.1	CA			◆	◆		X															
108 - 108.5.1	UBC						X															
108.1.1	CA			X																		
108.5.1	CA			X																		
108.5.2	CA			X																		
108.5.3	CA			X																		
108.5.4 - 108.8	UBC						X															
108.5.4	CA			X																		
108.5.5	CA			X																		
108.5.6	CA			X																		
108.6	UBC			X																		
109	UBC			◆	◆		X															

*DOSH has not adopted the 1997 edition of the *Uniform Building Code*. The 1995 edition of the *California Building Code* remains effective. The ◆ designation indicates that the State Fire Marshal's adoption of this chapter or individual sections is applicable to structures subject to HCD 1 and/or HCD 2.

CHAPTER 31C—RADIATION

ENFORCING AUTHORITY	LOCAL BUILDING OFFICIAL						LOCAL FIRE OFFICIAL	LOCAL HEALTH OFFICIAL	STATE AGENCY										
ADOPTING AGENCY	CEC	CA	HCD			DSA AC	SFM	DHS	DWR	AGR	BOC	BSC	DSA SS	OSHPD				DOSH*	SL
			1/AC	1	2									1	2	3	4		
Adopt entire California chapter								X											

*DOSH has not adopted the 1997 edition of the *Uniform Building Code*. The 1995 edition of the *California Building Code* remains effective. The ♦ designation indicates that the State Fire Marshal’s adoption of this chapter or individual sections is applicable to structures subject to HCD 1 and/or HCD 2.

CHAPTER 31D—FOOD ESTABLISHMENTS

ENFORCING AUTHORITY	LOCAL BUILDING OFFICIAL						LOCAL FIRE OFFICIAL	LOCAL HEALTH OFFICIAL	STATE AGENCY										
ADOPTING AGENCY	CEC	CA	HCD			DSA AC	SFM	DHS	DWR	AGR	BOC	BSC	DSA SS	OSHPD				DOSH*	SL
			1/AC	1	2									1	2	3	4		
Adopt entire California chapter								X											

*DOSH has not adopted the 1997 edition of the *Uniform Building Code*. The 1995 edition of the *California Building Code* remains effective. The ♦ designation indicates that the State Fire Marshal’s adoption of this chapter or individual sections is applicable to structures subject to HCD 1 and/or HCD 2.

CHAPTER 31E—TENTS AND MEMBRANE STRUCTURES

ENFORCING AUTHORITY	LOCAL BUILDING OFFICIAL						LOCAL FIRE OFFICIAL	LOCAL HEALTH OFFICIAL	STATE AGENCY										
ADOPTING AGENCY	CEC	CA	HCD			DSA AC	SFM	DHS	DWR	AGR	BOC	BSC	DSA SS	OSHPD				DOSH*	SL
			1/AC	1	2									1	2	3	4		
Adopt entire California chapter							X												

*DOSH has not adopted the 1997 edition of the *Uniform Building Code*. The 1995 edition of the *California Building Code* remains effective. The ♦ designation indicates that the State Fire Marshal’s adoption of this chapter or individual sections is applicable to structures subject to HCD 1 and/or HCD 2.

CHAPTER 31F—MARINE OIL TERMINALS

ENFORCING AUTHORITY	LOCAL BUILDING OFFICIAL						LOCAL FIRE OFFICIAL	LOCAL HEALTH OFFICIAL	STATE AGENCY											
ADOPTING AGENCY	CEC	CA	HCD			DSA AC	SFM	DHS	DWR	AGR	BOC	BSC	DSA SS	OSHPD				DOSH*	SL	SLC
			1/AC	1	2									1	2	3	4			
Adopt entire California chapter																				X

*DOSH has not adopted the 1997 edition of the *Uniform Building Code*. The 1995 edition of the *California Building Code* remains effective.

CHAPTER 32—CONSTRUCTION IN THE PUBLIC RIGHT OF WAY

ENFORCING AUTHORITY	LOCAL BUILDING OFFICIAL						LOCAL FIRE OFFICIAL	LOCAL HEALTH OFFICIAL	STATE AGENCY										
ADOPTING AGENCY	CEC	CA	HCD			DSA AC	SFM	DHS	DWR	AGR	BOC	BSC	DSA SS	OSHPD				DOSH*	SL
			1/AC	1	2									1	2	3	4		
Adopt entire UBC chapter without amendments				X	X		X					X	X	X	X				
Adopt entire UBC chapter as amended (amended sections listed below)																			
Adopt only those sections that are listed below																			

*DOSH has not adopted the 1997 edition of the *Uniform Building Code*. The 1995 edition of the *California Building Code* remains effective. The ♦ designation indicates that the State Fire Marshal’s adoption of this chapter or individual sections is applicable to structures subject to HCD 1 and/or HCD 2.

CHAPTER 33—SITE WORK, DEMOLITION AND CONSTRUCTION

ENFORCING AUTHORITY		LOCAL BUILDING OFFICIAL					LOCAL FIRE OFFICIAL	LOCAL HEALTH OFFICIAL	STATE AGENCY											
ADOPTING AGENCY	CEC	CA	HCD			DSA AC	SFM	DHS	DWR	AGR	BOC	BSC	DSS	OSHPD				DOSH*	SL	
			1/AC	1	2									1	2	3	4			
Adopt entire UBC chapter without amendments				X	X							X			X	X				
Adopt entire UBC chapter as amended (amended sections listed below)												X	X				X			
Adopt only those sections that are listed below																				
3301.1	CA											X	X							
3301.2a	CA											X	X				X			
3301.3	CA											X	X				X			

*DOSH has not adopted the 1997 edition of the *Uniform Building Code*. The 1995 edition of the *California Building Code* remains effective.
 The ♦ designation indicates that the State Fire Marshal's adoption of this chapter or individual sections is applicable to structures subject to HCD 1 and/or HCD 2.

CHAPTER 34—EXISTING STRUCTURES

ENFORCING AUTHORITY		LOCAL BUILDING OFFICIAL					LOCAL FIRE OFFICIAL	LOCAL HEALTH OFFICIAL	STATE AGENCY											
ADOPTING AGENCY	CEC	CA	HCD			DSA AC	SFM	DHS	DWR	AGR	BOC	BSC	DSS	OSHPD				DOSH*	SL	
			1/AC	1	2									1	2	3	4			
Adopt entire UBC chapter without amendments							X					X		X			X			
Adopt entire UBC chapter as amended (amended sections listed below)																				
Adopt only those sections that are listed below			X	X	X	X														
3401 Note	CA					X														
3401.1	CA		X	X																
3401.2	CA				X															
3405	UBC			X	X															
3405.1	UBC			X																
Division II	CA					X														

*DOSH has not adopted the 1997 edition of the *Uniform Building Code*. The 1995 edition of the *California Building Code* remains effective.
 The ♦ designation indicates that the State Fire Marshal's adoption of this chapter or individual sections is applicable to structures subject to HCD 1 and/or HCD 2.

Chapter 31F [For SLC]
MARINE OIL TERMINALS

Division I

SECTION 3101F [SLC] — INTRODUCTION

3101F.1 General. The Lempert-Keene-Seastrand oil spill prevention and response act of 1990 (act), as amended, authorized the California State Lands Commission (SLC) to regulate marine oil terminals (MOTs) in order to protect public health, safety, and the environment. The authority for this regulation is contained in Sections 8755 and 8756 of the California Public Resources Code. This act defines “oil” as any kind of petroleum, liquid hydrocarbons, or petroleum products or any fraction or residues thereof, including but not limited to, crude oil, bunker fuel, gasoline, diesel fuel, aviation fuel, oil sludge, oil refuse, oil mixed with waste, and liquid distillates from unprocessed natural gas. The provisions of this Chapter regulate marine oil terminals as defined under this act.

3101F.2 Purpose. The purpose of this Code is to establish minimum engineering, inspection and maintenance criteria for MOTs in order to prevent oil spills and to protect public health, safety and the environment. This Code does not, in general, address operational requirements. Relevant provisions from existing codes, industry standards, recommended practices, regulations and guidelines have been incorporated directly or through reference, as part of this Code.

Where there are differing requirements between this Code and/or references cited herein, the choice of application shall be subject to approval of the Marine Facilities Division (Division) of the SLC.

In special circumstances where certain requirements of these standards cannot be met, alternatives that provide an equal or better protection of the public health, safety and the environment shall be subject to Division approval.

3101F.3 Applicability. The provisions of this Chapter are applicable to the evaluation of existing MOTs and design of new MOTs in California. Each provision is classified as New (N), Existing (E), or Both (N/E) and shall be applied accordingly. If no classification is indicated, the classification shall be considered to be (N/E).

Existing (E) requirements apply to MOTs that are in operation on the date this Code is adopted. For these MOTs, equivalent or in-kind replacement of existing equipment, short pipeline sections, or minor modification of existing components shall also be subject to the existing (E) requirements.

New (N) requirements apply to:

1. A MOT or berthing system (subsection 3102F.1.3) that commences or recommences operation with a new or modified operations manual after adoption of this Code.
2. Addition of new structural components or systems at an existing MOT that are structurally independent of existing components or systems.
3. Addition of new (non-replacement) equipment, piping, pipelines, components or systems to an existing MOT.
4. Major repairs or substantially modified in-place systems.
5. Any associated major installations or modifications.

3101F.4 Overview. This Code ensures that a MOT can be safely operated within its inherent structural and equipment-related constraints.

Section 3102F defines minimum requirements for audit, inspection and evaluation of the structural, electrical and mechanical systems on a prescribed periodic basis, or following a significant damage-causing event.

Section 3103F, 3104F and 3107F provide criteria for structural loading, deformation and performance-based evaluation considering earthquake, wind, wave, current, seiche and tsunami effects.

Section 3105F provides requirements for the safe mooring and berthing of tank vessels and barges.

Section 3106F describes requirements for geotechnical hazards and foundation analyses, including consideration of slope stability and soil failure.

Section 3108F provides requirements for fire prevention, detection and suppression including appropriate water and foam volumes.

Sections 3109F through 31011F provide requirements for piping, mechanical and electrical equipment.

English units are prescribed herein; however, many of the units in the references are in System International (SI).

3101F.5 Risk Reduction Strategies. Risk reduction strategies, such as pipeline segmentation devices, system flexibility and spill containment devices may be used to reduce the size of a potential oil spill. Such strategies may reduce the MOT risk classification as determined from Table 31F-4-1.

3101F.6 Review Requirements.

3101F.6.1 Quality Assurance. All audits, inspections, engineering analyses or design shall be reviewed by a professional having similar or higher qualifications as the person who performed the work, to ensure quality assurance. This review may be performed in-house.

Peer review is required for nonlinear dynamic structural analyses and alternative lateral force procedures not prescribed herein. The peer review may be from an independent internal or external source. The peer reviewer shall be a California registered civil or structural engineer.

3101F.6.2 Division Review. The following will be subject to review and approval by the Division or its designated representative(s) for compliance with this Code:

1. Any audit, inspection, analysis or evaluation of existing MOTs.
2. Any significant change, modification or re-design of a structural, mooring, fire, piping/pipelines, mechanical or electrical system at an existing MOT, prior to use or reuse.
3. Engineering analysis and design for any new MOT prior to construction.
4. Construction inspection team and the construction inspection report(s).

Authority: Sections 8755 and 8757, Public Resources Code.
Reference: Sections 8750, 8751, 8755 and 8757, Public Resources Code.

Division 2

SECTION 3102F — AUDIT AND INSPECTION

3102F.1 General.

3102F.1.1 Purpose. Section 3102F defines minimum requirements for audit, inspection, and evaluation of the structural, mechanical and electrical components and systems.

3102F.1.2 Audit and Inspections Types. The audit and inspections described in this Chapter (31F) and 2 CCR 2320 (a) and (b) [2.1] are:

1. Annual Inspection
2. Audit
3. Post-Event Inspection

Each has a distinct purpose and is conducted either at a defined interval (see Tables 31F-2-1 and 31F-2-2), as a result of a potentially damaging event or a significant change in operations. In the time between audits and inspections, operators are expected to conduct periodic walk-down examinations of the MOT to detect potentially unsafe conditions.

**TABLE 31F-2-1
INITIAL AUDIT REPORT SUBMISSION DEADLINE
FOR EXISTING BERTHING SYSTEMS**

RISK CLASSIFICATION ¹	SUBMISSION DEADLINE ²
High	30 Months
Medium	48 Months
Low	60 Months

¹As defined in Tables 31F-4-1 and 31F-5-1.

²From the effective date of this Chapter (31F).

3102F.1.3 Berthing Systems. For the purpose of assigning structural ratings and documenting the condition of mechanical and electrical systems, an MOT shall be divided into independent

“berthing systems.” A berthing system consists of the wharf and supporting structure, mechanical and electrical components that serve the berth and the entire pipeline from the loading arm or manifold to the last valve before the pipeline enters a tank storage area.

For example, a MOT consisting of wharves with three berths adjacent to the shoreline could contain three independent “berthing systems” if the piping does not route through adjacent berths. Therefore, a significant defect that would restrict the operation of one berth would have no impact on the other two berths. Conversely, if a T-head Pier, with multiple berths sharing a trestle that supports all piping to the shoreline, had a significant deficiency on the common trestle, the operation of all berths could be adversely impacted. This configuration is classified as a single berthing system.

The physical boundaries of a berthing system may exclude unused sections of a structure. Excluded sections must be physically isolated from the berthing system. Expansion joints may provide this isolation.

3102F.1.4 Records. All MOTs shall have records reflecting current, as-built conditions for all berthing systems. Records shall include, but not be limited to modifications and/or replacement of structural components, electrical or mechanical equipment or relevant operational changes, new construction including design drawings, calculations, engineering analyses, soil borings, equipment manuals, specifications, shop drawings, technical and maintenance manuals and documents.

Chronological records and reports of Annual Inspections, Audits and Post-Event Inspections and documentation of equipment or structural changes shall be maintained.

Records shall be indexed and be readily accessible to the Division (see 2 CCR Section 2320 (c) (2)) [2.1].

**TABLE 31F-2-2
MAXIMUM INTERVAL BETWEEN UNDERWATER AUDIT INSPECTIONS (YEARS)¹**

CONDITION RATING FROM PREVIOUS INSPECTION	CONSTRUCTION MATERIAL				CHANNEL BOTTOM OR MUD LINE—SCOUR ⁴	
	Unwrapped Timber or Unprotected Steel (no coating or cathodic protection) ⁴		Concrete, Wrapped Timber, Protected Steel or Composite Materials (FRP, plastic, etc.) ⁴		Benign ² Environment	Aggressive ³ Environment
	Benign ² Environment	Aggressive ³ Environment	Benign ² Environment	Aggressive ³ Environment		
6 (Good)	6	4	6	5	6	5
5 (Satisfactory)	6	4	6	5	6	5
4 (Fair)	5	3	5	4	6	5
3 (Poor)	4	3	5	4	6	5
2 (Serious)	2	1	2	2	2	2
1 (Critical)	N/A ⁵	N/A ⁵	N/A ⁵	N/A ⁵	N/A ⁵	N/A ⁵

¹The maximum interval between Underwater Audit Inspections shall be reduced as appropriate based on the extent of deterioration observed on a structure, the rate of further anticipated deterioration or other factors.

²Benign environments include fresh water and maximum current velocities less than 1.5 knots for the majority of the days in a calendar year.

³Aggressive environments include brackish or salt water, polluted water, or waters with current velocities greater than 1.5 knots for the majority of the days in the calendar year.

⁴For most structures, two maximum intervals will be shown in this table, one for the assessment of construction material (timber, concrete, steel, etc.) and one for scour (last 2 columns). The shorter interval of the two should dictate the maximum interval used.

⁵MOTs rated “Critical” will not be operational; and Emergency Action shall be required in accordance with Table 31F-2-7.

3102F.1.5 Baseline Inspection. If “as-built” or subsequent modification drawings are not available, incomplete, or inaccurate, the Audit must include a Baseline Inspection to gather data in sufficient detail to adequately evaluate the MOT.

The level of detail required shall be such that structural member sizes, connection and reinforcing details are documented, if required in the structural analysis. In addition, the strength and/or ductility characteristics of construction materials shall be determined, as appropriate. Nondestructive testing, partially destructive testing and/or laboratory testing methods may be used.

All fire, piping, mechanical and electrical systems shall be documented as to location, capacity, operating limits and physical conditions.

3102F.2 Annual Inspection. The Annual Inspection required by 2 CCR 2320 (a)(1) [2.1], may include an engineering examination of the topside and underside areas of the dock, including the splash zone. The Division shall perform the inspection, with cooperation from the owner/operator. Observations will be recorded and a report of violations and deficiencies shall be provided to the operator.

Subject to operating procedures, a boat shall be provided to facilitate the inspection of the dock undersides and piles down to the splash zone. If a boat is not available or the under dock inspection cannot be performed by the Division during the Annual Inspection, the MOT operator shall carry out or cause to be carried out, such an inspection. The operator will then provide the Division with a report detailing the examination results including photographs, videos and sketches as necessary to accurately depict the state of the underside of the dock.

3102F.3 Audit.

3102F.3.1 Objective. The objective of the Audit is to review structural, mechanical and electrical systems on a prescribed periodic basis to verify that each berthing system is fit for its specific defined purpose. The Audit includes both above water and underwater inspections, as well as engineering analyses.

3102F.3.2 Overview. The Initial Audit shall include above water and underwater structural inspections, mooring, berthing and structural evaluations, and electrical/mechanical systems evaluation. The audit is performed by a multidisciplinary team of engineers, qualified inspectors and may include Division representatives.

The above water inspection involves an examination of all structural, mechanical and electrical components above the waterline. Structural defects and their severity shall be documented, but the exact size and location of each deficiency is typically not required.

Representative underwater sampling may be acceptable with Division approval, for cases of limited visibility, heavy marine growth, restricted inspection times because of environmental factors (currents, water temperatures, etc.) or a very large number of piles [2.2].

A global Condition Assessment Rating (CAR) shall be assigned to above and underwater structural systems (Table 31F-2-5).

Remedial Action Priorities (RAP) shall be assigned for component deficiencies (Table 31F-2-6). Recommendations for remediation and/or upgrading shall be prescribed as necessary.

An Audit is not considered complete until the Audit Report is received by the Division.

3102F.3.3 Schedule.

3102F.3.3.1 Initial Audit. Table 31F-2-1 provides the deadlines for the submission of the Initial Audit report. The MOT classification in Table 31F-2-1 is determined from the higher assigned risk classification obtained from Table 31F-4-1.

For a new MOT berthing system, the Initial Audit shall be performed within three years of commencement of operations.

3102F.3.3.2 Subsequent Audits. An above water Audit of structural, mechanical and electrical systems shall be completed at a maximum interval of 3 years. This interval may be reduced, based on the recommendation of the Audit Team Leader, and with the approval of the Division, depending on the extent and rate of deterioration or other factors.

The maximum interval for underwater Audits is dependent upon the condition of the facility, the construction material type and/or the environment at the mudline, as shown in Table 31F-2-2.

If there are no changes in the defined purpose (see subsection 3102F.3.6.1) of the berthing system, then analyses from previous Audits may be referenced. However, if there is a significant change in a berthing system, or when deterioration or damage must be considered, a new analysis may be required.

The Division may require an Audit to justify changes in the use of a berthing system. An example of such change would be in the berthing and mooring configuration of larger or smaller vessels relative to dolphin and fender spacing, and potential resultant modification to operational environmental limitations (e.g. wind speed).

Subsequent audits of the above water and underwater structures and mechanical and electrical systems may or may not be performed concurrently, depending upon the required inspection intervals based on the prior audit report.

3102F.3.4 Audit Team.

3102F.3.4.1 Project Manager. The Audit shall be conducted by a multidisciplinary team under the direction of a Project Manager representing the MOT. The Project Manager shall have specific knowledge of the MOT and may serve other roles on the Audit Team.

3102F.3.4.2 Audit Team Leader. The Audit Team Leader shall lead the on-site audit team and shall be responsible for directing field activities, including the inspection of all structural, mechanical and electrical systems. The Team Leader shall be a California registered civil or structural engineer and may serve other roles on the audit team.

3102F.3.4.3 Structural Inspection Team. The structural inspection shall be conducted under the direction of a registered civil or structural engineer.

All members of the structural inspection team shall be graduates of a 4-year civil/structural engineering, or closely related (ocean/coastal) engineering curriculum, and shall have been certified as an Engineer-in-Training; or shall be technicians who have completed a course of study in structural inspections. The minimum acceptable course in structural inspections shall include 80 hours of instruction specifically related to structural inspection, followed by successful completion of a comprehensive examination. An example of an acceptable course is the U.S. Department of Transportation’s “Safety Inspection of In-Service Bridges”. Certification as a Level IV Bridge Inspector by the National Institute of Certification in Engineering Technologies (NICET) shall also be acceptable [2.3].

For underwater inspections, the registered civil or structural engineer directing the underwater structural inspection shall also

be a commercially trained diver or equivalent and shall actively participate in the inspection, by personally conducting a minimum of 25 percent of the underwater examination [2.3].

Each underwater team member shall also be a commercially trained diver, or equivalent. Divers performing manual tasks such as cleaning or supporting the diving operation, but not conducting or reporting on inspections, may have lesser technical qualifications [2.3].

3102F.3.4.4 Seismic Structural Analyst. A California registered civil or structural engineer shall perform the seismic structural evaluation required for the Audit.

3102F.3.4.5 Electrical Inspection Team. A registered electrical engineer shall direct the on-site team performing the inspection and evaluation of electrical components and systems.

3102F.3.4.6 Mechanical Inspection Team. A registered engineer shall direct the on-site team performing the inspection of pipeline, mechanical and fire systems.

3102F.3.4.7 Divisional Representation. The Division representative(s) may participate in any Audit as observer(s) and may provide guidance.

3102F.3.5 Scope of Inspection.

3102F.3.5.1 Above Water Structural Inspection. The above water inspection shall include all accessible components above +3 ft MLLW. Accessible components shall be defined as those components above and below deck that are reachable without the need for excavation or extensive removal of materials that may impair visual inspection. The above water inspection shall include but not be limited to the following:

1. Piles
2. Pile caps
3. Beams
4. Deck soffit
5. Bracing
6. Retaining walls and bulkheads
7. Connections
8. Seawalls
9. Slope protection
10. Deck topsides and curbing
11. Expansion joints
12. Fender system components
13. Dolphins and deadmen
14. Mooring points and hardware
15. Navigation aids
16. Platforms, ladders, stairs, handrails and gangways
17. Backfill (sinkholes/differential settlement)

3102F.3.5.2 Underwater Structural Inspection. The underwater inspection shall include all accessible components from +3 ft MLLW to the mudline, including the slope and slope protection, in areas immediately surrounding the MOT. The water depth at the berth(s) shall be evaluated, verifying the maximum or loaded draft specified in the MOT's Operations Manual (2 CCR 2385 (d)) [2.1].

The underwater structural inspection shall include the Level I, II and III inspection efforts, as shown in Tables 31F-2-3 and

31F-2-4. The underwater inspection levels of effort are described below, per [2.3]:

Level I—Includes a close visual examination, or a tactile examination using large sweeping motions of the hands where visibility is limited. Although the Level I effort is often referred to as a "Swim-By" inspection, it must be detailed enough to detect obvious major damage or deterioration due to overstress or other severe deterioration. It should confirm the continuity of the full length of all members and detect undermining or exposure of normally buried elements. A Level I effort may also include limited probing of the substructure and adjacent channel bottom.

Level II—A detailed inspection which requires marine growth removal from a representative sampling of components within the structure. For piles, a 12-inch high band should be cleaned at designated locations, generally near the low waterline, at the mudline, and midway between the low waterline and the mudline. On a rectangular pile, the marine growth removal should include at least three sides; on an octagon pile, at least six sides; on a round pile, at least three-fourths of the perimeter. On large diameter piles, 3 ft or greater, marine growth removal should be effected on 1 ft by 1 ft areas at four locations approximately equally spaced around the perimeter, at each elevation. On large solid faced elements such as retaining structures, marine growth removal should be effected on 1 ft by 1 ft areas at the three specified elevations. The inspection should also focus on typical areas of weakness, such as attachment points and welds. The Level II effort is intended to detect and identify damaged and deteriorated areas that may be hidden by surface biofouling. The thoroughness of marine growth removal should be governed by what is necessary to discern the condition of the underlying structural material. Removal of all biofouling staining is generally not required.

Level III—A detailed inspection typically involving nondestructive or partially-destructive testing, conducted to detect hidden or interior damage, or to evaluate material homogeneity.

Typical inspection and testing techniques include the use of ultrasonics, coring or boring, physical material sampling and in-situ hardness testing. Level III testing is generally limited to key structural areas, areas which are suspect, or areas which may be representative of the underwater structure.

3102F.3.5.3 Special Inspection Considerations.

3102F.3.5.3.1 Coated Components. For coated steel components, Level I and Level II efforts should focus on the evaluation of the integrity and effectiveness of the coating. The piles should be inspected without damaging the coating. Level III efforts should include ultrasonic thickness measurements without removal of the coating, where feasible.

3102F.3.5.3.2 Encased Components. For steel, concrete or timber components that have been encased, the Level I and II efforts should focus on the evaluation of the integrity of the encasement. If evidence of significant damage to the encasement is present, or if evidence of significant deterioration of the underlying component is present, then the damage evaluation should consider whether the encasement was provided for protection and/or structural capacity. Encasements should not typically be removed for an Audit.

For encasements on which the formwork has been left in place, the inspection should focus on the integrity of the encasement, not the formwork. Level I and Level II efforts in such cases should concentrate on the top and bottom of the encasement. For concrete components, if deterioration, loss of bonding, or other significant problems with the encasement are suspected, it may be necessary to conduct a Special Inspection, including coring of the encasement and laboratory evaluation of the materials.

4. Oil transfer hoses
5. Fire detection and suppression systems
6. Vapor control system
7. Sumps/sump tanks
8. Vent systems
9. Pumps and pump systems
10. Lighting
11. Communications equipment
12. Gangways
13. Electrical switches and junction boxes
14. Emergency power equipment
15. Air compressors
16. Meters
17. Cathodic protection systems
18. Winches
19. ESD and other control systems
20. Ladders

All alarms, limit switches, load cells, current meters, anemometers, leak detection equipment, etc., shall be operated and/or tested to the extent feasible, to ensure proper function.

3102F.3.6 Evaluation and Assessment.

3102F.3.6.1 Terminal Operating Limits. The physical boundaries of the facility shall be defined by the berthing system operating limits, along with the vessel size limits and environmental conditions.

The Audit shall include a “Statement of Terminal Operating Limits”, which must provide a concise statement of the purpose of each berthing system in terms of operating limits. This description must at least include, the minimum and maximum vessel sizes, including Length Overall (LOA), beam, and maximum draft with associated displacement (see Fig. 31F-2-1).

In establishing limits for both the minimum and maximum vessel sizes, due consideration shall be given to water depths, dolphin spacing, fender system limitations, manifold height and hose/loading arm reach, with allowances for tidal fluctuations, surge and drift.

Maximum wind, current or wave conditions, or combinations thereof, shall be clearly defined as limiting conditions for vessels at each berth, both with and without active product transfer.

3102F.3.6.2 Mooring and Berthing. Mooring and berthing analyses shall be performed in accordance with Section 3105F. The analyses shall be consistent with the terminal operating limits and the structural configuration of the wharf and/or dolphins and associated hardware.

3102F.3.6.3 Structure. A structural evaluation, including a seismic analysis, shall be performed in accordance with Sections 310F3 through 3107F. Such evaluation shall consider local or global reduction in capacity, as determined from the inspection.

Based on inspection results, structural analyses and engineering judgment, CARs shall be assigned on a global basis, independently for above and underwater structures. The CARs defined in Table 31F-2-5 shall be used for this purpose. The CAR documents the structural fitness-for-purpose. Structural component deficiencies may be assigned RAPs as per Table 31F-2-6. The assigned ratings shall remain in effect until all the significant corrective action has been completed to the satisfaction of the Division, or until completion of the next Audit.

**TABLE 31F-2-5
CONDITION ASSESSMENT RATINGS (CAR) [2.3]**

RATING		DESCRIPTION OF STRUCTURAL SYSTEMS, ABOVE AND BELOW WATER LINE
6	Good	No problems or only minor problems noted. Structural elements may show very minor deterioration, but no overstressing observed. The capacity of the structure meets the requirements of this standard. The structure should be considered fit-for-purpose. No repairs or upgrades are required.
5	Satisfactory	Limited minor to moderate defects or deterioration observed, but no overstressing observed. The capacity of the structure meets the requirements of this standard. The structure should be considered fit-for-purpose. No repairs or upgrades are required.
4	Fair	All primary structural elements are sound; but minor to moderate defects or deterioration observed. Localized areas of moderate to advanced deterioration may be present, but do not significantly reduce the load bearing capacity of the structure. The capacity of the structure is no more than 15 percent below the structural requirements of this standard, as determined from an engineering evaluation. The structure should be considered as marginal. Repair and/or upgrade measures may be required to remain operational. Facility may remain operational provided a plan and schedule for remedial action is presented to and accepted by the Division.
3	Poor	Advanced deterioration or overstressing observed on widespread portions of the structure, but does not significantly reduce the load bearing capacity of the structure. The capacity of the structure is no more than 25 percent below the structural requirements of this standard, as determined from an engineering evaluation. The structure is not fit-for-purpose. Repair and/or upgrade measures may be required to remain operational. The facility may be allowed to remain operational on a restricted or contingency basis until the deficiencies are corrected, provided a plan and schedule for such work is presented to and accepted by the Division.
2	Serious	Advanced deterioration, overstressing or breakage may have significantly affected the load bearing capacity of primary structural components. Local failures are possible and loading restrictions may be necessary. The capacity of the structure is more than 25 percent below the structural requirements of this standard, as determined from an engineering evaluation. The structure is not fit-for-purpose. Repairs and/or upgrade measures may be required to remain operational. The facility may be allowed to remain operational on a restricted basis until the deficiencies are corrected, provided a plan and schedule for such work is presented to and accepted by the Division.
1	Critical	Very advanced deterioration, overstressing or breakage has resulted in localized failure(s) of primary structural components. More widespread failures are possible or likely to occur and load restrictions should be implemented as necessary. The capacity of the structure is critically deficient relative to the structural requirements of this standard. The structure is not fit-for-purpose. The facility shall cease operations until deficiencies are corrected and accepted by the Division.

TABLE 31F-2-6
COMPONENT DEFICIENCY REMEDIAL ACTION PRIORITIES (RAP)

REMEDIAL PRIORITIES	DESCRIPTION AND REMEDIAL ACTIONS
P1	Specified whenever a condition that poses an immediate threat to public health, safety or the environment is observed. <u>Emergency Actions</u> may consist of barricading or closing all or portions of the berthing system, evacuating product lines and ceasing transfer operations. The berthing system is not fit-for-purpose. <u>Immediate remedial actions are required prior to the continuance of normal operations.</u>
P2	Specified whenever defects or deficiencies pose a potential threat to public health, safety and the environment. Actions may consist of limiting or restricting operations until remedial measures have been completed. The berthing system is not fit-for-purpose. This priority requires investigation, evaluation and <u>urgent action.</u>
P3	Specified whenever systems require upgrading in order to comply with the requirement of these standards or current applicable codes. These deficiencies <u>do not require emergency or urgent actions.</u> The MOT may have limitations placed on its operational status.
P4	Specified whenever damage or defects requiring repair are observed. The berthing system is fit-for-purpose. <u>Repair can be performed during normal maintenance cycles, but not to exceed one year.</u>
R	Recommended action is a good engineering/maintenance practice, but not required by these standards. The berthing system is fit-for-purpose.

3102F.3.6.4 Mechanical and Electrical Systems. An evaluation of all mechanical and electrical systems and components shall be performed in accordance with Sections 3108F through 3111F of these standards. If a pipeline analysis is required, forces and imposed seismic displacements resulting from the structural analysis shall be considered. Mechanical and electrical component deficiencies shall be assigned ratings from Table 31F-2-6.

3102F.3.7 Follow-up Actions. Structural follow-up actions as described in Table 31F-2-7 shall be prescribed. Multiple follow-up actions may be assigned; however, guidance should be provided as to the order in which the follow-up actions should be carried out.

If a CAR of "1" (Table 31F-2-5) or a RAP of "P1" (Table 31F-2-6) or "Emergency Action" using Table 31F-2-7, is assigned to a berthing system, the Division shall be notified immediately. The audit report shall include implementation schedules for all follow-up and remedial actions. Follow-up and remedial actions and implementation schedules are subject to Division approval. Follow-up actions shall also state the maximum interval before the next audit.

3102F.3.8 Documentation and Reporting. The audit report shall be signed and stamped by the Audit Team Leader.

Each Audit, whether partial or complete, shall be adequately documented. Partial audits cover only specific systems or equipment examined. The resulting report shall summarize and reference relevant previous ratings and deficiencies.

The contents of the audit report for each berthing system shall, at a minimum, include the following as appropriate:

Executive Summary — a concise summary of the audit results and analyses conclusions. It shall include summary information for each berthing system, including an overview of the assigned follow-up actions (See Example Tables ES-1 and ES-2).

Table of Contents

Body of Report

Introduction — a brief description of the purpose and scope of the audit, as well as a description of the inspection/evaluation methodology used for the audit.

Existing Conditions — a brief description, along with a summary of the observed conditions. Subsections should be used to describe the above water structure, underwater structure and mechanical and electrical systems, to the extent each are included in the scope of the audit. Photos, plan views and sketches shall be utilized as appropriate to describe the structure and the observed conditions. Details of the inspection results such as test data, measurements data, etc., shall be documented in an appendix.

Evaluation and Assessment — a CAR shall be assigned to structural systems (above and under water). Mooring and berthing analyses, structural analysis results, and all supporting calculations shall be included in appendices as appropriate to substantiate the ratings. However, the results and recommendations of the engineering analyses shall be included in this section. Component deficiencies should be described and a corresponding RAP assigned.

Follow-up Actions — Specific structural follow-up actions shall be documented (Table 31F-2-7), and remedial schedules included, for each audited system. Audit Team Leaders shall specify which follow-up actions require a California registered engineer to certify that the completion is acceptable.

Appendices — When appropriate, the following appendices shall be included:

1. Background data on the terminal - description of the service environment (wind/waves/currents), extent and type of marine growth, unusual environmental conditions, etc.
2. Inspection/testing data
3. Mooring and berthing analyses
4. Structural and seismic analyses and calculations
5. Geotechnical report
6. MOT Fire Plan
7. Pipeline stress and displacement analyses
8. Mechanical and electrical system documentation
9. Photographs and/or sketches shall be included to document typical conditions and referenced deficiencies, and to justify CARs and RAPs.
10. Condition Assessment Rating (CAR) report and supporting data
11. Remedial Action Priorities (RAP) report and supporting data

3102F.3.9 Action Plan Implementation Report. Within 90 days of completion of the remedial measures (for serious deficiencies, such as P1, P2 or any structural CAR less than 5) specified in the follow-up action plan(s), a report shall be submitted to the Division and shall include:

1. A description of each action taken
2. Updated RAPs and CARs
3. Supporting documentation with calculations and/or relevant data

**TABLE 31F-2-7
STRUCTURAL FOLLOW-UP ACTIONS [2.3]**

FOLLOW-UP ACTION	DESCRIPTION
Emergency Action	Specified whenever a condition which poses an immediate threat to public health, safety or the environment is observed. Emergency Actions may consist of barricading or closing all or portions of the berthing system, limiting vessel size, placing load restrictions, evacuating product lines, ceasing transfer operations, etc.
Engineering Evaluation	Specified whenever structural damage or deficiencies are observed which require further investigation or evaluation to determine appropriate follow-up actions.
Repair Design Inspection	Specified whenever damage or defects requiring repair are observed. The repair design inspection is performed to the level of detail necessary to prepare appropriate repair plans, specifications and estimates.
Upgrade Design and Implementation	Specified whenever the structural system requires upgrading in order to comply with the requirements of these standards and current applicable codes.
Special Inspection	Typically specified to determine the cause or significance of nontypical deterioration, usually prior to designing repairs. Special testing, laboratory analysis, monitoring or investigation using nonstandard equipment or techniques are typically required.
Develop and Implement Repair Plans	Specified when the Repair Design Inspection and required Special Inspections have been completed. Indicates that the structure is ready to have repair plans prepared and implemented.
No Action	Specified when no further action is necessary until the next scheduled audit or inspection.

Example	EXECUTIVE SUMMARY TABLE (ES-1) GLOBAL STRUCTURAL CONDITION ASSESSMENT RATINGS (CAR)						
	BERTHING SYSTEM	SYSTEM	CONDITION ASSESSMENT RATING	FROM THIS AUDIT ¹	FROM PREVIOUS AUDIT ¹	NEXT AUDIT DUE (MO/YR)	ASSIGNED FOLLOW-UP ACTIONS
North Wharf	Above Water Structure	4 (Fair)	4 (date)		6/2004	Upgrade Design and Implementation	No
	Underwater Structure	5 (Satisfactory)		4 (date)	10/2006		Yes
South Wharf	Above Water Structure	4 (Fair)	4 (date)		6/2004	Repair Design Inspection	No
	Underwater Structure	3 (Poor)		4 (date)	10/2006	Special Inspection; Repair Design Inspection	No
Dolphin, Trestle, etc.							

¹Place check mark and date of respective audit in proper column to indicate for each structural system, whether the system was included in the current audit or the results are summarized from a previous audit.

Example	EXECUTIVE SUMMARY TABLE (ES-2) COMPONENT DEFICIENCY REMEDIAL ACTION PRIORITIES (RAP)						
	BERTHING SYSTEM	DEFICIENCY	REMEDIAL ACTION PRIORITY (RAP) (P1-P4)	FROM THIS AUDIT	FROM PREVIOUS AUDIT	NEXT AUDIT DUE (MO/YR)	DESCRIPTION OF PLANNED REMEDIAL ACTION
North Wharf	Fire main leaking	P3		4 (date)	6/2004	Repair	No
	Pipeline badly corroded	P2	4 (date)			Investigate; urgent action required	
	Electrical (Class I, Div 2 violation)	P1	4 (date)			Immediate remedial action required	

3102F.4 Post-Event Inspection. A Post-Event Inspection is a focused inspection following a significant, potentially damage-causing event such as an earthquake, storm, vessel impact, fire, explosion or tsunami. The primary purpose is to assess the integrity of structural, mechanical and electrical systems. This assessment will determine the operational status and/or any remedial measures required.

3102F.4.1 Notification and Action Plan. Notification as per 2 CCR 2325(e) [2.1] shall be provided to the local area Division field office. The notification shall include, as a minimum:

1. Brief description of the event

2. Brief description of the nature, extent and significance of any damage observed as a result of the event
3. Operational status and any required restrictions
4. Statement as to whether a Post-Event Inspection will be carried out

The Division may carry out or cause to be carried out, a Post-Event Inspection. In the interim, the Division may direct a change in the Operations Manual, per 2 CCR 2385 (f)(3) [2.1].

If a Post-Event Inspection is required, an Action Plan shall be submitted to the Division within five (5) days after the event. This deadline may be extended in special circumstances. The Action Plan shall include the scope of the inspection (above water, underwater, electrical, mechanical systems, physical limits, applicable

berthing systems, etc.) and submission date of the final report. The Action Plan is subject to Division approval.

3102F.4.2 Inspection Team. The qualifications of the inspection team shall be the same as those prescribed in Section 3102F.3.4. Division representatives may participate in any Post-Event Inspection, as observers, and may provide guidance.

3102F.4.3 Scope. The Post-Event Inspection shall focus on the possible damage caused by the event. General observations of long-term or preexisting deterioration such as significant corrosion-related damage or other deterioration should be made as appropriate, but should not be the focus of the inspection. The inspection shall always include an above-water assessment of structural, mechanical and electrical components.

The Inspection Team Leader shall determine the need for, and methodology of, an underwater structural assessment, in consultation with the Division. Above water observations, such as shifting or differential settlement, misalignments, significant cracking or spalling, bulging, etc., shall be used to determine whether or not an underwater assessment is required. Similarly, the Inspection Team Leader shall determine, in consultation with the Division, the need for, and methodology of any supplemental inspections (e.g., Special Inspections (see Section 3102F.3.5.3).

The following information may be important in determining the need for, and methodology of, the Post-Event Inspection:

1. Earthquakes or vessel or debris impact typically cause damage both above and below the water line. Following a major earthquake, the inspection should focus on components likely to attract highest lateral loads (batter or shorter piles in the rear of the structure, etc.). In case of vessel or debris impact, the inspection effort should focus on components in the path of the impact mass.
2. Major floods or tsunamis may cause undermining of the structure, and/or scouring at the mud line.
3. Fire damage varies significantly with the type of construction materials but all types may be adversely affected. Special Inspections (sampling and laboratory testing) shall be conducted, as determined by the Inspection Team Leader, in order to determine the nature and extent of damage.
4. High wind or wave events often cause damage both above and below the water line. An underwater inspection may be required if damage is visible above the waterline. Structural damage may be potentially increased if a vessel was at the berth during

the event. The effects of high wind may be most prevalent on equipment and connections of such equipment to the structure.

The methodology of conducting an underwater Post-Event Inspection should be established with due consideration of the structure type and type of damage anticipated. Whereas slope failures or scour may be readily apparent in waters of adequate visibility, overstressing cracks on piles covered with marine growth will not be readily apparent. Where such hidden damage is suspected, marine growth removal should be performed on a representative sampling of components in accordance with the Level II effort requirements described in Section 3102F.3.5.2. The cause of the event will determine the appropriate sample size and locations.

3102F.4.4 Post-Event Ratings. A post-event rating [2.3] shall be assigned to each berthing system upon completion of the inspection (see Table 31F-2-8). All observations of the above and under water structure, mechanical and electrical components and systems shall be considered in assigning a post-event rating.

Ratings should consider only damage that was likely caused by the event. Pre-existing deterioration such as corrosion damage should not be considered unless the structural integrity is immediately threatened or safety systems or protection of the environment may be compromised.

Assignment of ratings should reflect an overall characterization of the berthing system being rated. The rating shall consider both the severity of the deterioration and the extent to which it is widespread throughout the facility. The fact that the facility was designed for loads that are lower than the current standards for design should have no influence upon the ratings.

3102F.4.5 Follow-up Actions. Follow-up actions shall be assigned upon completion of the Post-Event Inspection of each berthing system. Table 31F-2-6 specifies remedial action priorities and actions for mechanical and electrical deficiencies. Table 31F-2-7 specifies various options for structural systems. Multiple follow-up actions may be assigned; however, guidance should be provided as to the order in which the follow-up actions should be carried-out. Follow-up actions shall be subject to Division approval.

3102F.4.6 Documentation and Reporting. Documentation of the specific attributes of each defect shall not be required during a Post-Event Inspection. However, a narrative description of significant damage shall be used. The description shall be consistent with and shall justify the post-event rating assigned.

**TABLE 31F-2-8
POST-EVENT RATINGS AND REMEDIAL ACTIONS [2.3]**

RATING	SUMMARY OF DAMAGE	REMEDIAL ACTIONS
A	No significant event-induced damage observed.	No further action required. The berthing system may continue operations.
B	Minor to moderate event-induced damage observed but all primary structural elements and electrical/mechanical systems are sound.	Repairs or mitigation may be required to remain operational. The berthing system may continue operations.
C	Moderate to major event-induced damage observed which may have significantly affected the load bearing capacity of primary structural elements or the functionality of key electrical/mechanical systems.	Repairs or mitigation may be necessary to resume or remain operational. The berthing system may be allowed to resume limited operations.
D	Major event-induced damage has resulted in localized or widespread failure of primary structural components; or the functionality of key electrical/mechanical systems has been significantly affected. Additional failures are possible or likely to occur.	The berthing system may not resume operations until the deficiencies are corrected.

A report shall be prepared and submitted to the Division upon completion of the Post-Event Inspection and shall, at a minimum, include:

1. Brief description of the facility including the physical limits of the structure, type of construction material(s), and the mechanical and electrical systems present.
2. Brief description of the event triggering the inspection.
3. Scope of the inspection (above water, underwater, electrical or mechanical)
4. Date of the inspection
5. Names and affiliations of inspection team
6. Description of the nature, extent and significance of any observed damage resulting from the event.
7. Photographs should be provided to substantiate the descriptions and justify the condition rating
8. Assignment of a post-event rating
9. Statement regarding whether the facility is fit to resume operations and, if so, under what conditions
10. Assignment of follow-up action(s)
11. Inspection data, drawings, calculations and other relevant engineering materials

12. Signature and stamp of Team Leader(s)

3102F.4.7 Action Plan Report. Upon completion of all actions delineated in the Action Plan, a final report shall be submitted to the Division to document the work completed. Supporting documentation such as calculations or other relevant data shall be provided in appendices.

3102F.5 References.

- [2.1] California Code of Regulations (CCR), Title 2, Division 3, Chapter 1, Article 5, Marine Terminals Inspection and Monitoring, Sections 2315, 2320, 2325 and 2385 (short form example: 2 CCR 2315 (Title 2 of California Code of Regulations, Section 2315).
- [2.2] Buslov, V., Heffron, R. and Martirosyan, A., 2001, "Choosing a Rational Sample Size for the Underwater Inspection of Marine Structures," Proceedings, Ports 2001, ASCE Conference, April 29-May 2, Norfolk, VA.
- [2.3] Childs, K.M., editor, 2001, "Underwater Investigations - Standard Practice Manual," American Society of Civil Engineers, Reston, VA.

Authority: Sections 8755 and 8757, Public Resources Code
Reference: Sections 8750, 8751, 8755 and 8757, Public Resources Code.

EXAMPLE STATEMENT OF TERMINAL OPERATING LIMITS

BERTHING SYSTEM NAME: _____
 FACILITY OWNER/OPERATOR: _____
 FACILITY ADDRESS: _____

DATE: _____
 No. OF TRANSFERS/YEAR: _____
 OIL SPILL AT RISK (BBL): _____
 FACILITY SEISMIC CLASSIFICATION: _____
 FACILITY MOORING/BERTHING CLASSIFICATION: _____
 FACILITY FIRE HAZARD CLASSIFICATION: _____

VESSEL SIZE LIMITS:

ALL MOORING LINES SHALL HAVE A MINIMUM BREAKING STRENGTH OF _____

<p>MAXIMUM VESSEL:</p> <p>LOA _____</p> <p>DWT _____</p> <p>BEAM _____</p> <p>DRAFT _____</p> <p>LBP _____</p> <p>MIN. WATER DEPTH = _____</p> <p>WITH UNDERKEEL CLEARANCE OF _____ (FROM OPERATION MANUAL)</p>	<p>MINIMUM VESSEL:</p> <p>LOA _____</p> <p>DWT _____</p> <p>BEAM _____</p> <p>DRAFT _____</p> <p>LBP _____</p>
--	---

PHYSICAL BOUNDARIES OF BERTHING SYSTEM:

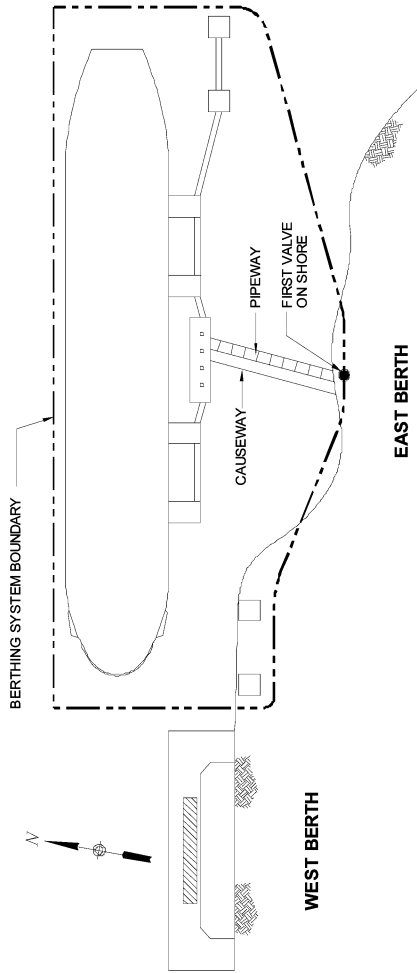

ENVIRONMENTAL CONDITION LIMITS:
 (MUST BE QUALIFIED AND DOCUMENTED BY A MOORING/BERTHING ANALYSIS)

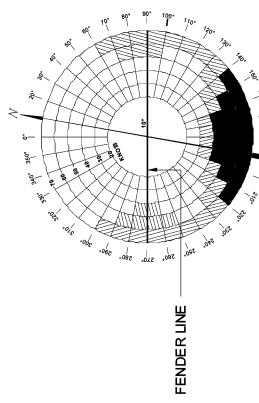

WIND RESTRICTION DIAGRAM

LEGEND:

- TERMINATE PRODUCT TRANSFER
- DISCONNECT PRODUCT LINE AND DEPART BERTH

NOTE: WIND RESTRICTION DIAGRAM IS APPLICABLE WITH MAXIMUM WIND SPEED OF 32 KNOTS, WAVE PERIOD < 40 SECONDS, CHANGE IN DRAFT < 6 FT., AND PASSING VESSEL EFFECTS ARE INSIGNIFICANT.

FIGURE 31F-2-1

Division 3

SECTION 3103F — STRUCTURAL LOADING CRITERIA

3103F.1 General. Section 3103F establishes the environmental and operating loads acting on the Marine Oil Terminal (MOT) structures and on moored vessel(s). The analysis procedures are presented in Sections 3104F - 3107F.

3103F.2 Dead Loads.

3103F.2.1 General. Dead loads shall include the weight of the entire structure, including permanent attachments such as loading arms, pipelines, deck crane, fire monitor tower, gangway structure, vapor control equipment and mooring hardware. Unit weights specified in Section 3103F.2.2 may be used for MOT structures if actual weights are not available.

3103F.2.2 Unit Weights. The unit weights in Table 31F-3-1 may be used for both existing and new MOTs.

**TABLE 31F-3-1
UNIT WEIGHTS**

MATERIAL	UNIT WEIGHT (pcf)*
Steel or cast steel	490
Cast iron	450
Aluminum alloys	175
Timber (untreated)	40-50
Timber (treated)	45-60
Concrete, reinforced (normal weight)	145-160
Concrete, reinforced (lightweight)	90-120
Asphalt paving	150

* pounds per cubic foot

3103F.2.3 Equipment and Piping Area Loads. The equipment and piping area loads in Table 31F-3-2 may be used, as a minimum, in lieu of detailed as-built data.

**TABLE 31F-3-2
EQUIPMENT AND PIPING AREA LOADS**

LOCATION	AREA LOADS (psf)***
Open areas	20*
Areas containing equipment and piping	35**
Trestle roadway	20*

* Allowance for incidental items such as railings, lighting, miscellaneous equipment, etc.

** 35 psf is for miscellaneous general items such as walkways, pipe supports, lighting and instrumentation. Major equipment weight shall be established and added into this weight for piping manifold, valves, deck crane, fire monitor tower, gangway structure and similar major equipment.

*** pounds per square foot

3103F.3 Live Loads and Buoyancy. The following vertical live loading shall be considered, where appropriate: uniform loading, truck loading, crane loading and buoyancy. Additionally, MOT specific, nonpermanent equipment shall be identified and used in loading computations.

3103F.4 Earthquake Loads.

3103F.4.1 General. Earthquake loads are described in terms of Peak Ground Acceleration (PGA), spectral acceleration and earthquake magnitude. The required seismic analysis procedures (Tables 31F-4-2 and 31F-4-3) are dependent on the risk classification obtained from Table 31F-4-1.

3103F.4.2 Design Earthquake Motion Parameters. The earthquake ground motion parameters of peak ground acceleration, spectral acceleration and earthquake magnitude are modified for site amplification and near fault directivity effects. The resulting values are the Design Peak Ground Acceleration (DPGA), Design Spectral Acceleration (DSA) and Design Earthquake Magnitude (DEM).

The peak ground and spectral acceleration may be evaluated using:

1. U.S. Geological Survey (USGS) or California Geological Survey (CGS, formerly the California Division of Mines and Geology (CDMG)) maps as discussed in Section 3103F.4.2.2,

2. A site-specific probabilistic seismic hazard analysis (PSHA) as discussed in Section 3103F.4.2.3.

3. For the Ports of Los Angeles, Long Beach and Port Hueneme, PSHA results are provided in Section 3103F.4.2.3.

Unless stated otherwise, the DSA values are for 5 percent damping; values at other levels may be obtained as per Section 3103F.4.2.9.

The appropriate probability levels associated with DPGA and DSA for different seismic performance levels are provided in Table 31F-4-2. Deterministic earthquake motions, which are used only for comparison to the probabilistic results, are addressed in Section 3103F.4.2.7.

The evaluation of Design Earthquake Magnitude (DEM), is discussed in Section 3103F.4.2.8. This parameter is required when acceleration time histories (Section 3103F.4.2.10) are addressed or if liquefaction potential (Section 3106F.3) is being evaluated.

3103F.4.2.1 Site Classes. The following site classes, defined in Section 3106F.2, shall be used in developing values of DSA and DPGA:

S_A , S_B , S_C , S_D , S_E and S_F .

For S_F , a site-specific response analysis is required per Section 3103F.4.2.5.

3103F.4.2.2 Earthquake Motions from USGS Maps. Earthquake ground motion parameters can be obtained from the Maps 29-32 in the National Earthquake Hazard Reduction Program (NEHRP) design map set discussed in subsection 1.6.1 of [3.1], online at (<http://geohazards.cr.usgs.gov/eq/html/canvmap.html>) or on CD ROM from the USGS. These are available as peak ground acceleration and spectral acceleration values at 5 percent damping for 10 and 2 percent probability of exceedance in 50 years, which correspond to Average Return Periods (ARPs) of 475 and 2,475 years, respectively. The spectral acceleration values are available for 0.2, and 1.0 second spectral periods. In obtaining peak ground acceleration and spectral acceleration values from the USGS web site, the site location can be specified in terms of site longitude and latitude or the zip code when appropriate. The resulting values of peak ground acceleration and spectral acceleration correspond to surface motions for Site Classification approximately corresponding to the boundary of Site Class S_B and S_C .

Once peak ground acceleration and spectral acceleration values are obtained for 10 and 2 percent probability of exceedance in 50 years, the corresponding values for other probability levels may be obtained. A procedure is presented in subsection 1.6 of Chapter 1 of [3.1].

3103F.4.2.3 Earthquake Motions from Site-Specific Probabilistic Seismic Hazard Analyses. Peak ground acceleration and spectral acceleration values can be obtained using site-specific

probabilistic seismic hazard analysis (PSHA). In this approach, the seismic sources and their characterization used in the analysis shall be based on the published data from the California Geological Survey, which can be obtained online at the following web site: (<http://www.consrv.ca.gov/dmg/rghm/psha/Index.htm>) [3.2].

Appropriate attenuation relationships shall be used to obtain values of peak ground acceleration and spectral acceleration at the ground surface for site conditions corresponding to the boundary of Site Class S_B and S_C , regardless of the actual subsurface conditions at the site. These results shall be compared to those based on the FEMA/USGS maps discussed in Section 3103F.4.2.2. If the two sets of values are significantly different, a justification for using the characterization chosen shall be provided.

Alternatively, peak ground acceleration and spectral accelerations at the ground surface for the subsurface conditions that actually exist at the site may be directly obtained by using appropriate attenuation relationships in a site-specific PSHA. This approach is not permissible for Site Classes S_E and S_F .

For site-specific PSHA, peak ground acceleration and spectral acceleration values corresponding to the seismic performance level (See Table 31F-4-2) shall be obtained.

For peak ground acceleration, PSHA may be conducted using the "magnitude weighting" procedure in Idriss [3.3]. The actual magnitude weighting values should follow the Southern California Earthquake Center (SCEC) procedures [3.4]. This magnitude weighting procedure incorporates the effects of duration corresponding to various magnitude events in the PSHA results. The resulting peak ground acceleration shall be used only for liquefaction assessment (see Section 3106F.4).

PSHA have been developed for the Port of Los Angeles, Port of Long Beach and Port Hueneme. This assessment has included a review of onshore and offshore faulting and was performed by Lawrence Livermore National Laboratory [3.5]. Resulting response spectra are provided in Tables 31F-3-3, 31F-3-4 and Figures 31F-3-1 and 31F-3-2. Results are provided only for site classification " S_C " and five percent damping. These spectral values (DSA's) are the minimum acceptable and represent the subsurface only. To obtain appropriate values for piles and/or the mud line, the simplified procedures of Section 3103F.4.2.4 may be used.

3103F.4.2.4 Simplified Evaluation of Site Amplification Effects. When the MOT Site Class is different from the $S_B - S_C$ boundary, site amplification effects shall be incorporated in peak ground accelerations and spectral accelerations. This may be accomplished using a simplified method or a site-specific evaluation (Section 3103F.4.2.5).

For a given Site Class, the following procedure [3.1] presents a simplified method that may be used to incorporate the site amplification effects for peak ground acceleration and spectral acceleration computed for the S_B and S_C boundary.

1. Calculate the spectral acceleration values at 0.20 and 1.0 second period:

$$S_{XS} = F_a S_S \tag{3-1}$$

$$S_{X1} = F_v S_1 \tag{3-2}$$

WHERE:

F_a = site coefficient obtained from Table 31F-3-5

F_v = site coefficient obtained from Table 31F-3-6

S_S = short period (usually at 0.20 seconds) spectral acceleration value (for the boundary of S_B and S_C) obtained using Section 3103F.4.2.2, or at the period corresponding

to the peak in spectral acceleration values when obtained from Section 3103F.4.2.3

S_1 = spectral acceleration value (for the boundary of S_B and S_C) at 1.0 second period

S_{XS} = spectral acceleration value obtained using the short period S_S and factored by Table 31F-3-5 for the Site Class under consideration.

S_{X1} = spectral acceleration value obtained using the 1.0 second period S_1 and factored by Table 31F-3-6 for the Site Class under consideration.

$$2. \text{ Set } PGA_X = 0.4S_{XS} \tag{3-3}$$

WHERE:

PGA_X = peak ground acceleration corresponding to the Site Class under consideration.

When the value of PGA_X is less than the peak ground acceleration obtained following Section 3103F.4.2.2 or Section 3103F.4.2.3, an explanation of the results shall be provided.

3. PGA_X , S_{XS} , and S_{X1} constitute three spectral acceleration values for the Site Class under consideration corresponding to periods of 0, S_S (usually 0.2 seconds), and 1.0 second, respectively.

4. The final response spectra, without consideration for near-fault directivity effects, values of S_a for the Site Class under consideration may be obtained using the following equations (for 5 percent critical damping):

$$\text{for } 0 < T < 0.2T_0 \\ S_a = (S_{XS})(0.4 + 3T/T_0) \tag{3-4}$$

WHERE:

T = Period corresponding to calculated S_a

T_0 = Period at which the constant acceleration and constant velocity regions of the design spectrum intersect

$$\text{for } 0.2T_0 < T < T_0 \\ S_a = S_{XS} \tag{3-5}$$

$$\text{for } T > T_0 \\ S_a = S_{X1}/T \tag{3-6}$$

WHERE:

$$T_0 = S_{X1}/S_{XS} \tag{3-7}$$

The resulting PGA_X is the DPGA. However, the S_a 's (except for the ports of Los Angeles, Long Beach and Port Hueneme) shall be modified for near-fault directivity effects, per Section 3103F.4.2.6 to obtain the final DSAs.

**TABLE 31F-3-3
RESPONSE SPECTRA FOR THE PORTS OF
LOS ANGELES AND LONG BEACH,
475 YEAR RETURN PERIOD (5% Critical Damping)**

SITE CLASS "C" (Shear Wave Velocity from 1220-2500 ft/sec)		
Period (sec)	Frequency (Hz)	Spectral Acceleration (g's)
0.03	33.33	0.47
0.05	20.00	0.52
0.10	10.0	0.71
0.15	6.67	0.86
0.20	5.0	0.93
0.30	3.33	0.93
0.50	2.00	0.85
1.0	1.0	0.62
2.0	0.50	0.37

TABLE 31F-3-4
RESPONSE SPECTRA FOR PORT HUENEME,
475 YEAR RETURN PERIOD (5% Critical Damping)

SITE CLASS "C" (Shear Wave Velocity from 1200-2500 ft/sec)		
Period (sec)	Frequency (Hz)	Spectral Acceleration (g's)
0.03	33.33	0.41
0.05	20.00	0.46
0.10	10.0	0.63
0.15	6.67	0.75
0.20	5.0	0.80
0.30	3.33	0.78
0.50	2.00	0.69
1.0	1.0	0.49
2.0	0.50	0.28

TABLE 31F-3-5
VALUES OF F_a

SITE CLASS	S_S				
	< 0.25	0.5	0.75	1.0	> 1.25
S_A	0.8	0.8	0.8	0.8	0.8
S_B	1.0	1.0	1.0	1.0	1.0
S_C	1.2	1.2	1.1	1.0	1.0
S_D	1.6	1.4	1.2	1.1	1.0
S_E	2.5	1.7	1.2	0.9	0.9
S_F	*	*	*	*	*

NOTE: Linear interpolation can be used to estimate values of F_a for intermediate values of S_S .

* Site-specific dynamic site response analysis shall be performed.

TABLE 31F-3-6
VALUES OF F_v

SITE CLASS	S_I				
	< 0.1	0.2	0.3	0.4	> 0.5
S_A	0.8	0.8	0.8	0.8	0.8
S_B	1.0	1.0	1.0	1.0	1.0
S_C	1.7	1.6	1.5	1.4	1.3
S_D	2.4	2.0	1.8	1.6	1.5
S_E	3.5	3.2	2.8	2.4	2.4
S_F	*	*	*	*	*

NOTE: Linear interpolation can be used to estimate values of F_v for intermediate values of S_I .

* Site-specific dynamic site response analysis shall be performed.

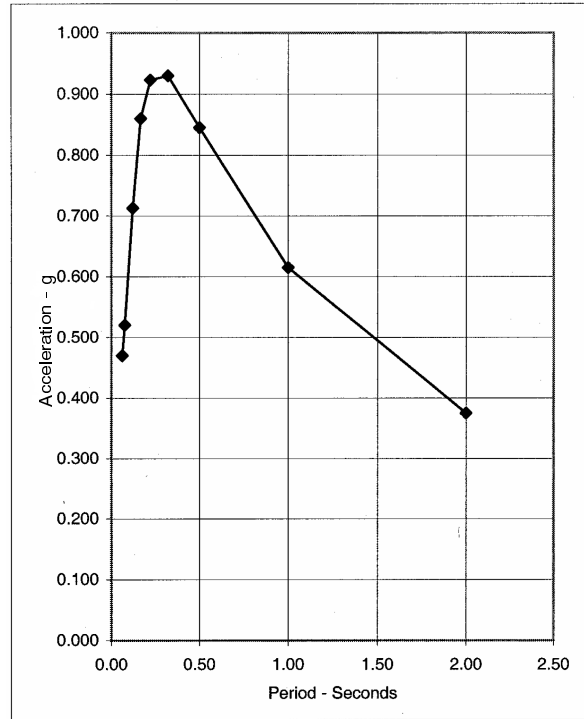

FIGURE 31F-3-1—RESPONSE SPECTRA FOR THE PORTS OF
LOS ANGELES AND LONG BEACH,
475 YEAR RETURN PERIOD (5% Critical Damping)

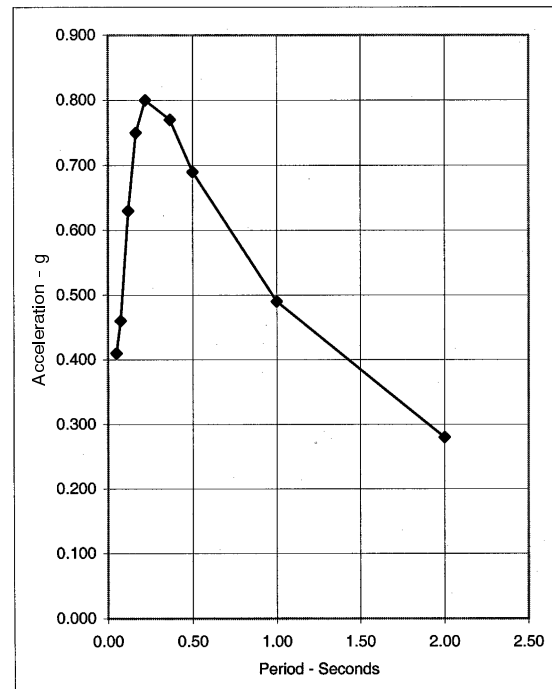

FIGURE 31F-3-2—RESPONSE SPECTRA FOR PORT HUENEME,
475 YEAR RETURN PERIOD (5% Critical Damping)

3103F.4.2.5 Site-Specific Evaluation of Amplification Effects. As an alternative to the procedure presented in Section 3103F.4.2.4, a site-specific response analysis may be performed. For S_r , a site specific response analysis is required. The analysis shall be either an equivalent linear or nonlinear analysis. Appropriate acceleration time histories as discussed in Section 3103F.4.2.10 shall be used.

In general, an equivalent linear analysis using, for example, SHAKE91 [3.6] is acceptable when the strength and stiffness of soils are unlikely to change significantly during the seismic shaking, and the level of shaking is not large. A nonlinear analysis should be used when the strength and/or stiffness of soils could significantly change during the seismic shaking or significant nonlinearity of soils is expected because of high seismic shaking levels.

The choice of the method used in site response analysis shall be justified considering the expected stress-strain behavior of soils under the shaking level considered in the analysis.

Site-specific site response analysis may be performed using one-dimensional analysis. However, to the extent that MOTs often involve slopes or earth retaining structures, the one-dimensional analysis should be used judiciously. When one-dimensional analysis cannot be justified or is not adequate, two-dimensional equivalent linear or nonlinear response analysis shall be performed. Site-specific response analysis results shall be compared to those based on the simplified method of Section 3103F.4.2.4 for reasonableness.

For the port areas of Los Angeles, Long Beach and Port Hueneme, the resulting response spectra shall not fall below values obtained in Section 3103F.4.2.3.

The peak ground accelerations obtained from this site-specific evaluation are DPGAs and the spectral accelerations are DSAs as long as the near-fault directivity effects addressed in Section 3103F.4.2.6 are appropriately incorporated into the time histories (Section 3103F.4.2.10).

3103F.4.2.6 Directivity Effects. When the site is 15 km (9.3 miles) or closer to a seismic source that can significantly affect the site, near-fault directivity effects shall be reflected in the spectral acceleration values and in the deterministic spectral acceleration values of Section 3103F.4.2.7. However, Tables 31F-3-3 and 31F-3-4 for the port areas of Los Angeles, Long Beach and Port Hueneme already have these effects included.

Two methods are available for incorporating directivity effects.

1. Directivity effects may be reflected in the spectral acceleration values in a deterministic manner by using, for example, the equation on pg. 213 (and Tables 6 and 7) of Somerville, et al. [3.7]. The critical seismic sources and their characterization developed as part of the deterministic ground motion parameters (Section 3103F.4.2.7) should be used to evaluate the directivity effects. The resulting adjustments in spectral acceleration values may be applied in the probabilistic spectral acceleration values developed per Section 3103F.4.2.4 or 3103F.4.2.5. Such adjustment can be independent of the probability levels of spectral accelerations.

2. Directivity effects may be incorporated in the results of site-specific PSHA per Section 3103F.4.2.3. In this case, the directivity effects will also depend on the probability level of spectral accelerations.

If spectral accelerations are obtained in this manner, the effects of site amplification using either Section 3103F.4.2.4, 3103F.4.2.5 or an equivalent method (if justified) shall be incorporated.

3103F.4.2.7 Deterministic Earthquake Motions. Deterministic ground motions from “scenario” earthquakes may be used for comparison purposes. Deterministic peak ground accelerations and spectral accelerations may be obtained using the “Critical Seismic Source” with maximum earthquake magnitude and its closest appropriate distance to the MOT. “Critical Seismic Source” is that which results in the largest computed median peak ground acceleration and spectral acceleration values when appropriate attenuation relationships are used. The values obtained from multiple attenuation relationships should be used to calculate the median peak ground acceleration and spectral acceleration values.

Alternatively, the values of peak ground accelerations and spectral accelerations may be obtained from the USGS maps [3.1], corresponding to the Maximum Considered Earthquake (MCE). In this case, the median values of peak ground acceleration and spectral acceleration values shall be 2/3 (see subsection 1.6 of [3.1]) of the values shown on the USGS maps.

3103F.4.2.8 Design Earthquake Magnitude. The Design Earthquake Magnitude used in developing site-specific acceleration time histories (Section 3103F.4.2.10) or liquefaction assessment (Section 3106F.3) is obtained using either of the following two methods.

1. The Design Earthquake may be selected as the largest earthquake magnitude associated with the Critical Seismic Source. The distance shall be taken as the closest distance from the source to the site. The resulting Design Earthquake shall be associated with all DPGA values for the site, irrespective of probability levels.

2. The Design Earthquake (DEQ) may be obtained for each DPGA or DSA value and associated probability level by determining the corresponding dominant distance and magnitude. These are the values of the distance and magnitude that contribute the most to the mean seismic hazards estimates for the probability of interest. They are usually determined by locating the summits of the 3-D surface of contribution of each small interval of magnitude and distance to the total mean hazards estimate. If this 3-D surface shows several modes with approximate weight of more than 20 percent of the total, several DEQs may be considered, and the DEQ leading to the most conservative design parameters shall be used.

3103F.4.2.9 Design Spectral Acceleration for Various Damping Values. Design Spectral Acceleration (DSA) values at damping other than 5 percent shall be obtained by using a procedure given in [3.1], and is denoted as DSA_d . The following procedure does not include near-fault directivity effects.

For $0 < T < 0.2 T_o$

$$DSA_d = S_{XS} [(5/B_S - 2) T / T_o + 0.4] \tag{3-8}$$

For $0.2 T_o < T < T_o$

$$DSA_d = DSA / B_S \tag{3-9}$$

For $T > T_o$

$$DSA_d = S_1 / (B_1 T) \tag{3-10}$$

WHERE:

- T = period
 - T_o = S_{X1} / S_{XS}
 - B_S = Coefficient used to adjust the short period spectral response, for the effect of viscous damping.
 - B_1 = Coefficient used to adjust one-second period spectral response, for the effect of viscous damping
- Values of B_S and B_1 are obtained from Table 31F-3-7.

Such a procedure shall incorporate the near-fault directivity effects when the MOT is 15 km (9.3 miles) or closer to a significant seismic source.

**TABLE 31F-3-7 [3.1]
VALUES OF B_S AND B_I**

DAMPING (%)	B_S	B_I
<2	0.8	0.8
5	1.0	1.0
10	1.3	1.2
20	1.8	1.5
30	2.3	1.7
40	2.7	1.9
>50	3.0	2.0

Note: Linear interpolation should be used for damping values not specifically listed.

3103F.4.2.10 Development of Acceleration Time Histories. When acceleration time histories are utilized, target spectral acceleration values shall be initially selected corresponding to the DSA values at appropriate probability levels. For each set of target spectral acceleration values corresponding to one probability level, at least three sets of horizontal time histories (one or two horizontal acceleration time histories per set) shall be developed.

Initial time histories shall consider magnitude, distance and the type of fault that are reasonably similar to those associated with the conditions contributing most to the probabilistic DSA values. Preferred initial time histories should have their earthquake magnitude and distance to the seismic source similar to the mode-magnitude and mode-distance derived from the PSHA or from appropriate maps. When an adequate number of recorded time histories are not available, acceleration time histories from simulations may be used as supplements.

Scaling or adjustments, either in the frequency domain or in the time domain (preferably), prior to generating acceleration time histories should be kept to a minimum. When the target spectral accelerations include near-fault directivity effects (Section 3103F.4.2.6), the initial time histories should exhibit directivity effects.

When three sets of time histories are used in the analysis, the envelope of the spectral acceleration values from each time history shall be equal to or higher than the target spectral accelerations. If the envelope values fall below the target values, adjustments shall be made to ensure that the spectral acceleration envelope is higher than target spectral accelerations. If the envelope is not higher, then a justification shall be provided.

When seven or more sets of time histories are used, the average of the spectral acceleration values from the set of time histories shall be equal or higher than the target spectral acceleration values. If the average values fall below the target values, adjustments shall be made to ensure that average values are higher than the target spectral accelerations. If this is not the case, then an explanation for the use of these particular spectral acceleration values shall be provided.

When three sets of time histories are used in the analysis, the maximum value of each response parameter shall be used in the design, evaluation and rehabilitation. When seven or more sets of time histories are used in the analysis, the average value of each response parameter may be used.

3103F.5 Mooring Loads on Vessels.

3103F.5.1 General. Forces acting on a moored vessel may be generated by wind, waves, current, tidal variations, tsunamis, seiches and hydrodynamic effects of passing vessels. Forces from wind and current acting directly on the MOT structure (not through the vessel in the form of mooring and/or breasting loads) shall be determined in Section 3103F.7.

The vessel's moorings shall be strong enough to hold during all expected conditions of surge, current and weather and long enough to allow adjustment for changes in draft, drift and tide (2 CCR 2340 (c) (1)) [3.8].

3103F.5.2 Wind Loads. Wind loads on a vessel, moored at a MOT, shall be determined using procedures described in this section. Wind loads shall be calculated for each of the load cases identified in Section 3105F.2.

3103F.5.2.1 Design Wind Speed. The design wind speed is the maximum wind speed of 30-second duration used in the mooring analysis (see Section 3105F).

3103F.5.2.1.1 Operating Condition. The operating condition is the wind envelope in which a vessel may conduct transfer operations. It is determined from the mooring analysis (Section 3105F). Transfer operations shall cease, at an existing MOT, when the wind exceeds the maximum velocity of the envelope.

3103F.5.2.1.2 Survival Condition. The survival condition is defined as the state wherein a vessel can remain safely moored at the berth during severe winds. For new MOTs, the survival condition threshold is the maximum wind velocity, for a 30-second gust and a 25-year return period, obtained from historical data.

For an existing MOT, a reduced survival condition threshold is acceptable (see Figure 31F-2-1). If the wind rises above these levels, the vessel must depart the berth; it shall be able to depart within 30 minutes (see 2 CCR 2340 (c) (28)) [3.8].

The 30-second duration wind speed shall be determined from the annual maximum wind data. Average annual summaries cannot be used. Maximum wind speed data for eight directions (45-degree increments) shall be obtained. If other duration wind data is available, it shall be adjusted to a 30-second duration, in accordance with equation (3.12). The 25-year return period shall be used to establish the design wind speed for each direction. Once these wind speeds are established for each increment, the highest wind speed shall be used to determine the mooring/berthing risk classification, from Table 31F-5-1. In order to simplify the analysis for barges (or other small vessels), they may be considered to be solid free-standing walls (Section 6 of ASCE 7-98 [3.9]). This will eliminate the need to perform a computer assisted mooring analysis.

3103F.5.2.2 Wind Speed Corrections. Wind speed measured at an elevation of 33 feet (10 meters) above the water surface, with duration of 30 seconds shall be used to determine the design wind speed. If these conditions are not met, the following corrections shall be applied.

The correction for elevation is obtained from the equation:

$$V_w = V_h \left(\frac{33}{h} \right)^{1/7} \quad (3-11)$$

WHERE:

V_w = wind speed at elevation 33 ft. (10 m.)

V_h = wind speed at elevation h

h = elevation above water surface of wind data [feet]

The available wind duration shall be adjusted to a 30-second value, using the following formula:

$$V_{t=30 \text{ sec}} = \frac{V_t}{c_t} \quad (3-12)$$

WHERE:

$V_{t=30 \text{ sec}}$ = wind speed for a 30-second duration

V_t = wind speed over a given duration

c_t = conversion factor from Figure 31F-3-3

If wind data is available over land only, the following equation shall be used to convert the wind speed from over-land to over-water conditions [3.10]:

$$V_w = 1.10 V_L \quad (3-13)$$

WHERE:

V_w = over water wind speed

V_L = over land wind speed

3103F.5.2.3 Static Wind Loads on Vessels. The "Prediction of Wind and Current Loads on VLCC's" [3.11] or the "British Standard Code of Practice for Maritime Structures" [3.12] shall be used to determine the wind loads for all tank vessels.

Alternatively, wind loads for any type of vessel may be calculated using the guidelines in Ferritto et al, 1999 [3.13].

3103F.5.3 Current Loads. Environmental loads induced by currents at MOTs shall be calculated as specified in this subsection.

3103F.5.3.1 Design Current Velocity. Maximum ebb and flood currents, annual river runoffs and controlled releases shall be considered when establishing the design current velocities for both existing and new MOTs.

Local current velocities may be obtained from NOAA [3.14] or other sources, but must be supplemented by site-specific data, if the current velocity is higher than 1.5 knots.

Site-specific data shall be obtained by real time measurements over a one-year period. If this information is not available, a safety factor of 1.25 shall be applied to the best available data until real time measurements are obtained.

If the facility is not in operation during annual river runoffs and controlled releases, the current loads may be adjusted.

Operational dates need to be clearly stated in the definition of the terminal operating limits (see Section 3102F.3.6).

3103F.5.3.2 Current Velocity Adjustment Factors. An average current velocity (V_c) shall be used to compute forces and moments. If the current velocity profile is known, the average current velocity can be obtained from the following equation:

$$V_c^2 = 1/T \int_0^T (v_c)^2 ds \quad (3-14)$$

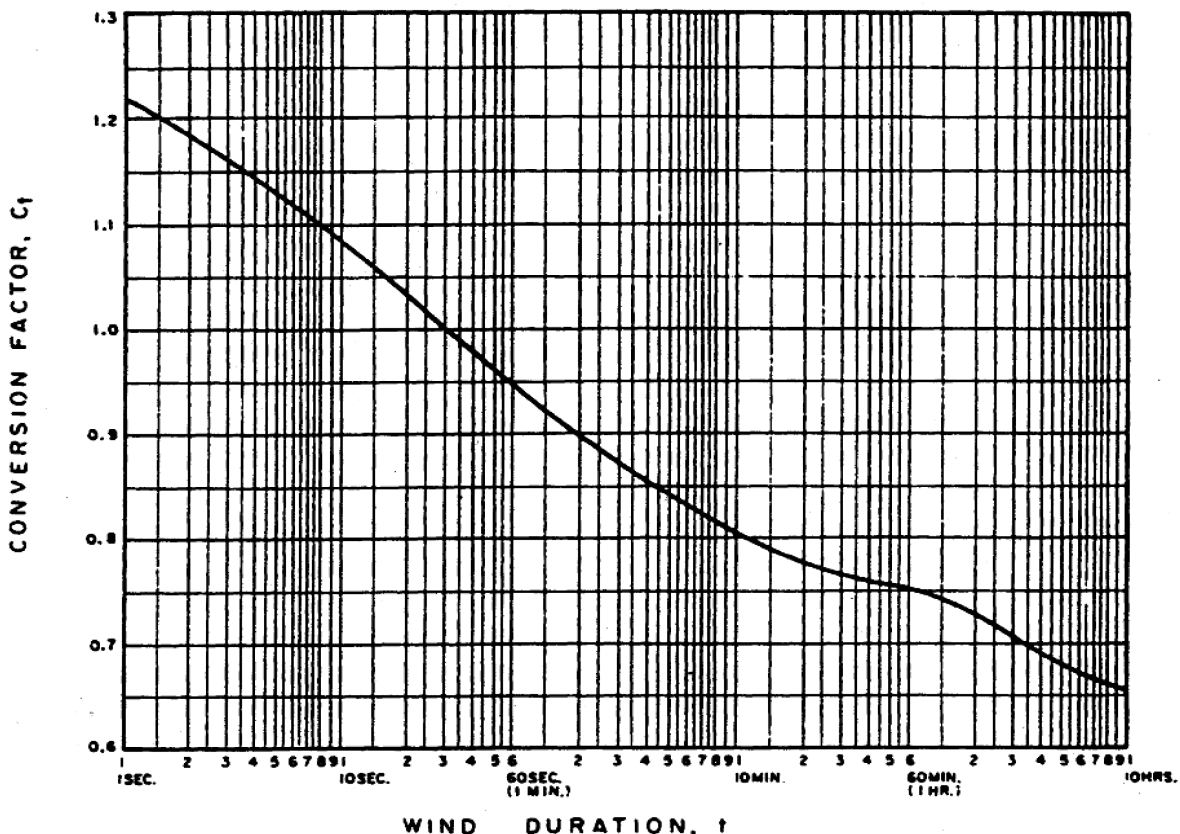

FIGURE 31F-3-3—WINDSPEED CONVERSION FACTOR [3.10]

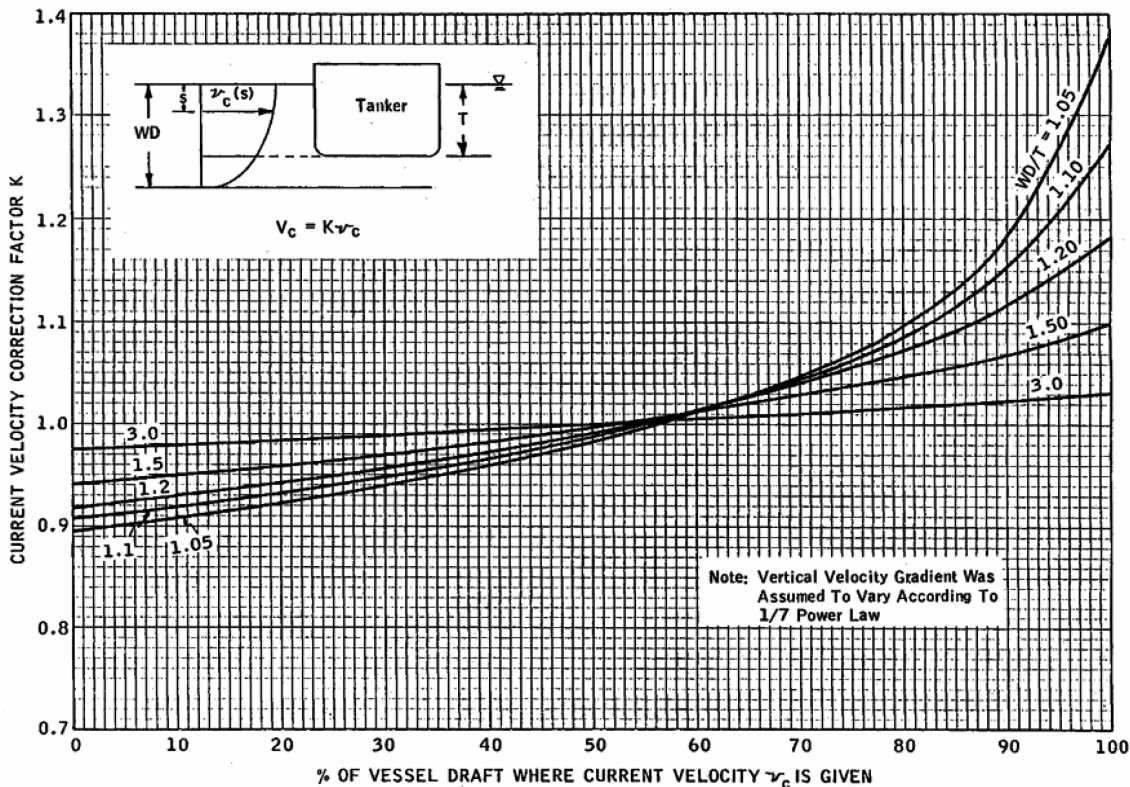

FIGURE 31F-3-4—CURRENT VELOCITY CORRECTION FACTOR (p. 41, OCIMF, 1997 [3.11])

WHERE:

- V_c = average current velocity (knots)
- T = draft of vessel
- v_c = current velocity as a function of depth (knots)
- s = water depth measured from the surface

If the velocity profile is not known, the velocity at a known water depth should be adjusted by the factors provided in Figure 31F-3-4 to obtain the equivalent average velocity over the draft of the vessel.

3103F.5.3.3 Static Current Loads. The OCIMF [3.11], the British Standard [3.12] or the Mil-HDBK-1026/4A [3.15] procedures shall be used to determine current loads for moored tank vessels.

3103F.5.4 Wave Loads. When the significant wave period, T_s , is greater than 4 seconds (See Section 3105F.3.1), the transverse wave induced vessel reactions shall be calculated using a simplified dynamic mooring analysis described below.

The horizontal water particle accelerations shall be calculated for the various wave conditions, taken at the mid-depth of the loaded vessel draft. The water particle accelerations shall then be used to calculate the wave excitation forces to determine the static displacement of the vessel. The Froude-Krylov method discussed in Chakrabarti's Chapter 7 [3.16] may be used to calculate the wave excitation forces, by conservatively approximating the vessel as a rectangular box with dimensions similar to the actual dimensions of the vessel. The horizontal water particle accelerations shall be calculated for the various wave conditions, taken at the mid-depth of the loaded vessel draft. The computed excitation force assumes a 90-degree incidence angle with the longitudinal axis of the vessel, which will result in forces that are significantly greater than the forces that will actually act upon the vessel from quartering seas. A load reduction factor may be used to account for the design wave incidence angle from the longitudi-

nal axis of the ship. The overall excursion of the vessel shall be determined for each of the wave conditions by calculating the dynamic response of the linear spring mass system.

3103F.5.5 Passing Vessels. When required in Section 3105F.3, the sway and surge forces, as well as yaw moment, on a moored vessel, due to passing vessels, shall be established considering the following:

1. Ratio of length of moored vessel to length of passing vessel
2. Distance from moored vessel to passing vessel
3. Ratio of midship section areas of the moored and passing vessels
4. Underkeel clearances of the moored and passing vessels
5. Draft and trim of the moored vessel and draft of the passing vessel
6. Mooring line tensions

The passing vessel's speed should take into consideration the ebb or flood current. Normal operating wind and current conditions can be assumed when calculating forces due to a passing vessel. Any of the following methods may be used to determine forces on a moored vessel: Wang [3.17], Flory [3.18] or Seelig [3.19].

3103F.5.6 Seiche. The penetration of long period low amplitude waves into a harbor can result in resonant standing wave systems, when the wave forcing frequency coincides with a natural frequency of the harbor. The resonant standing waves can result in large surge motions if this frequency is close to the natural frequency of the mooring system. Section 3105F.3.3 prescribes the procedure for the evaluation of these effects.

3103F.5.7 Tsunamis. A tsunami may be generated by an earthquake or a subsea or coastal landslide, which may induce large wave heights and excessive currents. The large wave or surge and

the excessive currents are potentially damaging, especially if there is a tank vessel moored alongside. Table 31F-3-8 provides estimated tsunami run-up values for specific areas of California.

Tsunamis can be generated either by a distant or near source. A tsunami generated by a distant source (far field event) may allow operators to have an adequate warning for mitigating the risk by departing the MOT and going into deep water. For near-field events, with sources less than 500 miles away, the vessel may not have adequate time to depart.

Loads from tsunami-induced waves can be calculated for various structural configurations [3.22]. Tsunami wave heights in shallow water and particle kinematics can also be obtained. Other structural considerations include uplift and debris impact.

**TABLE 31F-3-8
TSUNAMI RUN-UP VALUES [ft] IN CALIFORNIA [3.20], [3.21]**

LOCATION	100 YEAR RETURN PERIOD	500 YEAR RETURN PERIOD
W. Carquinez Strait	3.3	4.0
Richmond Harbor Channel	7.6	13.5
Richmond Inner Harbor	5.9	10.6
Oakland Inner Harbor	4.7-5.5	7.5-9.5
Oakland Middle Harbor	5.9	10.5
Oakland Outer Harbor	7.9-9.1	15.1-17.6
Hunters Point	3.9-5.3	5.0-8.7
San Francisco — S. of Bay Bridge	4.5-5.0	7.5-8.4
Ports of Los Angeles and Long Beach	8.0	15.0
Port Hueneme	11.0	21.0

3103F.6 Berthing Loads.

3103F.6.1 General. Berthing loads are quantified in terms of transfer of kinetic energy of the vessel into potential energy dissipated by the fender(s). The terms and equations below are based on those in Mil-HDBK-1025/1, "Piers and Wharves" [3.23]. An alternate procedure is presented in PIANC [3.24].

Kinetic energy shall be calculated from the following equation:

$$E_{vessel} = \frac{1}{2} \cdot W \cdot V_n^2 \tag{3-15}$$

WHERE:

E_{vessel} = Berthing energy of vessel [ft-lbs]

W = Total weight of vessel and cargo in pounds [long tons × 2240]

g = Acceleration due to gravity [32.2 ft/sec²]

V_n = Berthing velocity normal to the berth [ft/sec]

The following correction factors shall be used to modify the actual energy to be absorbed by the fender system:

$$E_{fender} = C_b \cdot C_m \cdot E_{vessel} \tag{3-16}$$

WHERE:

E_{fender} = Energy to be absorbed by the fender system

C_b = Berthing Coefficient

C_m = Effective mass or virtual mass coefficient (see Section 3103F.6.6)

The berthing coefficient, C_b , is given by:

$$C_b = C_e \cdot C_g \cdot C_d \cdot C_c \tag{3-17}$$

WHERE:

C_e = Eccentricity Coefficient

C_c = Configuration Coefficient

C_g = Geometric Coefficient

C_d = Deformation Coefficient

These coefficients are defined in Sections 3103F.6.2 through 3103F.6.5.

The approximate displacement of the vessel (when only partially loaded) at impact, DT , can be determined from an extension of an equation from Gaythwaite [3.25]:

$$DT = 1.25 DWT(d_{actual}/d_{max}) \tag{3-18}$$

WHERE:

DWT = Dead Weight Tonnage (in long tons)

d_{actual} = Actual arrival draft of the vessel

d_{max} = Maximum loaded vessel draft

The berthing load shall be based on the fender reaction due to the kinetic berthing energy. The structural capacity shall be established based on allowable concrete, steel or timber properties in the structural components, as defined in Section 3107F.

3103F.6.2 Eccentricity Coefficient (C_e). During the berthing maneuver, when the vessel is not parallel to the berthing line (usually the wharf face), not all the kinetic energy of the vessel will be transmitted to the fenders. Due to the reaction from the fender(s), the vessel will start to rotate around the contact point, thus dissipating part of its energy. Treating the vessel as a rigid rod of negligible width in the analysis of the energy impact on the fenders leads to the equation:

$$C_e = \frac{k^2}{a^2 + k^2} \tag{3-19}$$

WHERE:

k = Longitudinal radius of gyration of the vessel [ft]

a = Distance between the vessel's center of gravity and the point of contact on the vessel's side, projected onto the vessel's longitudinal axis [ft]

3103F.6.3 Geometric Coefficient (C_g). The geometric coefficient, C_g , depends upon the geometric configuration of the ship at the point of impact. It varies from 0.85 for an increasing convex curvature to 1.25 for concave curvature. Generally, 0.95 is recommended for the impact point at or beyond the quarter points of the ship, and 1.0 for broadside berthing in which contact is made along the straight side [3.23].

3103F.6.4 Deformation Coefficient (C_d). This accounts for the energy reduction effects due to local deformation of the ships hull and deflection of the whole ship along its longitudinal axis. The energy absorbed by the ship depends on the relative stiffness of the ship and the obstruction. The deformation coefficient varies from 0.9 for a nonresilient fender to nearly 1.0 for a flexible fender. For larger ships on energy-absorbing fender systems, little or no deformation of the ship takes place; therefore, a coefficient of 1.0 is recommended.

3103F.6.5 Configuration Coefficient (C_c). This factor accounts for the difference between an open pier or wharf and a solid pier or wharf. In the first case, the movements of the water surrounding the berthing vessel is not (or is hardly) affected by the berth. In the second case, the water between the berthing vessel and the structure introduces a cushion effect that represents an extra force on the vessel away from the berth and reduces the energy to be absorbed by the fender system.

For open berth and corners of solid piers, $C_c = 1.0$

For solid piers with parallel approach, $C_c = 0.8$

For berths with different conditions, C_c may be interpolated between these values [3.23].

3103F.6.6 Effective Mass or Virtual Mass Coefficient (C_m). In determining the kinetic energy of a berthing vessel, the effective or the virtual mass is the sum of vessel mass and hydrodynamic mass. The hydrodynamic mass does not necessarily vary with the mass of the vessel, but is closely related to the projected area of the vessel at right angles to the direction of motion.

Other factors, such as the form of vessel, water depth, berthing velocity, and acceleration or deceleration of the vessel, will have some effect on the hydrodynamic mass. Taking into account both model and prototype experiments, the effective or virtual mass coefficient can be estimated as:

$$C_m = 1 + 2 \cdot \frac{d_{actual}}{B} \quad (3-20)$$

WHERE:

d_{actual} = Actual arrival draft of the vessel
 B = Beam of vessel

The value of C_m for use in design should be a minimum of 1.5 and need not exceed 2.0 [3.23].

3103F.6.7 Berthing Velocity and Angle. The berthing velocity, V_n , is influenced by a large number of factors such as environmental conditions of the site (wind, current and wave), method of berthing (with or without tugboat assistance), condition of the vessel during berthing (ballast or fully laden) and human factors (experience of the tugboat captain.).

The berthing velocity, normal to berth, shall be in accordance with Table 31F-3-9, for existing berths. Site condition is determined from Table 31F-3-10. For new berths, the berthing velocity, V_n , is established according to Table 4.2.1 of the PIANC guidelines [3.24].

Subject to Division approval, if an existing MOT can demonstrate lower velocities by velocity monitoring equipment, then such a velocity may be used.

In order to obtain the normal berthing velocity, V_n , an approach angle, defined as the angle formed by the fender line and the longitudinal axis of the vessel must be determined. The berthing angles, used to compute the normal berthing velocity, for various vessel sizes are shown in Table 31F-3-11.

tudinal axis of the vessel must be determined. The berthing angles, used to compute the normal berthing velocity, for various vessel sizes are shown in Table 31F-3-11.

**TABLE 31F-3-11
MAXIMUM BERTHING ANGLE**

VESSEL SIZE (DWT)	ANGLE [degrees]
Barge	15
<10,000	10
10,000-50,000	8
>50,000	6

3103F.7 Wind And Current Loads On Structures.

3103F.7.1 General. This section provides methods to determine the wind and current loads acting on the structure directly, as opposed to wind and current forces acting on the structure from a moored vessel.

3103F.7.2 Wind Loads. Section 6 of ASCE 7 [3.9] shall be used to establish minimum wind loads on the structure. Additional information about wind loads may be obtained from Simiu and Scanlan [3.26].

3103F.7.3 Current Loads. The current forces acting on the structure may be established using the current velocities, per Section 3103F.5.3.

3103F.8 Load Combinations. Each component of the structure shall be analyzed for all applicable load combinations given in Table 31F3-12 or 31F-3-13, depending on component type.

The “vacant condition” is the case wherein there is no vessel at the berth. The “mooring and breasting condition” exists after the vessel is securely tied to the wharf. The “berthing condition” occurs as the vessel impacts the wharf, and the “earthquake condition” assumes no vessel is at the berth, and there is no wind or current forces on the structure.

The use of various load types is discussed below:

**TABLE 31F-3-9
BERTHING VELOCITY V_n (NORMAL TO BERTH)**

VESSEL SIZE (dwt)	TUG BOAT ASSISTANCE	SITE CONDITIONS		
		Unfavorable	Moderate	Favorable
<10,000 ¹	No	1.31 ft/sec	0.98 ft/sec	0.53 ft/sec
10,000 - 50,000	Yes	0.78 ft/sec	0.66 ft/sec	0.33 ft/sec
50,000 - 100,000	Yes	0.53 ft/sec	0.39 ft/sec	0.26 ft/sec
>100,000	Yes	0.39 ft/sec	0.33 ft/sec	0.26 ft/sec

¹If tug boat is used for vessel size smaller than 10,000 DWT the berthing velocity may be reduced by 20%

**TABLE 31F-3-10
SITE CONDITIONS**

SITE CONDITIONS	DESCRIPTION	WIND SPEED ¹	SIGNIFICANT WAVE HEIGHT	CURRENT SPEED ²
Unfavorable	Strong Wind Strong Currents High Waves	>38 knots	>6.5 ft	>2 knots
Moderate	Strong Wind Moderate Current Moderate Waves	≥38 knots	≤6.5 ft	≤2 knots
Favorable	Moderate Wind Moderate Current Moderate Waves	<38 knots	<6.5 ft	<2 knots

¹A 30-second duration measured at a height of 33 ft.

²Taken at 0.5 x water depth

3103F.8.1 Dead Load (D). Upper and lower bound values of dead load are applied for the vacant condition to check the maximum moment and shear with minimum axial load.

3103F.8.2 Live Load (L). The live load on MOTs is typically small and is therefore neglected for combinations including earthquake loads.

3103F.8.3 Buoyancy Load (B). Buoyancy forces shall be considered for any submerged or immersed substructures (including pipelines, sumps and structural components).

3103F.8.4 Wind (W) and Current (C) on the Structure. Wind and currents on the vessel are included in the mooring and breasting condition. The wind and current loads acting on the structure are therefore additional loads that can act simultaneously with the mooring, breasting and/or berthing loads.

3103F.8.5 Earth Pressure on the Structure (H). The soil pressure on end walls, typically concrete cut-off walls, steel sheet pile walls on wharf type structures and/or piles shall be considered.

3103F.8.6 Mooring Line/Breasting Loads (M). Mooring line and breasting loads can occur simultaneously or individually, depending on the combination of wind and current. Multiple load cases for operating and survival conditions may be required (see Sections 3103F.5.2 and 3105F.2). In addition, loads caused by passing vessels shall be considered for the “mooring and breasting condition”. Refer to Sections 3105F.2 and 3105F.3 for the determination of mooring line and breasting loads.

3103F.8.7 Berthing Load (Be). Berthing is a frequent occurrence, and shall be considered as a normal operating load. No increase in allowable stresses shall be applied for ASD, and a load factor of 1.7 shall be applied for the LRFD approach.

3103F.8.8 Earthquake Loads (E). In LRFD or performance based design, use a load factor of 1.0; for ASD use 0.7. A load factor of 1.0 shall be assigned to the earthquake loads. Performance based seismic analysis methodology requires that the actual force demand be limited to defined strains in concrete, steel and timber. For the deck and pile evaluation, two cases of dead load (upper and lower bound) shall be considered in combination with the seismic load.

3103F.9 Safety Factors For Mooring Lines. Safety factors for different material types of mooring lines are given in Table 31F-3-14. The safety factors should be applied to the minimum number of lines specified by the mooring analysis, using the highest loads calculated for the environmental conditions. The minimum breaking load (mbl) of new ropes is obtained from the certificate issued by the manufacturer. If nylon tails are used in combination with steel wire ropes, the safety factor shall be based on the weaker of the two ropes.

3103F.10 Mooring Hardware. Marine hardware consists of quick release hooks, other mooring fittings and base bolts. The certificate issued by the manufacturer normally defines the allowable working loads of this hardware.

**TABLE 31F-3-12
LRFD LOAD FACTORS FOR LOAD COMBINATIONS [3.13]**

LOAD TYPE	VACANT CONDITION	MOORING & BREASTING CONDITION	BERTHING CONDITION	EARTHQUAKE CONDITION
Dead Load (D)	1.4 ¹	1.2	1.2	1 ± k ³
Live Load (L)	1.7 ²	1.7 ²		
Buoyancy (B)	1.3	1.3	1.3	
Wind on Structure (W)	1.3	1.3	1.0	
Current on Structure (C)	1.3	1.3	1.0	
Earth Pressure on the Structure (H)	1.6	1.6	1.6	1.0
Mooring/Breasting Load (M)		1.3		
Berthing Load (Be)			1.7	
Earthquake Load (E)				1.0

¹Reduce load factor for dead load (D) to 0.9 to check components for minimum axial load and maximum moment.

²The load factor for live load (L) may be reduced to 1.3 for the maximum outrigger float load from a truck crane.

³k = 0.50 (PGA)

**TABLE 31F-3-13
SERVICE OR ASD LOAD FACTORS FOR LOAD COMBINATIONS**

LOAD TYPE	VACANT CONDITION	MOORING & BREASTING CONDITION	BERTHING CONDITION	EARTHQUAKE CONDITION
Dead Load (D)	1.0	1.0	1.0	1 ± 0.7k ¹
Live Load (L)	1.0	1.0		
Buoyancy (B)	1.0	1.0	1.0	
Wind on Structure (W)	1.0	1.0	1.0	
Current on Structure (C)	1.0	1.0	1.0	
Earth Pressure on the structure (H)	1.0	1.0	1.0	1.0
Mooring/Breasting Load (M)		1.0		
Berthing Load (Be)			1.0	
Earthquake Load (E)				0.7
% Allowable Stress	100	100	100	133

¹k = 0.5 (PGA)

TABLE 31F-3-14
SAFETY FACTORS FOR ROPES*

Steel Wire Rope	1.82
Nylon	2.2
Other Synthetic	2.0
Polyester Tail	2.3
Nylon Tail	2.5

*From Mooring Equipment Guidelines, OCIMF[3.27]

3103F.10.1 Quick Release Hooks. For new MOTs, a minimum of three quick-release hooks are required for each breasting line location for tankers larger than 50,000 DWT. At least two hooks at each location shall be provided for breasting lines for tankers less than 50,000 DWT.

All hooks shall withstand the minimum breaking load (MBL) of the strongest line with a Safety Factor of 1.2 or greater. Only one mooring line shall be placed on each quick release hook.

3103F.10.2 Other Fittings. Other fittings include cleats, bitts and bollards.

If the allowable working loads for existing fittings are not available, the values listed in Table 31F-3-15 may be used for typical sizes, bolt patterns and layout. The allowable working loads are defined for mooring line angles up to 60 degrees from the horizontal. The combination of vertical and horizontal loads must be considered.

TABLE 31F-3-15
ALLOWABLE WORKING LOADS

TYPE OF FITTINGS	NO. OF BOLTS	BOLT SIZE (in)	WORKING LOAD (kips)
30 in. Cleat	4	1 ¹ / ₈	20
42 in. Cleat	6	1 ¹ / ₈	40
Low Bitt	10	1 ⁵ / ₈	60 per column
High Bitt	10	1 ³ / ₄	75 per column
44 ¹ / ₂ in. Ht. Bollard	4	1 ³ / ₄	70
44 ¹ / ₂ in. Ht. Bollard	8	2 ¹ / ₄	200
48 in. Ht. Bollard	12	2 ³ / ₄	450

Note: This table is modified from Table 48, MIL-HDBK-1026/4A [3.15]

3103F.10.3 Base Bolts. Base bolts are subjected to both shear and uplift. Forces on bolts shall be determined using the following factors:

1. Height of load application on bitts or bollards.
2. Actual vertical angles of mooring lines for the highest and lowest tide and vessel draft conditions, for all sizes of vessels at each particular berth
3. Actual horizontal angles from the mooring line configurations, for all vessel sizes and positions at each particular berth
4. Simultaneous loads from more than one vessel

For existing MOTs, the deteriorated condition of the base bolts and supporting members shall be considered in determining the capacity of the fitting.

3103F.11 Miscellaneous Loads. Handrails and guardrails shall be designed for 25 plf with a 200-pound minimum concentrated load in any location or direction.

3103F.12 Symbols.

- a = Distance between the vessel's center of gravity and the point of contact on the vessel's side, projected onto the vessel's longitudinal axis [ft]
- B = Beam of vessel
- B_1 = Coefficient used to adjust one-second period spectral response, for the effect of viscous damping
- B_s = Coefficient used to adjust the short period spectral response, for the effect of visous damping.
- C_b = Berthing Coefficient
- C_c = Configuration Coefficient
- C_g = Geometric Coefficient
- C_d = Deformation Coefficient
- C_e = Eccentricity Coefficient
- C_m = Effective mass or virtual mass coefficient
- C_t = Windspeed conversion factor
- DSA = Design Spectral Acceleration
- DSA_d = DSA values at damping other than 5 percent
- DT = Displacement of vessel
- DWT = Dead weight tons
- d_{actual} = Arrival maximum draft of vessel at berth
- d_{max} = Maximum vessel draft (in open seas)
- E_{fender} = Energy to be absorbed by the fender system
- E_{vessel} = Berthing energy of vessel [ft-lbs]
- F_a, F_v = Site coefficients from Tables 31F-3-5 and 31F-3-6
- g = Acceleration due to gravity [32.2 ft/sec²]
- h = Elevation above water surface [feet]
- K = Current velocity correction factor (Fig 31F-3-4)
- k = Radius of longitudinal gyration of the vessel [ft]
- PGA_X = Peak ground acceleration corresponding to the Site Class under consideration.
- s = Water depth measured from the surface
- S_a = Spectral acceleration
- S_1 = Spectral acceleration value (for the boundary of S_B and S_C) at 1.0 second
- S_A-S_F = Site classes as defined in Table 31F-6-1
- S_S = Spectral acceleration value (for the boundary of S_B and S_C) at 0.2
- S_{X1} = Spectral acceleration value at 1.0 second corresponding to the Site Class under consideration
- S_{XS} = Spectral acceleration value at 0.2 second corresponding to the period of S_S and the Site Class under consideration
- T = Draft of vessel (see Fig 31F-3-4)
- T = Period (Sec)
- T_o = Period at which the constant acceleration and constant velocity regions of the design spectrum intersect
- V_c = Average current velocity [knots]
- v_c = Current velocity as a function of depth [knots]
- V_h = Wind speed (knots) at elevation h
- V_L = Over land wind speed
- V_n = Berthing velocity normal to the berth [ft/sec]
- v_t = Velocity over a given time period
- $V_{t=30\ sec}$ = Wind speed for a 30 second interval
- V_w = Wind speed at 33 ft. (10 m) elevation [knots]

W = Total weight of vessel and cargo in pounds [displacement tonnage \times 2240]

WD = Water Depth (Fig 31F-3-4)

3103F.13 References.

- [3.1] Federal Emergency Management Agency, FEMA-356, Nov. 2000, "Prestandard and Commentary for the Seismic Rehabilitation of Buildings," Washington, D.C.
- [3.2] California Geological Survey, 1998, "Probabilistic Seismic Hazard Map of California," (website: www.consrv.ca.gov/dmg/rghm/psha/index.htm), Sacramento, CA.
- [3.3] Idriss, I.M., August 1985, "Evaluating Seismic Risk in Engineering Practice," Proceedings, Theme Lecture No. 6, XI International Conference on Soil Mechanics and Foundation Engineering, San Francisco, CA, vol. I, pp. 255-320.
- [3.4] Southern California Earthquake Center (SCEC), March 1999, "Recommended Procedures for Implementation of DMG Special Publication 117 Guidelines for Analyzing and Mitigating Liquefaction in California," University of Southern California, Los Angeles.
- [3.5] Savy, J. and Foxall, W., 2002, "Probabilistic Seismic Hazard Analysis for Southern California Coastal Facilities," 2003, Lawrence Livermore National Laboratory.
- [3.6] Idriss, I.M. and Sun, J.I., 1992, "User's Manual for SHAKE91, A Computer Program for Conducting Equivalent Linear Seismic Response Analyses of Horizontally Layered Soil Deposits," Center for Geotechnical Modeling, Department of Civil and Environmental Engineering, University of California, Davis, CA.
- [3.7] Somerville, Paul G., Smith, Nancy F., Graves, Robert W., and Abrahamson, Norman A., 1997, "Modification of Empirical Strong Ground Motion Attenuation Relations to Include the Amplitude and Duration Effects of Rupture Directivity", *Seismological Research Letters*, Volume 68, Number 1, pp.199 - 222.
- [3.8] California Code of Regulations, "Marine Terminals, Inspection and Monitoring," Title 2, Division 3, Chapter 1, Article 5. California State Lands Commission, Sacramento, CA.
- [3.9] American Society of Civil Engineers, Jan. 2000, "Minimum Design Loads for Buildings and Other Structures," ASCE 7-98, Revision of ANSI/ASCE 9-95, Reston, VA.
- [3.10] Pile Buck Production, 1992, "Mooring Systems," Pile Buck Inc., Jupiter, Florida.
- [3.11] Oil Companies International Marine Forum (OCIMF), 1977, "Prediction of Wind and Current Loads on VLCCs," London, England.
- [3.12] British Standards Institution, 2000, "British Standard Code of Practice for Maritime Structures - Part 1 General Criteria" BS6349, Part 1, London, England.
- [3.13] Ferritto, J., Dickenson, S., Priestley N., Werner, S., Taylor, C., Burke D., Seelig W., and Kelly, S., 1999, "Seismic Criteria for California Marine Oil Terminals," Vol. 1 and Vol. 2, Technical Report TR-2103-SHR, Naval Facilities Engineering Service Center, Port Hueneme, CA.
- [3.14] National Oceanic and Atmospheric Administration, Contact: National PORTS Program Manager, Center for Operational Oceanographic Products and Services, 1305 EW Highway, Silver Spring, MD 20910, web page: http://co-ops.nos.noaa.gov/d_ports.html
- [3.15] Dept. of Defense, 1 July 1999, "Mooring Design," Mil-HDBK-1026/4A, Washington, D.C.
- [3.16] Chakrabarti, S. K., 1987, "Hydrodynamics of Offshore Structures," *Computational Mechanics*.
- [3.17] Wang, Shen, August 1975, "Dynamic Effects of Ship Passage on Moored Vessels," *Journal of the Waterways, Harbors and Coastal Engineering Division, Proceedings of the American Society of Civil Engineers*, Vol. 101, WW3, Reston, VA.
- [3.18] Flory, John F., 2001, "A Method for Estimating Passing Ship Effects," *Proceedings, Ports 2001, ASCE Conference April 29-May 2, Norfolk, Virginia*.
- [3.19] Seelig, William N., 20 November 2001, "Passing Ship Effects on Moored Ships," *Technical Report TR-6027-OCN, Naval Facilities Engineering Service Center, Washington, D.C.*
- [3.20] Garcia, A. W. and Houston, J. R., November, 1975, "Type 16 Flood Insurance Study: Tsunami Predictions for Monterey and San Francisco Bays and Puget Sound," *Technical Report H-75-17, U.S. Army Engineer Waterways Experiment Station, Vicksburg, MS*.
- [3.21] Synolakis, C., "Tsunami and Seiche," Chapter 9 in *Earthquake Engineering Handbook*, Chen, W., Scawthorn, C. S. and Arros, J. K., editors, 2002, CRC Press, Boca Raton, FL.
- [3.22] Camfield, Frederick E., February 1980, "Tsunami Engineering," U.S. Army, Corps of Engineers, Coastal Research Center, Special Report No. 6.
- [3.23] Dept. of Defense, 30 June 1994, *Military Handbook, "Piers and Wharves," Mil-HDBK-1025/1, Washington, D.C.*
- [3.24] Permanent International Association of Navigation Congresses (PIANC), 2002, "Guidelines for the Design of Fender Systems: 2002," Brussels.
- [3.25] Gaythwaite, John, 2004, "Design of Marine Facilities for the Berthing, Mooring and Repair of Vessels," *American Society of Civil Engineers, Reston, VA*.
- [3.26] Simiu E. and Scanlan R., 1978, "Wind Effects on Structures: An Introduction to Wind Engineering," *Wiley-Interscience Publications, New York*.
- [3.27] Oil Companies International Marine Forum (OCIMF), 1997, "Mooring equipment Guidelines," 2nd ed., London, England.

Authority: Sections 8755 and 8757, Public Resources Code.
Reference: Sections 8750, 8751, 8755 and 8757, Public Resources Code.

Division 4

SECTION 3104F — SEISMIC ANALYSIS AND STRUCTURAL PERFORMANCE

3104F.1 General.

3104F.1.1 Purpose. The purpose of this Section is to establish minimum standards for seismic analysis and structural performance. Seismic performance is evaluated at two criteria levels. Level 1 requirements define a performance criterion to ensure MOT functionality. Level 2 requirements safeguard against major structural damage or collapse.

3104F.1.2 Applicability. Section 3104F applies to all new and existing MOTs structures. Structures supporting loading arms, pipelines, oil transfer and storage equipment, critical nonstructural systems and vessel mooring structures, such as mooring and breasting dolphins are included. Catwalks and similar components that are not part of the lateral load carrying system and do not support oil transfer equipment may be excluded.

3104F.1.3 Oil Spill Risk Classification. Each existing MOT shall be categorized into one of three risk classifications (high, medium or low) as shown in Table 31F-4-1, based on the highest of the following:

1. Exposed total volume of oil during transfer (“total volume” as calculated in Section 3108F.2.3)
2. Number of oil transfer operations per berthing system per year
3. Maximum vessel size (DWT) that may call at the berthing system

If risk reduction strategies (see Section 3101F.5) are adopted such that the maximum volume of exposed oil during transfer is less than 1,200 barrels, the classification level of the facility may be lowered. All new MOTs are classified as high risk.

3104F.1.4 Configuration Classification. Each MOT shall be designated as regular or irregular, in accordance with Figure 31F-4-1.

Irregular configurations, such as the “T” layout, may be analyzed as regular if the presence of expansion joints divides the T-configuration into two or more regular segments. Expansion joints in this context are defined as joints that separate each structural segment in such a manner that each segment will move independently during an earthquake.

If an irregular MOT is divided into seismically isolated sections, an evaluation of the relative movement of pipelines and supports shall be considered, including phase differences (Section 3109F.3).

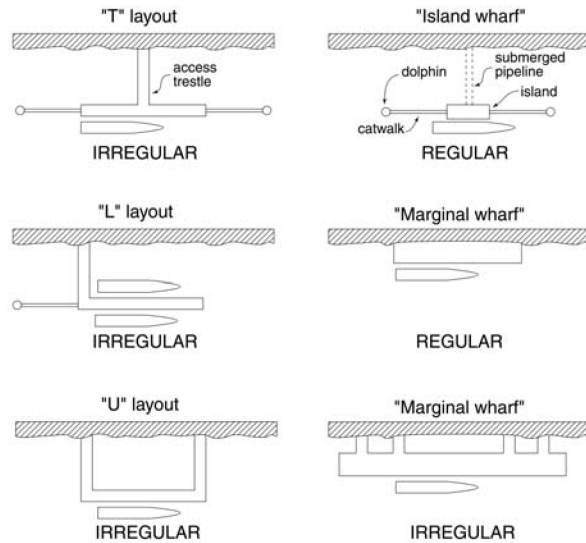

FIGURE 31F-4-1—PIER AND WHARF CONFIGURATIONS

3104F.2 Existing MOTs

3104F.2.1 Design Earthquake Motions. Two levels of design seismic performance shall be considered. These levels are defined as follows:

Level 1 Seismic Performance:

- Minor or no structural damage
- Temporary or no interruption in operations

Level 2 Seismic Performance:

- Controlled inelastic structural behavior with repairable damage
- Prevention of structural collapse
- Temporary loss of operations, restorable within months
- Prevention of major spill (≥ 1200 bbls)

3104F.2.2 Basis for Evaluation. Component capacities shall be based on existing conditions, calculated as “best estimates,” taking into account the mean material strengths, strain hardening and degradation over time. The capacity of components with little or no ductility, which may lead to brittle failure scenarios, shall be calculated based on lower bound material strengths. Methods to establish component strength and deformation capacities for typical structural materials and components are provided in Section 3107F. Geotechnical considerations are discussed in Section 3106F.

TABLE 31F-4-1
MOT RISK CLASSIFICATION

RISK CLASSIFICATION	EXPOSED OIL (bbls)	TRANSFERS PER YEAR PER BERTHING SYSTEM	MAXIMUM VESSEL SIZE (DWTx1000)
High	≥ 1200	N.A.	N.A.
Medium	< 1200	≥ 90	≥ 30
Low	< 1200	< 90	< 30

3104F.2.3 Analytical Procedures. The objective of the seismic analysis is to verify that the displacement capacity of the structure is greater than the displacement demand, for each performance level defined in Table 31F-4-2. The required analytical procedures are summarized in Table 31F-4-3.

The displacement capacity of the structure shall be calculated using the nonlinear static (pushover) procedure. It is also acceptable to use a nonlinear dynamic procedure for capacity evaluation. Methods used to calculate the displacement demand are linear modal, nonlinear static and nonlinear dynamic.

Any rational method, subject to the Division's approval, can be used in lieu of the required analytical procedures shown in Table 31F-4-3.

3104F.2.3.1 Nonlinear Static Capacity Procedure (Pushover). Two-dimensional nonlinear static (pushover) analyses shall be performed; three-dimensional analyses are optional. A model that incorporates the nonlinear load deformation characteristics of all components for the lateral force-resisting system shall be displaced to a target displacement to determine the internal deformations and forces. The target displacement depends on the seismic performance level under consideration. Modeling details are as follows:

3104F.2.3.1.1 Modeling. A series of nonlinear pushover analyses may be required depending on the complexity of the MOT structure. At a minimum, pushover analysis of a two-dimensional model shall be conducted in both the longitudinal and transverse directions. The piles shall be represented by nonlinear elements that capture the moment-curvature/rotation relationships for components with expected inelastic behavior in accordance with Section 3107F. A nonlinear element is not required to represent each pile location. Piles with similar lateral force-deflection behavior may be lumped in fewer larger springs, provided that the overall torsional effects are captured.

Linear material component behavior is acceptable where nonlinear response will not occur. All components shall be based on effective moment of inertia calculated in accordance with Section 3107F. Specific requirements for timber pile structures are discussed in the next section.

3104F.2.3.1.2 Timber Pile Supported Structures. For all timber pile supported structures, linear elastic procedures may be used. Alternatively, the nonlinear static procedure may be used to estimate the target displacement demand, Δ_t .

A simplified single pile model for a typical timber pile supported structure is shown in Figure 31F-4-2. The pile-deck connections may be assumed to be "pinned". The lateral bracing can often be ignored if it is in poor condition. These assumptions shall be used for the analysis, unless a detailed condition assessment and lateral analysis indicate that the existing bracing and connections may provide reliable lateral resistance.

A series of single pile analyses may be sufficient to establish the nonlinear springs required for the pushover analysis.

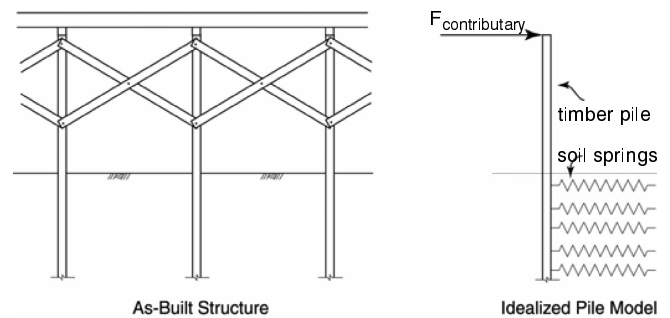

FIGURE 31F-4-2—SIMPLIFIED SINGLE PILE MODEL OF A TIMBER PILE SUPPORTED STRUCTURE

TABLE 31F-4-2
SEISMIC PERFORMANCE CRITERIA

RISK CLASSIFICATION	SEISMIC PERFORMANCE LEVEL	PROBABILITY OF EXCEEDANCE	RETURN PERIOD
High	Level 1	50% in 50 years	72 years
	Level 2	10% in 50 years	475 years
Medium	Level 1	65% in 50 years	48 years
	Level 2	15% in 50 years	308 years
Low	Level 1	75% in 50 years	36 years
	Level 2	20% in 50 years	224 years

TABLE 31F-4-3
MINIMUM REQUIRED ANALYTICAL PROCEDURES

RISK CLASSIFICATION	CONFIGURATION	SUBSTRUCTURE MATERIAL	DISPLACEMENT DEMAND PROCEDURE	DISPLACEMENT CAPACITY PROCEDURE
High/Medium	Irregular	Concrete/Steel	Linear Modal	Nonlinear Static
High/Medium	Regular	Concrete/Steel	Nonlinear Static	Nonlinear Static
Low	Regular/Irregular	Concrete/Steel	Nonlinear Static	Nonlinear Static
High/Medium/Low	Regular/Irregular	Timber	Nonlinear Static	Nonlinear Static

3104F.2.3.1.3 Soil-Structure Interaction (SSI). Load-deformation characteristics for foundations shall be modeled as per Section 3106F.5. Selection of soil springs shall be based on the following:

1. Effect of the large difference in up and down slope stiffnesses for wharf type structures
2. Effect of upper and lower bound soil parameters, especially for t-z curves used to model batter pile behavior

A separate analysis that captures the demand (Section 3104F.2.3.2) on the piles due to permanent ground deformations, at embankments only, shall be performed.

If a simplified methodology is followed, the piles need to be checked for the following load combinations:

$$1.0E_{inertial}$$

$$1.0H_d + 0.25E_{inertial}$$

WHERE:

$E_{inertial}$ = Inertial seismic load
 H_d = Foundation deformation load

3104F.2.3.2 Nonlinear Static Demand Procedure. A nonlinear static procedure shall be used to determine the displacement demand for all concrete and steel structures, with the exception of irregular configurations with high or moderate seismic risk classifications. The following subsections describe the procedure of reference [4.1]; an alternate procedure is presented in ATC 40 [4.2]. A linear modal procedure is required for irregular structures with high or moderate seismic risk classifications, and may be used for all other classifications in lieu of the nonlinear static procedure.

3104F.2.3.2.1 Lateral Stiffness. The lateral stiffness, k , is calculated from the force-displacement relation as the total base shear, V_y , corresponding to the yield displacement of the structure Δ_y . Δ_y is the displacement at first yield in the pile/deck connection reinforcement.

3104F.2.3.2.2 Structural Period. The fundamental period, T , of the structure in the direction under consideration shall be calculated as follows:

$$T = 2\pi \sqrt{\frac{m}{k}} \quad (4-1)$$

WHERE:

m = mass of structure in kips/g
 k = stiffness in direction under consideration in kips/ft
 g = gravity, 32 ft/sec² (9.8 meters/sec²)

3104F.2.3.2.3 Target Displacement Demand. The target displacement demand of the structure, Δ_d , can be calculated by multiplying the spectral response acceleration, S_A , corresponding to the period, T , by $T^2/4\pi^2$.

$$\Delta_d = S_A \frac{T^2}{4\pi^2} \quad (4-2)$$

If $T < T_o$, where T_o is the period corresponding to the peak of the acceleration response spectrum, a refined analysis (see Section 3104F.2.3.2.5) shall be used to calculate the displacement demand. Multidirectional excitation shall be addressed per Section 3104F.4.2.

3104F.2.3.2.4 Damping. The displacement demand established in Section 3104F.2.3.2.3 is based on 5 percent damping. Higher damping values obtained from a refined analysis may be used to calculate the displacement demand.

3104F.2.3.2.5 Refined Analyses. Refined displacement demand analyses may be calculated as per Chapters 4 and 5 of [4.1] and is briefly summarized below.

1. Determine Δ_d , from Section 3104F.2.3.2.3.
2. From the nonlinear pushover analysis, determine the structural yield displacement Δ_y .
3. The ductility level, μ_Δ , is found from Δ_d/Δ_y . Use the appropriate relationship between ductility and damping, for the component undergoing inelastic deformation, to estimate the effective structural damping, ξ_{eff} . In lieu of more detailed analysis, the relationship shown in Figure 31F-4-3 or equation (4-3) may be used for concrete and steel piles connected to the deck through dowels embedded in the concrete.

$$\xi_{eff} = 0.05 + \frac{1}{\pi} \left(1 - \frac{1-r}{\sqrt{\mu_\Delta}} - r\sqrt{\mu_\Delta} \right) \quad (4-3)$$

WHERE:

r = ratio of second slope over elastic slope (see Figure 31F-4-5)

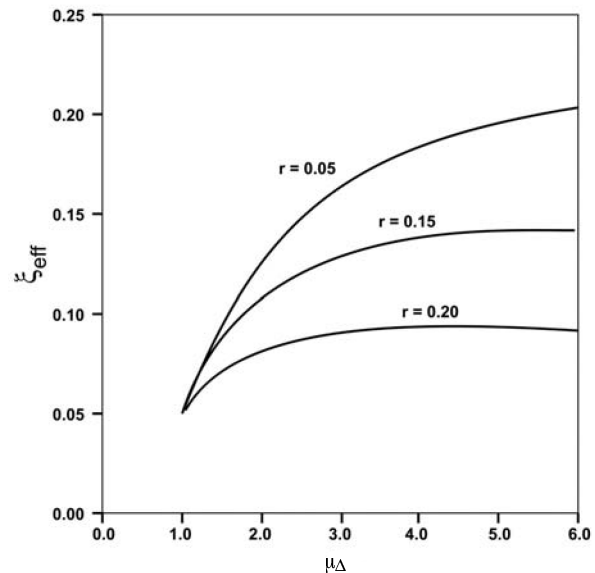

FIGURE 31F-4-3—RELATION BETWEEN DUCTILITY, μ_Δ , AND EFFECTIVE DAMPING, ξ_{eff} [4.1]

4. From the acceleration response spectra, create elastic displacement spectra, S_D , using equation (4-4) for various levels of damping.

$$S_D = \frac{T^2}{4\pi^2} S_A \quad (4-4)$$

5. Using the curve applicable to the effective structural damping, ξ , find the effective period, T_d (see Figure 31F-4-4).
6. In order to convert from a design displacement response spectra to another spectra for a different damping level, the adjustment factors in Section 3103F.4.2.9 shall be used.

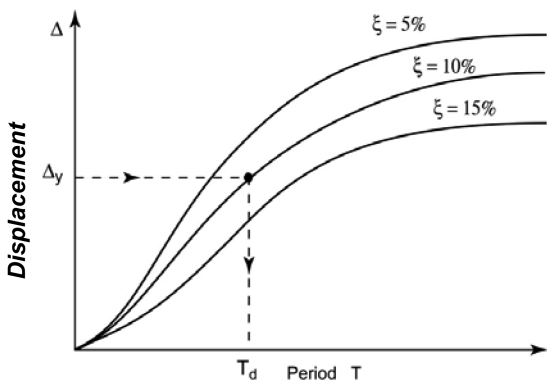

FIGURE 31F-4-4—DESIGN DISPLACEMENT RESPONSE SPECTRA

7. The effective stiffness k_e , can then be found from:

$$k_e = \frac{4\pi^2 M}{T_d^2} \quad (4-5)$$

WHERE:

M = mass of deck considered in the analysis.

T_d = effective structural period

8. The required strength F_u , can now be estimated by:

$$F_u = k_e \Delta_d \quad (4-6)$$

9. F_u and Δ_d can be plotted on the force-displacement curve established by the pushover analysis. Since this is an iterative process, the intersection of F_u and Δ_d most likely will not fall on the force-displacement curve and a second iteration will be required. An adjusted value of Δ_d , taken as the intersection between the force-displacement curve and a line between the origin and F_u and Δ_d , can be used to find μ_{Δ} .

10. Repeat the process until a satisfactory solution is obtained (see Figure 31F-4-5).

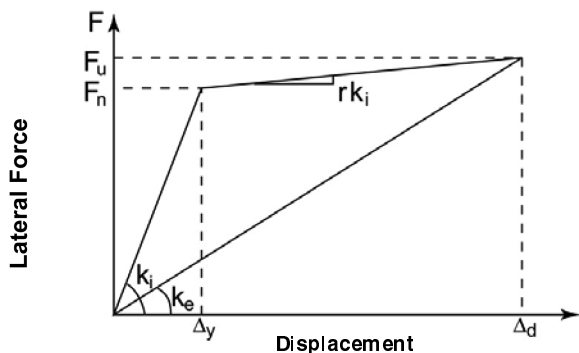

FIGURE 31F-4-5—EFFECTIVE STIFFNESS, k_e [4.1]

3104F.2.3.3 Linear Modal Demand Procedure. For irregular concrete/steel structures with moderate or high risk classifications, a linear analysis is required to predict the global displacement demands. A 3-D linear elastic response analysis shall be used, with effective moment of inertia applied to components to establish lateral displacement demands.

Sufficient modes shall be included in the analysis such that 90 percent of the participating mass is captured in each of the princi-

pal horizontal directions for the structure. For modal combinations, the Complete Quadratic Combination rule shall be used. Multidirectional excitation shall be accounted for in accordance with Section 3104F.4.2.

The lateral stiffness of the linear elastic response model shall be based on the initial stiffness of the nonlinear pushover curve as shown in Figure 31F-4-6 (also see Section 3106F.5.1). The p - y springs shall be adjusted based on the secant method approach. Most of the p - y springs will typically be based on their initial stiffness; no iteration is required.

If the fundamental period in the direction under consideration is less than T_0 , as defined in Section 3104F.2.3.2.3, then the displacement demand shall be amplified as specified in Section 3104F.2.3.2.5.

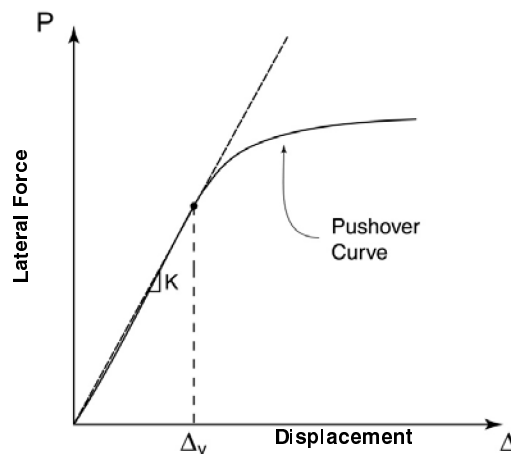

FIGURE 31F-4-6—STIFFNESS FOR LINEAR MODAL ANALYSIS

3104F.2.3.4 Nonlinear Dynamic Analysis. Nonlinear dynamic time history analysis is optional, and if performed, a peer review is required (see Section 3101F.6.1). Multiple acceleration records shall be used, as explained in Section 3103F.4.2.10. The following assumptions may be made:

1. Equivalent “super piles” can represent groups of piles.
2. If the deck has sufficient rigidity (both in-plane and out-of-plane) to justify its approximation as a rigid element, a 2-D plan simulation may be adequate.

A time-history analysis should always be compared with a simplified approach to ensure that results are reasonable. Displacements calculated from the nonlinear time history analyses may be used directly in design, but shall not be less than 80 percent of the values obtained from Section 3104F.2.3.2.

3104F.2.3.5 Alternative Procedures. Alternative lateral-force procedures using rational analyses based on well-established principles of mechanics may be used in lieu of those prescribed in these provisions. As per Section 3101F.6.1, peer review is required.

3104F.3 New MOTs. The analysis and design requirements described in Section 3104F.2 shall also apply to new MOTs. Additional requirements are as follows:

1. Site-specific response spectra analysis (see Section 3103F.4.2.3).
2. Soil parameters based on site-specific and new borings (see Section 3106F.2.2).

3104F.4 General Analysis and Design Requirements.

3104F.4.1 Load Combinations. Earthquake loads shall be used in the load combinations described in Section 3103F.8.

3104F.4.2 Combination of Orthogonal Effects. The design displacement demand, Δ_d , shall be calculated by combining the longitudinal, Δ_x , and transverse, Δ_y , displacements in the horizontal plane (Figure 31F-4-7):

$$\Delta_d = \sqrt{\Delta_x^2 + \Delta_y^2} \quad (4-7)$$

WHERE:

$$\Delta_x = \Delta_{yx} + 0.3\Delta_{xx} \quad (4-8)$$

and
$$\Delta_y = 0.3\Delta_{yx} + \Delta_{yy} \quad (4-9)$$

or

and
$$\Delta_y = \Delta_{yx} + 0.3\Delta_{yy} \quad (4-10)$$

$$\Delta_x = 0.3\Delta_{yx} + \Delta_{xx} \quad (4-11)$$

whichever results in the greater design displacement demand.

In lieu of combining the displacement demands as presented above, the design displacement demand for marginal wharf type MOTs may be calculated as:

$$\Delta_d = \Delta_y \sqrt{1 + (0.3(1 + 20e/L_l))^2} \quad (4-12)$$

WHERE:

Δ_y = transverse displacement demand

e = eccentricity between center of mass and center of rigidity

L_l = longitudinal length between wharf expansion

This equation is only valid for wharf aspect ratios (length/breadth) greater than 3.

3104F.4.3 P- Δ Effects. The P- Δ effect (i.e., the additional moment induced by the total vertical load multiplied by the lateral deck deflection) shall be considered unless the following relationship is satisfied (see Figure 31F-4-8):

$$\frac{V}{W} \geq 4 \frac{\Delta_d}{H} \quad (4-13)$$

WHERE:

V = base shear strength of the structure obtained from a plastic analysis

W = dead load of the frame

Δ_d = displacement demand

H = distance from the location of maximum in-ground moment to center of gravity of the deck

For wharf structures where the lateral displacement is limited by almost fully embedded piles, P- Δ effects may be ignored; however, the individual stability of the piles shall be checked in accordance with Section 3107F.2.5.2.

If the landside batter piles are allowed to fail in a Level 2 evaluation, the remaining portion of the wharf shall be checked for P- Δ effects.

3104F.4.4 Expansion Joints. The effect of expansion joints shall be considered in the seismic analysis.

3104F.4.5 Shear Key Forces. Shear force across shear keys connecting adjacent wharf segments, V_{sk} , (approximate upper bound to the shear key force [4.3]) shall be calculated as follows:

$$V_{sk} = 1.5(e/L_l)V_{\Delta T} \quad (4-14)$$

WHERE:

$V_{\Delta T}$ = total segment lateral force found from a push-over analysis

L_l = segment length

e = eccentricity between the center of rigidity and the center of mass

3104F.4.6 Connections. For an existing wharf, the deteriorated conditions at the junction between the pile top and pile cap shall be considered in evaluating the moment capacity. Connection detail between the vertical pile and pile cap shall be evaluated to determine whether full or partial moment capacity can be developed under seismic action.

For new MOTs, the connection details shall develop the full moment capacities.

The modeling shall simulate the actual moment capacity (full or partial) of the joint in accordance with Section 3107F.2.7.

3104F.4.7 Batter Piles. Batter piles primarily respond to earthquakes by developing large axial compression or tension forces. Bending moments are generally of secondary importance. Failure in compression may be dictated by the deck-pile connection (most common type), material compression, buckling, or by excessive local shear in deck members adjacent to the batter pile. Failure in tension may be dictated by connection strength or by pile pull out. (p. 3-83 of [4.3]).

When the controlling failure scenario is reached and the batter pile fails, the computer model shall be adjusted to consist of only the vertical pile acting either as a full or partial moment frame based on the connection details between the pile top and pile cap. The remaining displacement capacity, involving vertical piles, before the secondary failure stage develops, shall then be established (see Section 3107F.2.8).

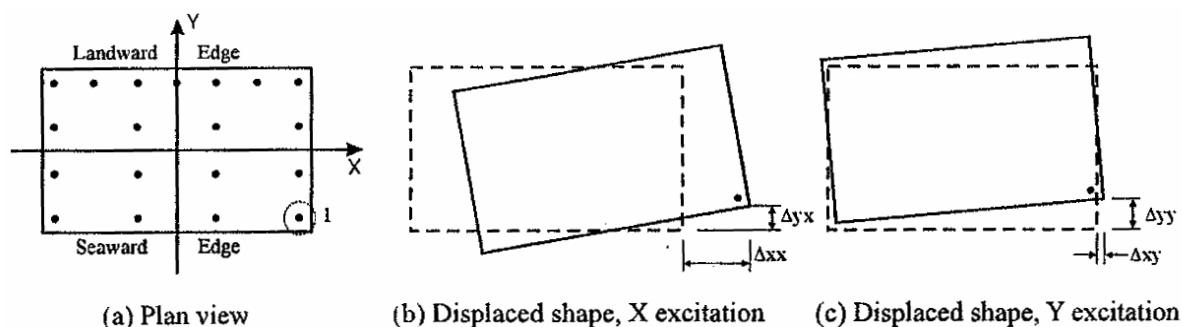

FIGURE 31F-4-7—PLAN VIEW OF WHARF SEGMENT UNDER X AND Y SEISMIC EXCITATIONS [4.3]

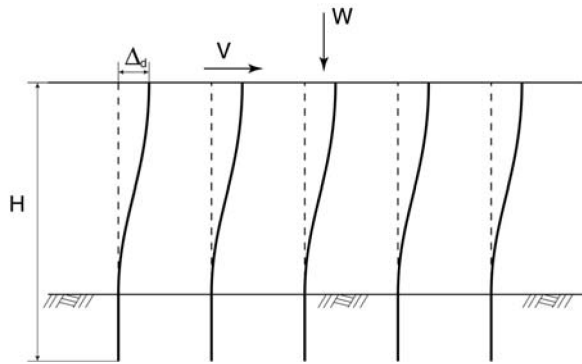

FIGURE 31F-4-8—P-Δ EFFECT

Axial p - z curves shall be modeled. In compression, displacement capacity should consider the effect of the reduction in pile modulus of elasticity at high loads and the increase in effective length for friction piles. This procedure allows the pile to deform axially before reaching ultimate loads, thereby increasing the displacement ductility [4.3].

Horizontal nonlinear p - y springs are only applied to batter piles with significant embedment, such as for landside batter piles in a wharf structure. Moment fixity can be assumed for batter piles that extend well above the ground such as waterside batter piles in a wharf structure or batter piles in a pier type structure.

3104F.5 Nonstructural Components. Nonstructural components including, but not limited to pipelines, loading arms, raised platforms, control rooms and vapor control equipment may affect the global structural response. In such cases, the seismic characteristics (mass and/or stiffness) of the nonstructural components shall be considered in the structural analysis.

3104F.5.1 Mass Contribution. The weight of permanently attached nonstructural components shall be included in the dead load of the structure, per Section 3103F.2. An exception is an MOT pipeline that is allowed to slide between anchor points and hence the pipeline response is typically out of phase with the structural response. Thus, the pipeline may be subjected to a different acceleration than the substructure, even if the pipeline cannot slide between anchor points. In such cases, the pipeline mass shall not be included directly in the seismic mass of the structure.

3104F.5.2 Seismic Loads. In general, for nonstructural components, the evaluation procedures of Section 3110F.8 are adequate.

For pipelines, the seismic analysis shall be performed in accordance with Section 3109F.3, in lieu of Section 3110F.8. If an analysis has been performed and support reactions are available, they may be used to determine the forces on the support structure.

A pipeline segment under consideration shall extend between two adjacent anchor points. A simplified pipeline analysis may be used when the relative displacement demands of anchor points are considered. As an option, a full nonlinear time-history analysis can be used to capture the nonlinear interaction between the structure and the pipeline.

3104F.6 Nonstructural Critical Systems Assessment. A seismic assessment of the survivability and continued operation during a Level 2 earthquake (see Table 31F-4-2) shall be performed for critical systems such as fire protection, emergency shutdown and electrical power systems. The assessment shall consider the ade-

quacy and condition of anchorage, flexibility and seismically-induced interaction. The results shall be included in the Audit.

3104F.7 Symbols.

- e = Eccentricity between center of mass and center of rigidity
- $E_{inertial}$ = Inertial seismic load
- F_u = Required strength at maximum response
- H = Distance from maximum in-ground moment to center of gravity of the deck
- H_d = Foundation deformation load
- k = Stiffness in direction under consideration in k/ft
- k_e = Effective stiffness
- L_l = Longitudinal length between wharf expansion joints
- m = Mass of structure in kips/g
- M = Mass of deck considered in the analysis
- r = Ratio of second slope over elastic slope
- S_A = Spectral response acceleration, at T
- S_D = Displacement response spectrum, at T
- S_{ap} = Spectral response acceleration of pipeline segment under consideration
- T = Fundamental period of structure
- T_d = Effective structural period
- V = Base shear strength of the structure obtained from a plastic analysis
- V_y = total base shear
- $V_{\Delta T}$ = total segment lateral force
- V_{sk} = Shear force across shear keys
- W = Dead load of the frame
- W_p = Weight of pipeline segment under consideration
- Δ_d = Design displacement demand
- Δ_x = Longitudinal displacement demand
- Δ_{xx} = X displacement under X direction excitation
- Δ_{xy} = X displacement under Y direction excitation
- Δ_y = Transverse displacement demand
- Δ_{yx} = Y displacement under X direction excitation
- Δ_{yy} = Y displacement under Y direction excitation
- μ_{Δ} = Ductility level
- ξ_{eff} or ξ = Effective structural damping

3104F.8 References.

- [4.1] Priestley, M.J.N., Sieble, F., Calvi, G.M., 1996, "Seismic Design and Retrofit of Bridges," John Wiley & Sons, Inc., New York, USA.
- [4.2] Applied Technology Council, ATC-40, 1996, "Seismic Evaluation and Retrofit of Concrete Buildings", Vols. 1 and 2, Redwood City, CA.
- [4.3] Ferritto, J., Dickenson, S., Priestley N., Werner, S., Taylor, C., Burke D., Seelig W., and Kelly, S., 1999, "Seismic Criteria for California Marine Oil Terminals," Vol. 1 and Vol. 2, Technical Report TR-2103-SHR, Naval Facilities Engineering Service Center, Port Hueneme, CA.

Authority: Sections 8755 and 8757, Public Resources Code.
Reference: Sections 8750, 8751, 8755 and 8757, Public Resources Code.

Division 5

SECTION 3105F — MOORING AND BERTHING ANALYSIS AND DESIGN

3105F.1 General.

3105F.1.1 Purpose. This Section establishes minimum standards for safe mooring and berthing of vessels at MOTs.

3105F.1.2 Applicability. This Section applies to onshore MOTs; Figure 31F-5-1 shows typical pier and wharf configurations.

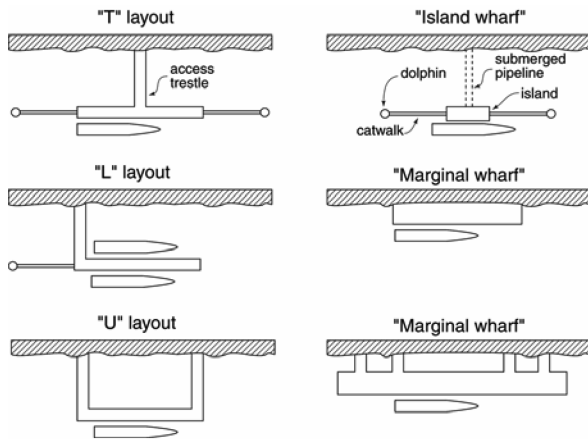

FIGURE 31F-5-1—TYPICAL PIER AND WHARF CONFIGURATIONS

3105F.1.3 Mooring/Berthing Risk Classification. Each MOT shall be assigned a mooring/berthing risk classification of high, medium or low, as determined from Table 31F-5-1, based on the following site-specific parameters:

1. Wind
2. Current
3. Hydrodynamic effects of passing vessels
4. Change in vessel draft

Exceedance of any of the defined condition thresholds in Table 31F-5-1 places the MOT in the appropriate mooring/berthing risk classification.

The maximum wind, V_w , (corrected for duration, height and over water) and maximum current, V_c , shall be obtained (see Section 3103F.5).

In order to determine if there are significant potential passing vessel effects on moored vessels at an MOT, see Section 3105F.3.2.

The range of vessel draft shall be based on the local tidal variation and the operational limits of the vessels berthing at the MOT.

Multiple berth MOTs shall use the same conditions for each berth unless it can be demonstrated that there are significant differences.

MOTs with high mooring/berthing risk classifications (Table 31F-5-1) shall have the following equipment in operation: an anemometer (N/E), a current meter (N/E) (may be omitted if safety factor according to Section 3103F.5.3.1 is applied to current) and remote reading tension load devices (N).

3105F.1.4 New MOTs. Quick release hooks are required at all new MOTs, except for spring line fittings. Quick release hooks

shall be sized, within normal allowable stresses, for the safe working load of the largest size mooring line and configuration. To avoid accidental release, the freeing mechanism shall be activated by a two-step process. Quick release hooks shall be insulated electrically from the mooring structure, and should be supported so as not to contact the deck.

3105F.1.5 Analysis and Design of Mooring Components. The existing condition of the MOT shall be used in the mooring analysis (see Section 3102F). Structural characteristics of the MOT, including type and configuration of mooring fittings such as bollards, bits, hooks and capstans and material properties and condition, shall be determined in accordance with Sections 3107F.4 and 3103F.10.

The analysis and design of mooring components shall be based on the loading combinations and safety factors defined in Sections 3103F.8 through 3103F.10, and in accordance with ACI 318 [5.1], AISC-LRFD [5.2] and ANSI/AF&PA NDS-1997 [5.3], as applicable.

3105F.2 Mooring Analyses. A mooring analysis shall be performed for each berthing system, to justify the safe berthing of the various deadweight capacities of vessels expected at the MOT. The forces acting on a moored vessel shall be determined in accordance with Section 3103F.5. Mooring line and breasting load combinations shall be in accordance with Section 3103F.8.

Two procedures, manual and numerical are available for performing mooring analyses. These procedures shall conform to either the OCIMF documents, "Mooring Equipment Guidelines" [5.4] and "Prediction of Wind and Current Loads on VLCCs" [5.5] or the Department of Defense "Mooring Design" document [5.6]. The manual procedure (subsection 3105F.2.1) may be used for barges.

A new mooring assessment shall be performed when conditions change, such as any modification in the mooring configuration, vessel size or new information indicating greater wind, current or other environmental loads.

In general, vessels shall remain in contact with the breasting or fendering system. Vessel motion (sway) of up to 2 feet off the breasting structure may be allowed under the most severe environmental loads, unless greater movement can be justified by an appropriate mooring analysis that accounts for potential dynamic effects. The allowable movement shall be consistent with mooring analysis results, indicating that forces in the mooring lines and their supports are within the allowable safety factors. Also, a check shall be made as to whether the movement is within the limitations of the cargo transfer equipment.

The most severe combination of the environmental loads has to be identified for each mooring component. At a minimum, the following conditions shall be considered:

1. Two current directions (maximum ebb and flood; See Section 3103F.5.3)
2. Two tide levels (highest high and lowest low)
3. Two vessel loading conditions (ballast and maximum draft at the terminal)
4. Eight wind directions (45 degree increments)

3105F.2.1 Manual Procedure. For MOTs classified as Low risk (Table 31F-5-1), simplified calculations may be used to determine the mooring forces, except if any of the following conditions exist (Figures 31F-5-2 and 31F-5-3, below).

TABLE 31F-5-1
MOORING/BERTHING RISK CLASSIFICATION

RISK CLASSIFICATION	WIND, (V_W) (knots)	CURRENT, (V_C) (knots)	PASSING VESSEL EFFECTS	CHANGE IN DRAFT (ft)
High	> 50	> 1.5	Yes	> 8
Medium	30 to 50	1.0 to 1.5	No	6 to 8
Low	< 30	< 1.0	No	< 6

1. Mooring layout is significantly asymmetrical
2. Horizontal mooring line angles (α) on bow and stern exceed 45 degrees
3. Horizontal breast mooring line angles exceed 15 normal to the hull
4. Horizontal spring mooring line angles exceed 10 degrees from a line parallel to the hull
5. Vertical mooring line angles (θ) exceed 25 degrees
6. Mooring lines for lateral loads not grouped at bow and stern

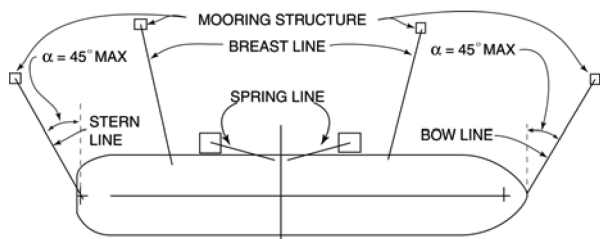

FIGURE 31F-5-2—HORIZONTAL LINE ANGLES [5.4]

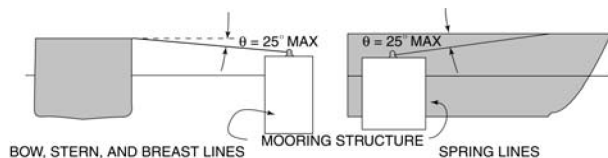

FIGURE 31F-5-3—VERTICAL LINE ANGLES [5.4]

When the forces have been determined and the distance between the bow and stern mooring points is known, the yaw moment can be resolved into lateral loads at the bow and stern. The total environmental loads on a moored vessel are comprised of the lateral load at the vessel bow, the lateral load at the vessel stern and the longitudinal load. Line pretension loads must be added.

Four load cases shall be considered:

1. Entire load is taken by mooring lines
2. Entire load is taken by breasting structures
3. Load is taken by combination of mooring lines and breasting structures
4. Longitudinal load is taken only by spring lines

3105F.2.2 Numerical Procedure. A numerical procedure is required to obtain mooring forces for MOTs classified as Medium or High (See Table 31F-5-1) and for those that do not satisfy the requirements for using simplified calculations. Computer program(s) shall be based on mooring analysis procedures that consider the characteristics of the mooring system, calculate the environmental loads and provide resulting mooring line forces and vessel motions (surge and sway).

3105F.3 Wave, Passing Vessel, Seiche and Tsunami.

3105F.3.1 Wind Waves. MOTs are generally located in sheltered waters such that typical wind waves can be assumed not to affect the moored vessel if the significant wave period, T_s , is less than 4 seconds. However, if the period is equal to or greater than 4 seconds, then a simplified dynamic analysis (See Section 3103F.5.4) is required. The wave period shall be established based on a 1-year significant wave height, H_s . For MOTs within a harbor basin, the wave period shall be based on the locally generated waves with relatively short fetch.

3105F.3.2 Passing Vessels. These forces generated by passing vessels are due to pressure gradients associated with the flow pattern. These pressure gradients cause the moored vessel to sway, surge, and yaw, thus imposing forces on the mooring lines.

Passing vessel analysis shall be conducted when all of the following conditions exist (See Figure 31F-5-4):

1. Passing vessel size is greater than 25,000 dwt.
2. Distance L is 500 feet or less
3. Vessel speed V is greater than V_{crit}

WHERE:

$$V_{crit} = 1.5 + \frac{L - 2B}{500 - 2B} 4.5 \text{ (knots)} \quad (5-1)$$

EXCEPTION: If $L \leq 2B$, passing vessel loads shall be considered.

L and B are shown in Figure 31F-5-4, in units of feet. V is defined as the speed of vessel over land minus the current velocity, when traveling with the current, or the speed of vessel over land plus the current velocity, when traveling against the current.

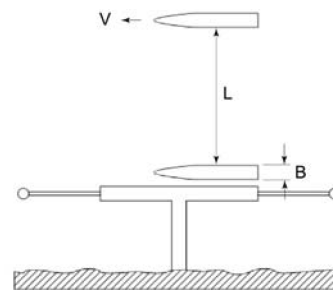

FIGURE 31F-5-4—PASSING VESSEL

When such conditions (1, 2 and 3 above) exist, the surge and sway forces and the yaw moment acting on the moored vessel shall, as a minimum, be established in accordance with Section 3103F.5.5. If the demands from such evaluation are greater than 75 percent of the mooring system capacity (breaking strength of mooring lines), then a more sophisticated dynamic analysis is required.

For MOTs located in ports, the passing distance, L , may be established based on channel width and vessel traffic patterns. The guidelines established in the Navy's "Harbors Design Manual," Figure 27 [5.7] for interior channels may be used. The "vertical bank" in Figure 27 of [5.7] shall be replaced by the side of the moored vessel when establishing the distance, " L ".

For MOTs, not located within a port, the distance, "L", must be determined from observed traffic patterns.

The following passing vessel positions shall be investigated:

1. Passing vessel is centered on the moored ship. This position produces maximum sway force.
2. The midship of the passing vessel is fore or aft of the centerline of the moored ship by a distance of 0.40 times the length of the moored ship. This position is assumed to produce maximum surge force and yaw moment at the same time.

The mooring loads due to a passing vessel shall be added to the mooring loads due to wind and current.

3105F.3.3 Seiche. A seiche analysis is required for existing MOTs located within a harbor basin and which have historically experienced seiche. A seiche analysis is required for new MOTs inside a harbor basin prone to penetration of ocean waves.

The standing wave system or seiche is characterized by a series of "nodes" and "antinodes". Seiche typically has wave periods ranging from 20 seconds up to several hours, with wave heights in the range of 0.1 to 0.4 ft [5.7].

The following procedure may be used, as a minimum, in evaluating the effects of seiche within a harbor basin. In more complex cases where the assumptions below are not applicable, dynamic methods are required.

1. Calculate the natural period of oscillation of the basin. The basin may be idealized as rectangular, closed or open at the seaward end. Use the formula provided (Eqn. 2-1, page 26.1-40) in the Navy's "Harbor Design Manual" [5.7] to calculate the wave period and length for different modes. The first three modes shall be considered in the analysis.
2. Determine the location of the moored ship with respect to the antinode and node of the first three modes to determine the possibility of resonance.
3. Determine the natural period of the vessel and mooring system. The calculation shall be based on the total mass of the system and the stiffness of the mooring lines in surge. The surge motion of the moored vessel is estimated by analyzing the vessel motion as a harmonically forced linear single degree of freedom spring mass system. Methods outlined in a paper by F.A. Kilner [5.8] can be used to calculate the vessel motion.
4. Vessels are generally berthed parallel to the channel; therefore, only longitudinal (surge) motions shall be considered, with the associated mooring loads in the spring lines. The loads on the mooring lines (spring lines) are then determined from the computed vessel motion and the stiffness of those mooring lines.

3105F.3.4 Tsunami. Run-up and current velocity shall be considered in the tsunami assessment. Table 31F-3-8 provides run-up values for the San Francisco Bay area, Los Angeles/Long Beach Harbors and Port Hueneme.

3105F.4 Berthing Analysis and Design. In general and for new MOTs, the fender system alone shall be designed to absorb the berthing energy. For existing MOTs, the berthing analysis may include the fender and structure.

The analysis and design of berthing components shall be based on the loading combinations and safety factors defined in Sections 3103F.8 and 3103F.9 and in accordance with ACI 318 [5.1], AISC-LRFD [5.2], and ANSI/AF&PA NDS-1997 [5.3], as applicable.

3105F.4.1 Berthing Energy Demand. The kinetic berthing energy demand shall be determined in accordance with Section 3103F.6.

3105F.4.2 Berthing Energy Capacity. For existing MOTs, the berthing energy capacity shall be calculated as the area under the force-deflection curve for the combined structure and fender system as indicated in Figure 31F-5-5. Fender piles may be included in the lateral analysis to establish the total force-deflection curve for the berthing system. Load-deflection curves for other fender types shall be obtained from manufacturer's data. The condition of fenders shall be taken into account when performing the analysis.

When batter piles are present, the fender system typically absorbs most of the berthing energy. This can be established by comparing the force-deflection curves for the fender system and batter piles. In this case only the fender system energy absorption shall be considered.

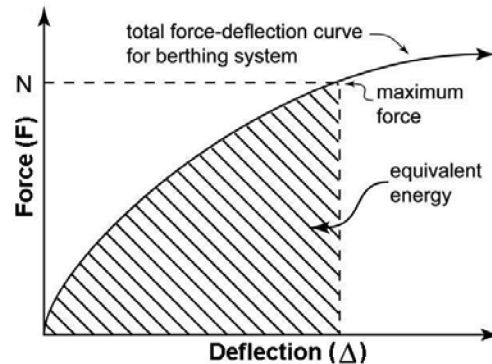

FIGURE 31F-5-5—BERTHING ENERGY CAPACITY

3105F.4.3 Tanker Contact Length.

3105F.4.3.1 Continuous Fender System. A continuous fender system consists of fender piles, chocks, wales, and rubber or spring fender units.

The contact length of a ship during berthing depends on the spacing of the fender piles and fender units, and the connection details of the chocks and wales to the fender piles.

The contact length, L_c , can be approximated by the chord formed by the curvature of the bow and the berthing angle as shown in Equation 5-2 below.

$$L_c = 2r \sin \alpha \quad (5-2)$$

WHERE:

- L_c = contact length
- r = Bow radius
- α = Berthing Angle

In lieu of detailed analysis to determine the contact length, Table 31F-5-2 may be used. The contact length for a vessel within the range listed in the table can be obtained by interpolation.

TABLE 31F-5-2
CONTACT LENGTH

VESSEL SIZE (dwt)	CONTACT LENGTH
330	25 ft
1,000 to 2,500	35 ft
5,000 to 26,000	40 ft
35,000 to 50,000	50 ft
65,000	60 ft
100,000 to 125,000	70 ft

3105F.4.3.2 Discrete Fender System. For discrete fender systems (i.e., not continuous), one fender unit or breasting dolphin shall be able to absorb the entire berthing energy.

3105F.4.4 Longitudinal and Vertical Berthing Forces. The longitudinal and vertical components of the horizontal berthing force shall be calculated using appropriate coefficients of friction between the vessel and the fender. In lieu of as-built data, the values in Table 31F-5-3 may be used for typical fender/vessel materials:

**TABLE 31F-5-3
COEFFICIENT OF FRICTION**

CONTACT MATERIALS	FRICTION COEFFICIENT
Timber to Steel	0.4 to 0.6
Urethane to Steel	0.4 to 0.6
Steel to Steel	0.25
Rubber to Steel	0.6 to 0.7
UHMW* to Steel	0.1 to 0.2

*Ultra-high molecular weight plastic rubbing strips.

Longitudinal and vertical forces shall be determined by:

$$F = \mu N \quad (5-3)$$

WHERE:

- F = longitudinal or vertical component of horizontal berthing force
- μ = coefficient of friction of contact materials
- N = maximum horizontal berthing force (normal to fender)

3105F.4.5 Design and Selection of New Fender Systems. For guidelines on new fender designs, refer to the Navy's "Piers and Wharves" handbook [5.9] and the PIANC Guidelines for the Design of Fenders Systems: 2002 [5.10].

3105F.5 Layout of New MOTs. The number and spacing of independent mooring dolphins and breasting dolphins depends on the DWT and length overall (LOA) of vessels to be accommodated.

Breasting dolphins shall be positioned adjacent to the parallel body of the vessel when berthed. A minimum of two breasting dolphins shall be provided. The spacing of breasting dolphins shall be adequate for all sizes of vessels that may berth at the MOT.

Mooring dolphins shall be set back from the berthing line (fender line) for a distance between 115 ft and 165 ft, so that longer bow, stern and breast lines can be deployed.

For a preliminary layout, the guidelines in the British Standards, Part 4, Section 2 [5.11], may be used in conjunction with the guidelines below.

1. If four breasting dolphins are provided, the spacing between exterior breasting dolphins shall be between 0.3 and 0.4 LOA of the maximum sized vessel expected to call at the MOT. The spacing between interior breasting dolphins shall be approximately 0.3 to 0.4 LOA of the minimum sized vessel expected to call at the MOT.
2. If only two breasting dolphins are provided, the spacing between the dolphins shall be the smaller (0.3 LOA) of the guidelines specified above.
3. If bow and stern lines are used for mooring, the spacing between exterior mooring dolphins shall be 1.35 times the LOA of the maximum sized vessel expected to call at the MOT.
4. The spacing between interior mooring dolphins shall be 0.8 times the LOA of the maximum sized vessel expected to call at the MOT.

The final layout of the mooring and breasting dolphins shall be determined based on the results of the mooring analysis that provides optimal mooring line and breasting forces for the range of

vessels to be accommodated. The breasting force under the mooring condition shall not exceed the maximum fender reaction of the fender unit when it is being compressed at the manufacturers rated deflection.

3105F.6 Symbols.

- α = Berthing Angle. It also indicates the angle of horizontal mooring lines, see Fig 5-2.
- Δ = Deflection
- θ = Vertical mooring line angles
- B = Beam of vessel
- F = Longitudinal or vertical component of horizontal normal berthing force
- L = Distance between passing and moored vessels
- L_c = Contact length
- N = Maximum horizontal berthing force
- r = Bow radius
- μ = Coefficient of friction of contact materials
- V = Ground speed (knots)
- V_c = Maximum current (knots).
- V_{crit} = Ground speed (knots) above which passing loads must be considered
- V_w = Maximum wind speed (knots)

3105F.7 References.

- [5.1] American Concrete Institute, ACI 318-02, 2002, "Building Code Requirements for Structural Concrete (318-02) and Commentary (318R-02)," Farmington Hills, Michigan.
- [5.2] American Institute of Steel Construction (AISC), 2001, "Manual of Steel Construction, Load and Resistance Factor Design (LRFD)," 3rd Ed., Chicago, IL.
- [5.3] American Forest & Paper Association, 1999, "ASD Manual - National Design Specification for Wood Construction," ANSI/AF&PA NDS-1997, Washington, D.C.
- [5.4] Oil Companies International Marine Forum (OCIMF), 1997, "Mooring Equipment Guidelines", 2nd Ed., London, England.
- [5.5] Oil Companies International Marine Forum (OCIMF), 1977, "Prediction of Wind and Current Loads on VLCCs," London, England.
- [5.6] Department of Defense, 1 July 1999, "Mooring Design," Handbook, MIL-HDBK-1026/4A, Alexandria, VA, USA.
- [5.7] Department of the Navy, Dec. 1984, "Harbors Design Manual," NAVFAC DM-26.1, Alexandria, VA, USA.
- [5.8] Kilner F.A., 1961, "Model Tests on the Motion of Moored Ships Placed on Long Waves." Proceedings of 7th Conference on Coastal Engineering, August 1960, The Hague, Netherlands, published by the Council on Wave Research - The Engineering Foundation.
- [5.9] Department of the Navy, 30 October 1987, "Piers and Wharves," Military Handbook, MIL-HDBK-1025/1, Alexandria, VA, USA.
- [5.10] Permanent International Association of Navigation Congresses (PIANC), 2002, "Guidelines for the Design of Fender Systems: 2002," Brussels.
- [5.11] British Standards Institution, 1994, "British Standard Code of Practice for Maritime Structures — Part 4.

L
L
L
L
L
L

*Code of Practice for Design of Fendering and Mooring
Systems”, BS6349, London, England.*
Authority: Sections 8755 and 8757, Public Resources Code.

*Reference: Sections 8750, 8751, 8755 and 8757, Public Re-
sources Code.*

C
A
C

L
L
L

Division 6

SECTION 3106F — GEOTECHNICAL HAZARDS AND FOUNDATIONS

3106F.1 General.

3106F.1.1 Purpose. This section provides minimum standards for analyses and evaluation of geotechnical hazards and foundations.

3106F.1.2 Applicability. The requirements provided herein apply to all new and existing MOTs.

3106F.1.3 Seismic Loading. The seismic loading for geotechnical hazard assessment and foundation analyses is provided in Section 3103F.4.

3106F.2 Site Characterization.

3106F.2.1 Site Classes. Each MOT shall be assigned at least one site class, based on site-specific geotechnical information. Site Classes S_A , S_B , S_C , S_D , and S_E are defined in Table 31F-6-1 and Site Class S_F is defined as follows:

1. Soils vulnerable to significant potential loss of stiffness, strength, and/or volume under seismic loading, such as liquefiable soils, quick and highly sensitive clays, and collapsible weakly cemented soils.
2. Peats and/or highly organic clays, where the thickness of peat or highly organic clay exceeds 10 feet.
3. Very high plasticity clays with a plasticity index (PI) greater than 75, where depth of clay exceeds 25 feet.
4. Very thick soft/medium stiff clays, where the depth of clay exceeds 120 feet.

3106F.2.2 Site-Specific Information. In general, geotechnical characterization shall be based on site-specific information. This information may be obtained from existing or new sources. However, if existing or nonsite specific information is used, the geotechnical engineer of record shall provide adequate justification for its use.

Site-specific investigations shall include, at a minimum, borings and/or cone penetration tests, soil classifications, configuration, foundation loading and an assessment of seismic hazards. The array (number and depths) of exploratory borings and cone penetration tests (CPT) will depend on the proposed or existing structures and site stratigraphy. The investigation or testing activities shall be completed following the procedures in Section 5 of SCEC [6.3]. CPT data may also be used by first converting to

standard penetration test (SPT) data, using an appropriate method, that reflects the effects of soil gradation. If geotechnical data other than SPT and CPT are used, an adequate explanation and rationale shall be provided.

Quantitative soil information is required to a depth of 100 feet below the mudline, for assigning a Site Class (see Table 31F-6-1). When data to a depth of 100 feet is unavailable, other information such as geologic considerations may be used to determine the Site Class.

3106F.3 Liquefaction. A liquefaction assessment shall address triggering and the resulting hazards, using residual shear strengths of liquefied soils.

3106F.3.1 Triggering Assessment. Liquefaction triggering shall be expressed in terms of the factor of safety (SF):

$$SF = CRR/CSR \quad (6-1)$$

WHERE:

CRR = Cyclic Resistance Ratio

CSR = The Cyclic Stress Ratio induced by Design Peak Ground Acceleration (DPGA) or other postulated shaking

The CRR shall be determined from Figure 7.1 in SCEC [6.3]. If available, both the SPT and CPT data can be used.

CSR shall be evaluated using the simplified procedure in Section 3106F.3.1.1 or site-specific response analysis procedures in Section 3106F.3.1.2.

Shaking-induced shear strength reductions in liquefiable materials are determined as follows:

1. $SF > 1.4$

Reductions of shear strength for the materials for postearthquake conditions may be neglected.

2. $1.0 < SF < 1.4$

A strength value intermediate to the material's initial strength and residual undrained shear strength should be selected based on the level of residual excess pore water pressure expected to be generated by the ground shaking (e.g., Figure 10 of Seed and Harder, [6.4]).

3. $SF \leq 1.0$

Reduction of the material shear strength to a residual undrained shear strength level shall be considered, as described in Section 3106F.3.2.

**TABLE 31F-6-1
SITE CLASSES**

SITE CLASS	SOIL PROFILE NAME/GENERIC DESCRIPTION	AVERAGE VALUES FOR TOP 100 FEET OF SOIL PROFILE		
		Shear Wave Velocity, V_s [ft/sec]	Standard Penetration Test [blows/ft]	Undrained Shear Strength, S_u [psf]
S_A	Hard Rock	>5,000	—	—
S_B	Rock	2,500 to 5,000	—	—
S_C	Very Stiff/Dense Soil and Soft Rock	1,200 to 2,500	>50	>2,000
S_D	Stiff/Dense Soil Profile	600 to 1,200	15 to 50	1,000 to 2,000
S_E	Soft/Loose Soil Profile	<600	<15	<1,000
S_F	Defined in Section 3106F.2.1			

Notes:

1. Site Class S_F shall require site-specific geotechnical information as discussed in Sections 3106F.2.2 and 3103F.4.

2. Site Class S_E also includes any soil profile with more than 10 feet of soft clay defined as a soil with a plasticity index, $PI > 20$, water content > 40 percent and $S_u < 500$ psf.

3. The plasticity index, PI , and the moisture content shall be determined in accordance with ASTM D4318 [6.1] and ASTM D2216 [6.2], respectively.

3106F.3.1.1 Simplified Procedure. The simplified procedure to evaluate liquefaction triggering shall follow Section 7 of SCEC [6.3]. Cyclic stress ratio (CSR) is used to define seismic loading, in terms of the Design Peak Ground Acceleration (DPGA) and Design Earthquake Magnitude (DEM). DPGA and DEM are addressed in Section 3103F.4.2. CSR is defined as:

$$CSR = 0.65 \left(\frac{DPGA}{g} \right) \left(\frac{\sigma_v}{\sigma'_v} \right) \left(\frac{r_d}{r_{MSF}} \right) \quad (6-2)$$

WHERE:

- g = gravitational constant
- σ_v = the vertical total stress
- σ'_v = the vertical effective stress
- r_d = a stress reduction factor
- r_{MSF} = the magnitude scaling factor

For values of r_{MSF} and r_d , see SCEC [6.3] Figures 7.2 and 7.3, respectively. To evaluate r_{MSF} , the DEM value associated with DPGA shall be used.

3106F.3.1.2 Site Specific Response Procedure. In lieu of the simplified procedure, either one-dimensional or two-dimensional site response analysis may be performed using the ground motion parameters discussed in Section 3103F.4. The computed cyclic stresses at various points within the pertinent soil layers shall be expressed as values of CSR.

3106F.3.2 Residual Strength. The residual undrained shear strength may be estimated from Figure 7.7 of SCEC [6.3]. When necessary, a conservative extrapolation of the range should be made. Under no circumstances, shall the residual shear strength be higher than the shear strength based on effective strength parameters.

The best estimate value should correspond to $1/3$ from the lower bound of the range for a given value of equivalent clean sand SPT blowcount. When a value other than the " $1/3$ value" is selected for the residual shear strength, the selection shall be justified. An alternate method is provided in Stark and Mesri [6.5]. The residual strength of liquefied soils may be obtained as a function of effective confining pressures if a justification is provided. The resulting residual shear strength shall be used as the postearthquake shear strength of liquefied soils.

3106F.4 Other Geotechnical Hazards. For a SF less than 1.4, the potential for the following hazards shall be evaluated:

1. Flow slides
2. Slope movements
3. Lateral spreading
4. Ground settlement and differential settlement
5. Other surface manifestations

These hazards shall be evaluated, using the residual shear strength described above (Section 3106F.3.2).

3106F.4.1 Stability of Earth Structures. If a slope failure could affect the MOT, a stability analysis of slopes and earth retaining structures shall be performed. The analysis shall use limit equilibrium methods that satisfy all of the force and/or moment equilibrium conditions and determine the slope stability safety factor.

1. Slope stability safety factor ≥ 1.2

Flow slides can be precluded; however, seismically induced ground movements shall be addressed.

2. $1.0 \leq$ Slope stability safety factor < 1.2

Seismically induced ground movements should be evaluated using the methods described below.

3. Slope stability safety factor < 1.0

Mitigation measures shall be implemented per Section 3106F.6.

3106F.4.2 Simplified Ground Movement Analysis. The seismically induced ground settlement may be estimated using Section 7.6 of SCEC [6.3]. Surface manifestation of liquefaction may be evaluated using Section 7.7 of SCEC. Results shall be evaluated to determine if mitigation measures are required.

Seismically induced deformation or displacement of slopes shall be evaluated using the Makdisi-Seed [6.6] simplified method as described below.

The stability analysis shall be used with the residual shear strengths of soils to estimate the yield acceleration coefficient, K_y , associated with the critical potential movement plane. In general, the DPGA shall be used as K_{max} (see [6.6]) and DEM as the earthquake magnitude, M . These parameters shall be used together with the upper bound curves Figures 9 - 11 of [6.6], to estimate the seismically induced ground movement along the critical plane.

However, the value of K_{max} may be different from the DPGA value to include the effects of amplification, incoherence, etc. When such adjustments are made in converting DPGA to K_{max} , a justification shall be provided. Linear interpolation using the upper bound curves in Figure 10 (ordinate scale should be divided by 10) in [6.6] or Figure 4-10 in Ferritto et al [6.7] can be used to estimate the seismically induced ground movement for other earthquake magnitudes.

For screening purposes only, lateral spreading shall be evaluated, using the simplified equations in Youd et al. [6.8]. The total seismically induced ground displacement shall include all contributory directions.

1. When the resulting displacement from the screening method is > 0.1 ft., the Makdisi-Seed simplified method or other similar methods shall be used to estimate lateral spreading.

2. If the computed displacement from the simplified method(s) is ≤ 0.5 ft., the effects can be neglected.

3. If the computed displacements using simplified methods are > 0.5 ft., the use of a detailed ground movement analysis (see Section 3106F.4.3) may be considered.

4. If the final resulting displacement, regardless of the method used, remains > 0.5 ft., it shall be considered in the structural analysis.

3106F.4.3 Detailed Ground Movement Analysis. As an alternative to the simplified methods discussed above, a two-dimensional (2-D) equivalent linear or nonlinear dynamic analysis of the MOT and/or slopes and earth retaining systems may be performed.

An equivalent linear analysis is adequate when the stiffness and/or strength of the soils involved are likely to degrade by less than one-third, during seismic excitation of less than 0.5 g's. Appropriate time histories need to be obtained to calculate seismically induced displacement (see Section 3103F.4.2). Such analysis should account for the accumulating effects of displacement if double-integration of acceleration time histories is used. The seismic stresses or stress time histories from equivalent linear analysis may be used to estimate seismically induced deformation.

A nonlinear analysis should be used if the stiffness and/or strength of the soils involved are likely to degrade by more than one-third during seismic motion.

If the structure is included in the analysis, the ground motion directly affects the structural response. Otherwise, the uncoupled,

calculated movement of the soil on the structure shall be evaluated.

3106F.5 Soil Structure Interaction.

3106F.5.1 Soil Parameters. Soil structure interaction (SSI) shall be addressed for the seismic evaluation of MOT structures. SSI may consist of linear or non-linear springs (and possibly dashpots) for various degrees of freedom, including horizontal, vertical, torsional, and rotational, as required by the structural analysis.

Pile capacity parameters may be evaluated using the procedures in Chapter 4 of FEMA 356 [6.9]. The “p-y” curves, “t-z” curves, and tip load — displacement curves for piles (nonlinear springs for horizontal and vertical modes and nonlinear vertical springs for the pile tip, respectively) and deep foundations shall be evaluated using Section G of API RP 2A-LRFD [6.10] including the consideration of pile group effects. Equivalent springs (and dashpots) representing the degrading properties of soils may be developed.

Where appropriate, alternative procedures can be used to develop these parameters. Rationale for the use of alternative procedures shall be provided. One simplified method is presented in Chapter 5 of the Naval Design Manual 7.02 [6.11] and provides deflection and moment for an isolated pile, subject to a lateral load.

3106F.5.2 Shallow Foundations. Shallow foundations shall be assumed to move with the ground. Springs and dashpots may be evaluated as per Gazetas [6.12].

3106F.5.3 Underground Structures. Buried flexible structures or buried portions of flexible structures including piles and pipelines shall be assumed to deform with estimated ground movement at depth.

As the soil settles, it shall be assumed to apply shear forces to buried structures or buried portions of structures including deep foundations.

3106F.6 Mitigation Measures and Alternatives. If the hazards and consequences addressed in Sections 3106F.3 and 3106F.4 are beyond the specified range, the following options shall be considered:

1. Perform a more sophisticated analysis
2. Modify the structure
3. Modify the foundation soil

Examples of possible measures to modify foundation soils are provided in Table 4-1 of [6.7].

3106F.7 Symbols.

- SF = Safety Factor
 CRR = Cyclic Resistance Ratio
 CSR = Cyclic Stress Ratio induced by DPGA
 g = Gravitational constant
 σ_v = the vertical total stress
 $\sigma'v$ = the vertical effective stress
 r_d = a stress reduction factor
 r_{MSF} = the magnitude scaling factor

3106F.8 References.

- [6.1] American Society for Testing and Materials (ASTM), 2002, “D4318-00 Standard Test Methods for Liquid Limit, Plastic Limit, and Plasticity Index of Soils,” West Conshohocken, PA
- [6.2] American Society for Testing and Materials (ASTM), 2002, “D2216-98 Standard Test Method for Laboratory Determination of Water (Moisture) Content of Soil and Rock by Mass,” West Conshohocken, PA.
- [6.3] Southern California Earthquake Center (SCEC), March 1999, “Recommended Procedures for Implementation of DMG Special Publication 117 Guidelines for Analyzing and Mitigating Liquefaction in California,” University of Southern California, Los Angeles.
- [6.4] Seed, R.B. and Harder, C.F., 1999, SPT-Based Analysis of Cyclic Pore Pressure Generation and Undrained Residual Strength, Proceedings of the H.B. Seed Memorial Symposium, Editor: J.M. Duncan, BiTech Publishers Ltd., v. 2, pp. 351-376.
- [6.5] Stark, T.D., and Mesri, G., 1992, Undrained shear strength of liquefied sands for stability analysis, Journal of Geotechnical Engineering, American Society of Civil Engineers, v118, n11, pp 1727-1747.
- [6.6] Makdisi, F.I. and Seed, H.B., “Simplified Procedure for Estimating Dam and Embankment Earthquake-Induced Deformations”, ASCE Journal of the Geotechnical Engineering Division, Vol. 104, No. 7, pp. 849-867.
- [6.7] Ferritto, J., Dickenson, S., Priestley N., Werner, S., Taylor, C., Burke D., Seelig W., and Kelly, S., 1999, “Seismic Criteria for California Marine Oil Terminals,” Vol.1 and Vol.2, Technical Report TR-2103-SHR, Naval Facilities Engineering Service Center, Port Hueneme, CA.
- [6.8] Youd, T. L., Hansen, C. M., and Bartlett, S. F., “Revised MLRE equations for Predicting Lateral Spread Displacement” Proceedings of the 7th U.S.-Japan Workshop on Earthquake Resistant Design of Lifeline Facilities and Countermeasures Against Soil Liquefaction, 1999.”
- [6.9] Federal Emergency Management Agency, FEMA-356, Nov. 2000, “Prestandard and Commentary for the Seismic Rehabilitation of Buildings,” Washington, D.C.
- [6.10] American Petroleum Institute, July 1993, Recommended Practice 2A-LRFD (API RP 2A-LRFD), “Recommended Practice for Planning, Designing and Constructing Fixed Offshore Platforms—Load and Resistance Factor Design,” Washington, D.C.
- [6.11] “Foundations and Earth Structures”, Design Manual 7.02, Chapter 5, 1986, Naval Facilities Engineering Command, Alexandria, VA.
- [6.12] Gazetas, G., “Formulas and Charts for Impedances of Surface and Embedded Foundations”, Journal of Geotechnical Engineering, ASCE, Vol. 117, No. 9, September, 1991.

Authority: Sections 8755 and 8757, Public Resources Code.
 Reference: Sections 8750, 8751, 8755 and 8757, Public Resources Code.

Division 7

SECTION 3107F — STRUCTURAL ANALYSIS AND DESIGN OF COMPONENTS

3107F.1 General.

3107F.1.1 Purpose. This section establishes the minimum performance standards for structural components. Evaluation procedures for seismic performance, strength and deformation characteristics of concrete, steel and timber components are prescribed herein. Analytical procedures for structural systems are presented in Section 3104F.

3107F.1.2 Applicability. This section addresses MOTs constructed using the following structural components:

1. Reinforced concrete decks supported by batter and/or vertical concrete piles
2. Reinforced concrete decks supported by batter and/or vertical steel piles, including pipe piles filled with concrete
3. Reinforced concrete decks supported by batter and/or vertical timber piles
4. Timber decks supported by batter or vertical timber, concrete or steel pipe piles

3107F.2 Concrete Deck with Concrete or Steel Piles.

3107F.2.1 Component Strength. The following parameters shall be established in order to compute the component strength:

1. Specified concrete compressive strengths
2. Concrete and steel modulus of elasticity
3. Yield and tensile strength of mild reinforcing and prestressed steel and corresponding strains
4. Confinement steel strength and corresponding strains
5. Embedment length
6. Concrete cover
7. Yield and tensile strength of structural steel
8. Ductility

In addition, for “existing” components, the following conditions shall be considered:

9. Environmental effects, such as reinforcing steel corrosion, concrete spalling, cracking and chemical attack
10. Fire damage
11. Past and current loading effects, including overload, fatigue or fracture
12. Earthquake damage
13. Discontinuous components

14. Construction deficiencies

3107F.2.1.1 Material Properties. Material properties of existing components, not determined from testing procedures, and of new components, shall be established using the following methodology.

The strength of structural components shall be evaluated based on realistic upper bound estimates of material properties, except for nonductile components, which shall be evaluated based on design material properties. The following values shall be substituted (Section 5.3 of [7.1] and p. 3-73 & 3-74 of [7.2]):

Non-ductile components (shear):

$$f'_c = 1.0 f'_c \quad (7-1a)$$

$$f_y = 1.0 f_y \quad (7-1b)$$

$$f_p = 1.0 f_p \quad (7-1c)$$

Other components (moment, axial):

$$f'_c = 1.3 f'_c \quad (7-2a)$$

$$f_y = 1.1 f_y \quad (7-2b)$$

$$f_p = 1.0 f_p \quad (7-2c)$$

Capacity protected members, such as pile caps and joints (maximum demand):

$$f'_c = 1.7 f'_c \quad (7-3a)$$

$$f_y = 1.3 f_y \quad (7-3b)$$

$$f_p = 1.1 f_p \quad (7-3c)$$

WHERE:

f'_c = Compressive strength of concrete

f_y = Yield strength of steel

f_p = Yield strength of prestress strands

“Capacity Design” (Section 5.3 of [7.1]) ensures that the strength at protected locations are greater than the maximum feasible demand, based on realistic upper bound estimates of plastic hinge flexural strength. In addition, a series of pushover analyses using moment curvature characteristics of pile hinges may be required.

Alternatively, if a moment-curvature analysis is performed that takes into account the strain hardening of the steel, the demands used to evaluate the capacity protected components may be estimated by multiplying the moment-curvature values by 1.25.

Based on a historical review of the building materials used in the twentieth century, guidelines for tensile and yield properties of concrete reinforcing bars and the compressive strength of structural concrete have been established (see Tables 6-1 to 6-3 of FEMA 356 [7.3]). The values shown in these tables can be used as default properties, only if as-built information is not available and testing is not performed. The values in Tables 31F-7-1 and 31F-7-2, are adjusted according to equations (7-1) through (7-3).

**TABLE 31F-7-1
COMPRESSIVE STRENGTH OF STRUCTURAL CONCRETE (psi)¹**

TIME FRAME	PILING	BEAMS	SLABS
1900-1919	2,500-3,000	2,000-3,000	1,500-3,000
1920-1949	3,000-4,000	2,000-3,000	2,000-3,000
1950-1965	4,000-5,000	3,000-4,000	3,000-4,000
1966-present	5,000-6,000	3,000-5,000	3,000-5,000

¹Concrete strengths are likely to be highly variable for an older structure.

**TABLE 31F-7-2
TENSILE AND YIELD PROPERTIES OF REINFORCING BARS FOR VARIOUS ASTM SPECIFICATIONS AND PERIODS
(after Table 6-2 of [7.3])**

ASTM	STEEL TYPE	YEAR RANGE ³	GRADE	STRUCTURAL ¹	INTERMEDIATE ¹	HARD ¹			
			33	40	50	60	70	75	
			Minimum Yield ² (psi)	33,000	40,000	50,000	60,000	70,000	75,000
			Minimum Tensile ² (psi)	55,000	70,000	80,000	90,000	80,000	100,000
A15	Billet	1911-1966		X	X	X			
A16	Rail ⁴	1913-1966				X			
A61	Rail ⁴	1963-1966					X		
A160	Axle	1936-1964		X	X	X			
A160	Axle	1965-1966		X	X	X	X		
A408	Billet	1957-1966		X	X	X			
A431	Billet	1959-1966							X
A432	Billet	1959-1966					X		
A615	Billet	1968-1972			X		X		X
A615	Billet	1974-1986			X		X		
A615	Billet	1987-1997			X		X		X
A616	Rail ⁴	1968-1997				X	X		
A617	Axle	1968-1997			X		X		
A706	Low-Alloy ⁵	1974-1997						X	
A955	Stainless	1996-1997			X		X		X

General Note: An entry "X" indicates that grade was available in those years.

¹The terms structural, intermediate and hard became obsolete in 1968.

²Actual yield and tensile strengths may exceed minimum values.

³Until about 1920, a variety of proprietary reinforcing steels were used. Yield strengths are likely to be in the range from 33,000 psi to 55,000 psi, but higher values are possible. Plain and twisted square bars were sometimes used between 1900 and 1949.

⁴Rail bars should be marked with the letter "R."

⁵ASTM steel is marked with the letter "W."

3107F.2.1.2 Knowledge Factor (k). Knowledge factor, k, shall be applied on a component basis.

The following information is required, at a minimum, for a component strength assessment:

1. Original construction records, including drawings and specifications.
2. A set of "as-built" drawings and/or sketches, documenting both gravity and lateral systems (Section 3102F.1.5) and any post-construction modification data.
3. A visual condition survey, for structural components including identification of the size, location and connections of these components.
4. In the absence of material properties, values from limited in-situ testing or conservative estimates of material properties (Tables 31F-7-1 and 31F-7-2).
5. Assessment of component conditions, from an in-situ evaluation, including any observable deterioration.
6. Detailed geotechnical information, based on recent test data, including risk of liquefaction, lateral spreading and slope stability.

The knowledge factor, k, is 1.0 when comprehensive knowledge as specified above is utilized. Otherwise, the knowledge factor shall be 0.75. Further guidance on the determination of the appropriate k value can be found in Table 2-1 of FEMA 356 [7.3].

3107F.2.2 Component Stiffness. Stiffness that takes into account the stress and deformation levels experienced by the component shall be used. Nonlinear load-deformation relations shall be used to represent the component load-deformation response. However,

in lieu of using nonlinear methods to establish the stiffness and moment curvature relation of structural components, the equations of Table 31F-7-3 may be used to approximate the effective elastic stiffness, EI_e , for lateral analyses (see Section 3107F.5 for definition of symbols).

**TABLE 31F-7-3
EFFECTIVE ELASTIC STIFFNESS**

CONCRETE COMPONENT	EI_e / EI_g
Reinforced Pile	$0.3 + N / (f'_c A_g)$
Pile/Deck Dowel Connection ¹	$0.3 + N / (f'_c A_g)$
Prestressed Pile ¹	$0.6 < EI_e / EI_g < 0.75$
Steel Pile	1.0
Concrete w/Steel Casing	$\frac{E_s I_s + 0.25 E_c I_c}{(E_s I_s + E_c I_c)}$
Deck	0.5

¹The pile/deck connection and prestressed pile may also be approximated as one member with an average stiffness of $0.42 EI_e / EI_g$ (Ferritto et al, 1999 [7.2])

N = is the axial load level.

E_s = Young's modulus for steel

I_s = Moment of inertia for steel section

E_c = Young's modulus for concrete

I_c = Moment of inertia for uncracked concrete section

3107F.2.3 Deformation Capacity of Flexural Members. Stress-strain models for confined and unconfined concrete, mild and prestressed steel presented in Section 3107F.2.4 shall be used to perform the moment-curvature analysis.

The stress-strain characteristics of steel piles shall be based on the actual steel properties. If as-built information is not available,

the stress-strain relationship may be obtained per Section 3107F.2.4.2.

For concrete in-filled steel piles, the stress-strain model for confined concrete shall be in accordance with Section 3107F.2.4.1.

Each structural component expected to undergo inelastic deformation shall be defined by its moment-curvature relation. The displacement demand and capacity shall be calculated per Sections 3104F.2 and 3104F.3, as appropriate.

The moment-rotation relationship for concrete components shall be derived from the moment-curvature analysis per Section 3107F.2.5.4 and shall be used to determine lateral displacement limitations of the design. Connection details shall be examined per Section 3107F.2.7.

3107F.2.4 Stress-Strain Models.

3107F.2.4.1 Concrete. The stress-strain model and terms for confined and unconfined concrete are shown in Figure 31F-7-1.

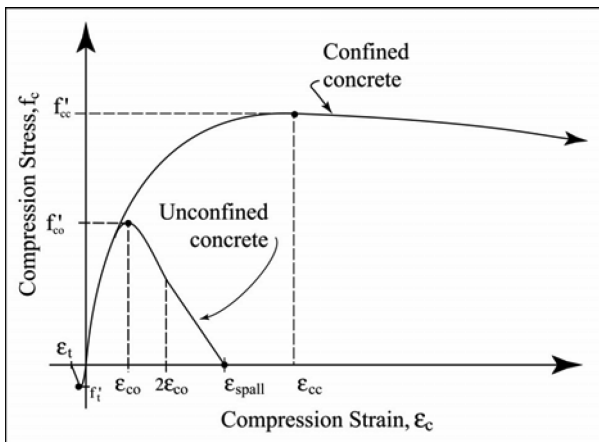

FIGURE 31F-7-1—STRESS-STRAIN CURVES FOR CONFINED AND UNCONFINED CONCRETE [7.1]

3107F.2.4.2 Reinforcement Steel and Structural Steel. The stress-strain model and terms for reinforcing and structural steel are shown in Figure 31F-7-2.

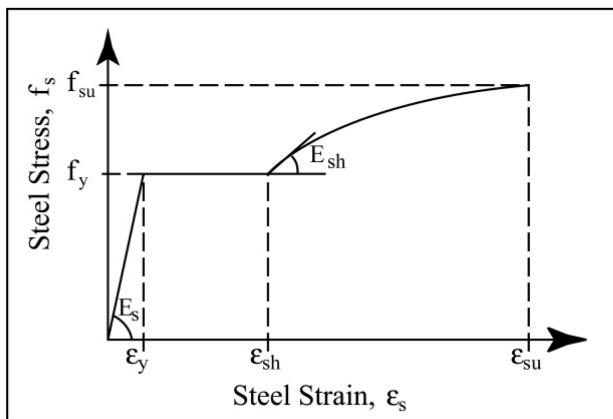

FIGURE 31F-7-2—STRESS-STRAIN CURVE FOR MILD REINFORCING STEEL OR STRUCTURAL STEEL [7.1]

3107F.2.4.3 Prestressed Steel. The stress-strain model of Blakeley and Park [7.4] may be used for prestressed steel. The model and terms are illustrated in Figure 31F-7-3.

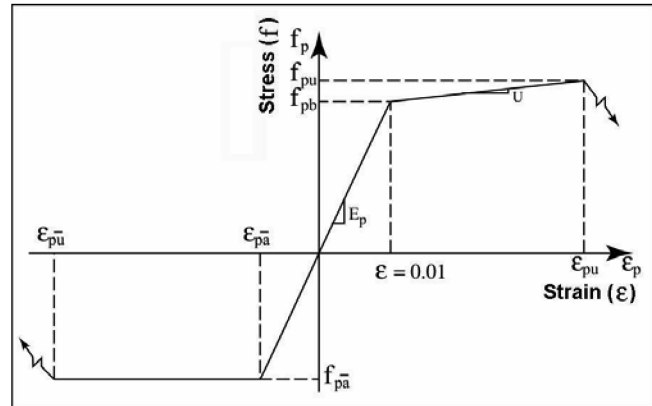

FIGURE 31F-7-3—STRESS-STRAIN CURVE FOR PRESTRESSED STEEL [7.4]

3107F.2.4.4 Alternative Stress-Strain Models. Alternative stress-strain models are acceptable if adequately documented and supported by test results, subject to Division approval.

3107F.2.5 Concrete Piles.

3107F.2.5.1 General. The capacity of concrete piles is based on permissible concrete and steel strains corresponding to the desired performance criteria.

Different values may apply for plastic hinges forming at in-ground and pile-top locations. These procedures are applicable to circular, octagonal, rectangular and square pile cross sections.

3107F.2.5.2 Stability. Stability considerations are important to pier-type structures. The moment-axial load interaction shall consider effects of high slenderness ratios (kl/r). An additional bending moment due to axial load eccentricity shall be incorporated unless:

$$e/h \leq 0.10 \tag{7-4}$$

WHERE:

- e = eccentricity of axial load
- h = width of pile in considered direction

3107F.2.5.3 Plastic Hinge Length. The plastic hinge length is required to convert the moment-curvature relationship into a moment-plastic rotation relationship for the nonlinear pushover analysis.

The pile's plastic hinge length, L_p (above ground), when the plastic hinge forms against a supporting member is:

$$L_p = 0.08L + 0.15 f_{ye} d_{bl} \geq 0.3 f_{ye} d_{bl} \tag{7-5}$$

WHERE:

- L = the distance from the critical section of the plastic hinge to the point of contraflexure
- d_{bl} = the diameter of the longitudinal reinforcement
- f_{ye} = design yield strength of longitudinal reinforcement (ksi)

If a large reduction in moment capacity occurs due to spalling, then the plastic hinge length shall be:

$$L_p = 0.3 f_{ye} d_{bl} \tag{7-6}$$

When the plastic hinge forms in-ground, the plastic hinge length may be determined from Figure 31F-7-4 (see page 311 of [7.1]).

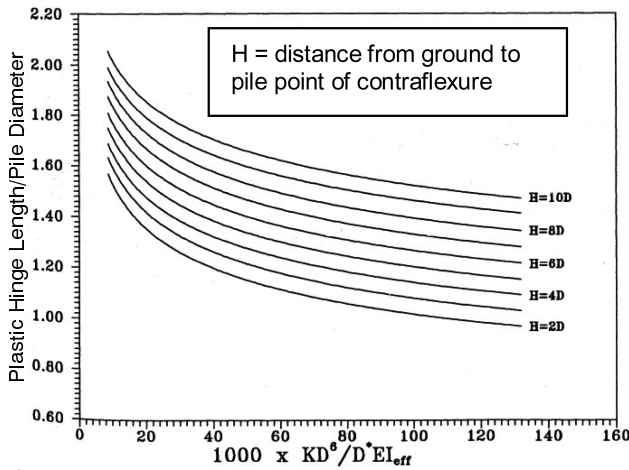

FIGURE 31F-7-4—INFLUENCE OF PILE/SOIL STIFFNESS RATIO ON PLASTIC HINGE LENGTH (after Fig. 5.30 of [7.1])

The stiffness parameter (x-axis) is:

$$\frac{KD^6}{[D^*]EI_e} \tag{7-7}$$

WHERE:

- EI_e = the effective stiffness
- K = the subgrade modulus
- D = pile diameter
- D^* = reference diameter of 6 ft

If site specific soil information is not available then the values for K in Table 31F-7-4 may be used.

TABLE 31F-7-4
SUBGRADE MODULUS K

SOIL TYPE	AVG UNDRAINED SHEAR STRENGTH [psf]	SUBGRADE MODULUS K [lb/in ²]
Soft Clay	250-500	30
Medium Clay	500-1000	100
Stiff Clay	1000-2000	500
Very Stiff Clay	2000-4000	1000
Hard Clay	4000-8000	2000
Loose Sand (above WT/submerged)	—	25/20
Medium Sand (above WT/submerged)	—	90/60
Dense Sand (above WT/submerged)	—	275/125

3107F.2.5.4 Plastic Rotation. The plastic rotation, θ_p , can be determined from Equation 7-8, by using moment-curvature analysis and applicable strain limitations, as shown in Figure 31F-7-5.

The plastic rotation is:

$$\theta_p = L_p \phi_p = L_p (\phi_m - \phi_y) \tag{7-8}$$

WHERE:

- L_p = plastic hinge length
- ϕ_p = plastic curvature
- ϕ_m = maximum curvature
- ϕ_y = yield curvature

The maximum curvature, ϕ_m , shall be determined by the concrete or steel strain limit state at the prescribed performance level, whichever comes first.

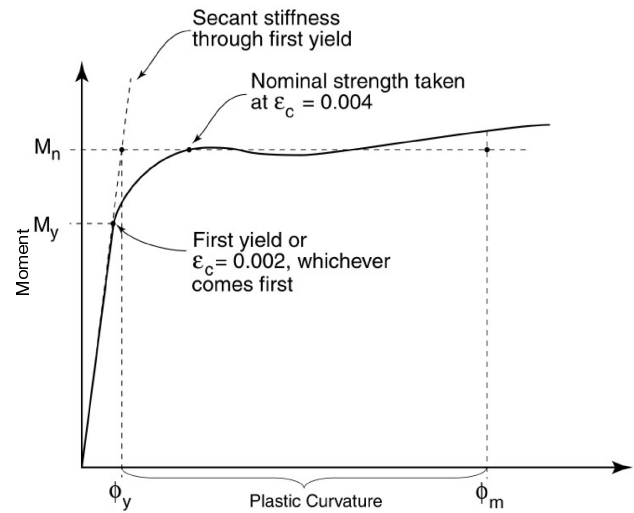

FIGURE 31F-7-5—MOMENT CURVATURE ANALYSIS

Alternatively, the maximum curvature, ϕ_m , may be calculated as:

$$\phi_m = \frac{\epsilon_{cm}}{C_u} \tag{7-9}$$

WHERE:

- ϵ_{cm} = max limiting compression strain for the prescribed performance level (Table 31F-7-5)
- C_u = neutral-axis depth, at ultimate strength of section

The yield curvature, ϕ_y is the curvature at the intersection of the secant stiffness, EI_c , through first yield and the nominal strength, ($\epsilon_c = 0.004$)

$$\phi_y = \frac{M_y}{EI_c} \tag{7-10}$$

3107F.2.5.5 Ultimate Concrete and Steel Flexural Strains. Strain values computed in the nonlinear pushover analysis shall be compared to the following limits for flexure:

3107F.2.5.5.1 Unconfined concrete piles: An unconfined concrete pile is defined as a pile having no confinement steel or one in which the spacing of the confinement steel exceeds 12 inches.

Ultimate concrete compressive strain:

$$\epsilon_{cu} = 0.005 \tag{7-11}$$

3107F.2.5.5.2 Confined concrete piles:

Ultimate concrete compressive strain [7.1]:

$$\epsilon_{cu} = 0.004 + (1.4\rho_s f_{yh} \epsilon_{sm}) / f'_{cc} \geq 0.005 \tag{7-12}$$

$$\epsilon_{cu} \leq 0.035$$

WHERE:

- ρ_s = effective volume ratio of confining steel
- f_{yh} = yield stress of confining steel
- ϵ_{sm} = strain at peak stress of confining reinforcement, 0.15 for grade 40, 0.12 for grade 60 and 0.10 for A82 grade 70 plain spiral
- f'_{cc} = confined strength of concrete approximated by $1.5 f'_c$

3107F.2.5.6 Component Acceptance/Damage Criteria. The maximum allowable concrete strains may not exceed the ultimate

values defined in Section 3107F.2.5.5. The following limiting values (Table 31F-7-5) apply for each performance level for both existing and new structures. The "Level 1 or 2" refer to the seismic performance criteria (see Section 3104F.2.1).

For all nonseismic loading combinations, concrete components shall be designed in accordance with the ACI requirements [7.5].

Note that for existing facilities, the pile/deck hinge may be controlled by the capacity of dowel reinforcement in accordance with Section 317F.2.7.

**TABLE 31F-7-5
LIMITS OF STRAIN**

COMPONENT STRAIN	LEVEL 1	LEVEL 2
MCCS Pile/deck hinge	$\epsilon_c \leq 0.005$	$\epsilon_c \leq 0.025$
MCCS In-ground hinge	$\epsilon_c \leq 0.005$	$\epsilon_c \leq 0.008$
MRSTS	$\epsilon_s \leq 0.01$	$\epsilon_s \leq 0.05$
MPSTS In-ground hinge	$\epsilon_p \leq 0.005$ (incremental)	$\epsilon_p \leq 0.04$ (total strain)

MCCS = Maximum Concrete Compression Strain, ϵ_c
MRSTS = Maximum Reinforcing Steel Tension Strain, ϵ_s
MPSTS = Maximum Prestressing Steel Tension Strain, ϵ_p

3107F.2.5.7 Shear Capacity (Strength). Shear strength shall be based on nominal material strengths, and reduction factors according to ACI-318 [7.5].

To account for material strength uncertainties, maximum shear demand, $V_{max,push}$ established from nonlinear pushover analyses shall be multiplied by 1.4 (Section 8.16.4.4.2 of ATC-32 [7.6]):

$$V_{design} = 1.4V_{max,push} \quad (7-13)$$

If moment curvature analysis that takes into account strain-hardening, an uncertainty factor of 1.25 may be used:

$$V_{design} = 1.25V_{max,push} \quad (7-14)$$

If the factors defined in Section 31F-7.2.1.1 are used, the above uncertainty factors need not be applied.

As an alternative, the method of Kowalski and Priestley [7.7] may be used. This is based on a three-parameter model with separate contributions to shear strength from concrete (V_c), transverse reinforcement (V_s), and axial load (V_p) to obtain nominal shear strength (V_n):

$$V_n = V_c + V_s + V_p \quad (7-15)$$

A shear strength reduction factor of 0.85 shall be applied to the nominal strength, V_n , to determine the design shear strength. Therefore:

$$V_{design} \leq 0.85 V_n \quad (7-16)$$

The equations to determine V_c , V_s and V_p are:

$$V_c = k \sqrt{f'_c} A_e \quad (7-17)$$

WHERE:

k = factor dependent on the curvature ductility

$\mu_\phi = \frac{\phi}{\phi_y}$, within the plastic hinge region, from Figure 31F-7-6. For regions greater than $2D_p$ (see eqn. 7-18) from the plastic hinge location, the strength can be based on $\mu_\phi = 1.0$ (see Ferritto et. al. [7.2]).

f'_c = concrete compressive strength

$A_e = 0.8A_g$ is the effective shear area

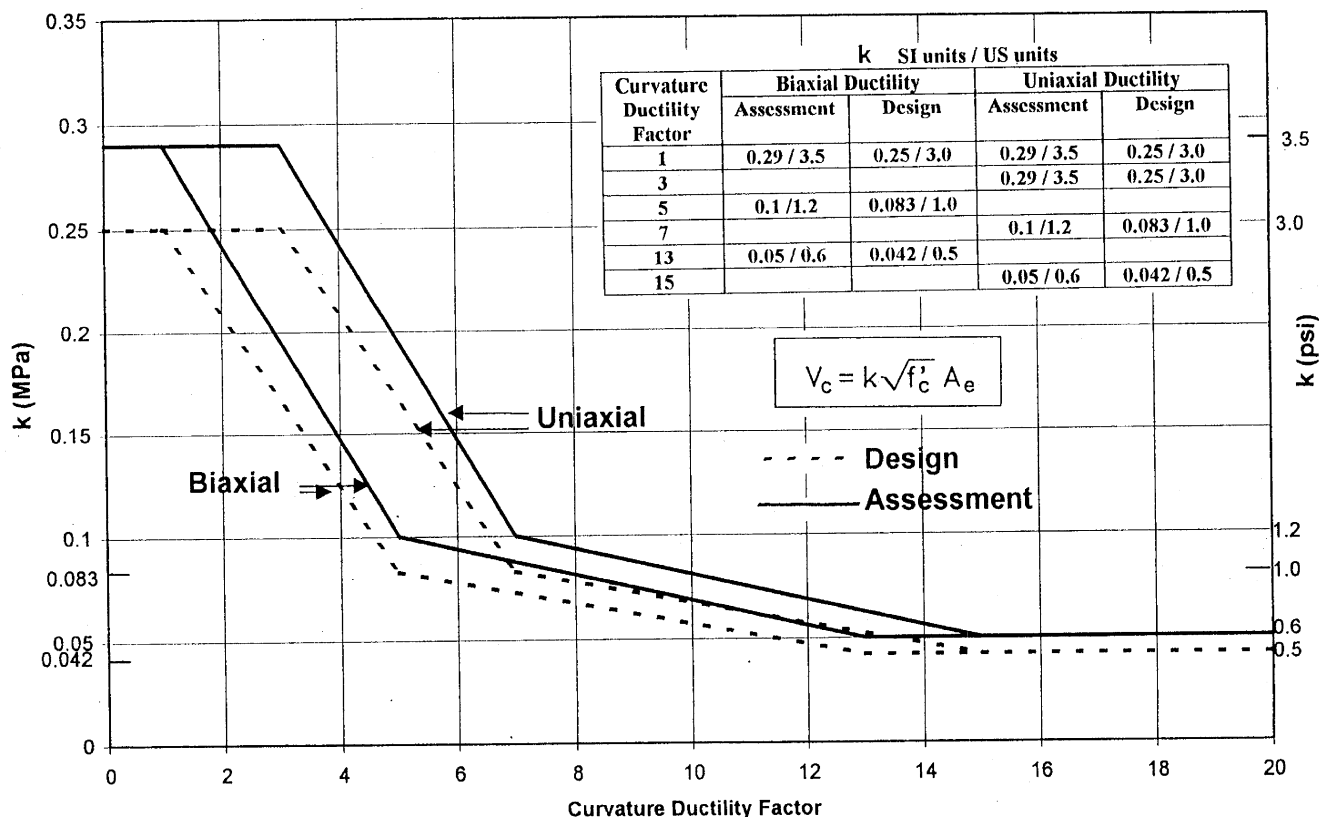

FIGURE 31F-7-6—CONCRETE SHEAR MECHANISM
(from Fig. 3-30 of [7.2])

Circular spirals or hoops [7.2]:

$$V_s = \frac{\pi A_{sp} f_{yh} (D_p - c - c_o) \cot(\theta)}{s} \quad (7-18)$$

WHERE:

- A_{sp} = spiral or hoop cross section area
- f_{yh} = yield strength of transverse or hoop reinforcement
- D_p = pile diameter or gross depth (in case of a rectangular pile with spiral confinement)
- c = depth from extreme compression fiber to neutral axis (N.A.) at flexural strength (see Fig. 31F-7-7)
- c_o = concrete cover to center of hoop or spiral (see Fig. 31F-7-7)
- θ = angle of critical crack to the pile axis (see Fig. 31F-7-7) taken as 30° for existing structures, and 35° for new design
- s = spacing of hoops or spiral along the pile axis

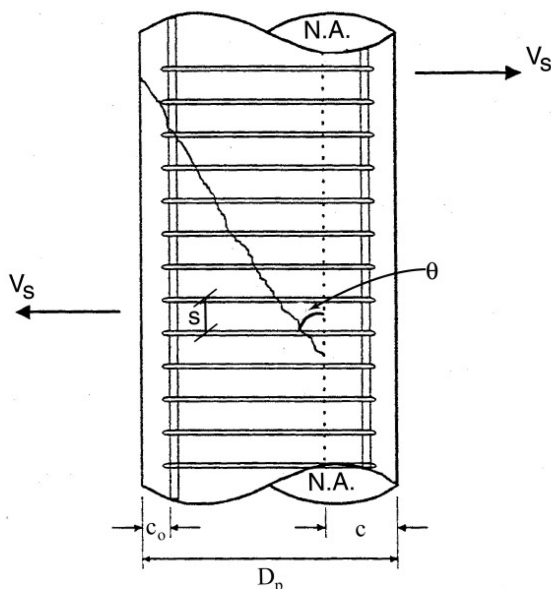

FIGURE 31F-7-7—TRANSVERSE SHEAR MECHANISM

Rectangular hoops or spirals [7.2]:

$$V_s = \frac{A_{th} f_{yh} (D_p - c - c_o) \cot(\theta)}{s} \quad (7-19)$$

WHERE:

- A_{th} = total area of transverse reinforcement, parallel to direction of applied shear cut by an inclined shear crack
- Shear strength from axial mechanism, V_p (see Fig. 31F-7-8):

$$V_p = \Phi (N_u + F_p) \tan \alpha \quad (7-20)$$

WHERE:

- N_u = external axial compression on pile including seismic load. Compression is taken as positive; tension as negative
- F_p = prestress compressive force in pile
- α = angle between line joining centers of flexural compression in the deck/pile and in-ground hinges, and the pile axis
- Φ = 1.0 for existing structures, and 0.85 for new design

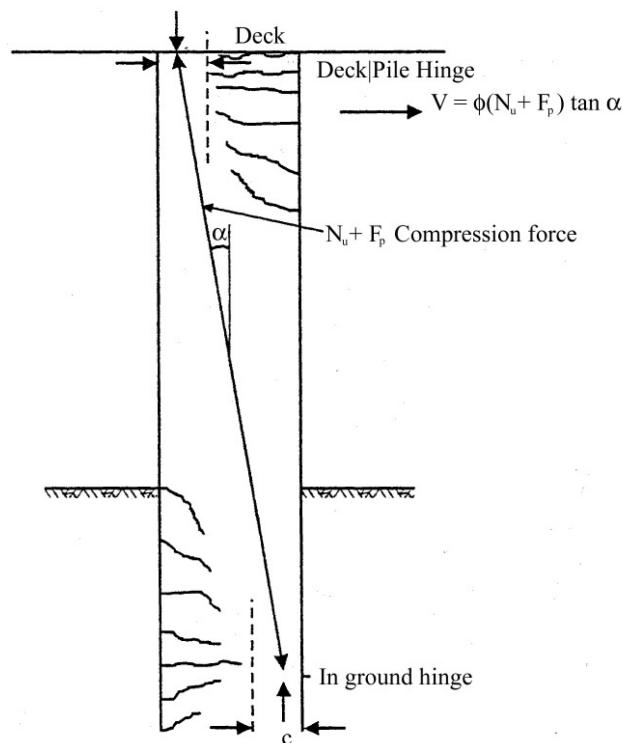

FIGURE 31F-7-8—AXIAL FORCE SHEAR MECHANISM

3107F.2.6 Steel Piles.

3107F.2.6.1 General. The capacity of steel piles is based on allowable strains corresponding to the desired performance criteria and design earthquake.

3107F.2.6.2 Stability. Section 3102F.2.5.2 applies to steel piles.

3107F.2.6.3 Plastic Hinge Length. The plastic hinge length depends on the section shape and the slope of the moment diagram in the vicinity of the plastic hinge.

For plastic hinges forming in steel piles at the deck/pile interface and where the hinge forms in the steel section rather than in a special connection detail (such as a reinforced concrete dowel connection), allowance should be made for strain penetration into the pile cap. This increase may be taken as 0.25D_p, where D_p is the pile diameter or pile depth in the direction of the applied shear force.

3107F.2.6.4 Ultimate Flexural Strain Capacity. The following limiting value applies:

$$\text{Strain at extreme-fiber, } \epsilon_u \leq 0.035$$

3107F.2.6.5 Component Acceptance/Damage Criteria. The maximum allowable strain may not exceed the ultimate value defined in Section 3107F.2.6.4. Table 31F-7-6 provides limiting strain values for each performance level, for both new and existing structures.

Steel components for all nonseismic loading combinations shall be designed in accordance with AISC-LRFD [7.8].

TABLE 31F-7-6
STRUCTURAL STEEL STRAIN LIMITS, ϵ_u

COMPONENTS	LEVEL 1	LEVEL 2
Concrete Filled Pipe	0.008	0.030
Hollow Pipe	0.008	0.025

Level 1 or 2 refer to the seismic performance criteria (Section 3104F.2.1)

3107F.2.6.6 Shear Capacity (Strength). The procedures of Section 3107F.2.5.7 to establish V_{design} are applicable to steel piles (Equations 7-13 and 7-14). If the factors defined in Section 3107F.2.1.1 are used, the knowledge factor need not be applied.

The shear capacity shall be established from the AISC-LRFD [7.8]. For concrete filled pipe, equation 7-15 may be used to determine shear capacity; however, V_{shell} must be substituted for V_s . It thus becomes:

$$V_{shell} = (\pi/2)t f_{y,shell} (D_p - c - c_o) \cot \theta \quad (7-21)$$

WHERE:

- t = shell thickness
 - $f_{y,shell}$ = yield strength of steel shell
 - c_o = outside of steel pipe to center of hoop or spiral
- (All other terms are as listed for equation 7-18).

3107F.2.7 Pile/Deck Connection Strength.

3107F.2.7.1 Joint Shear Capacity. The joint shear capacity shall be computed in accordance with ACI 318 [7.5]. For existing MOTs, the method [7.1, 7.2] given below may be used:

1. Determine the nominal shear stress in the joint region corresponding to the pile plastic moment capacity.

$$v_j = \frac{0.9 M_p}{\sqrt{2} l_{dv} D_p^2} \quad (7-22)$$

WHERE:

- v_j = Nominal shear stress
- M_p = Overstrength moment of the plastic hinge (the maximum possible moment in the pile) as determined from a pushover analysis at displacements corresponding to the damage control limit state ($1.25 M_n$ when established from moment curvature and 1.3 and 1.1 over-strength factors are applied to f'_c and f_y , respectively, 1.4 otherwise.)
- l_{dv} = Vertical development length, see Figure 31F-7-9
- D_p = Diameter of pile

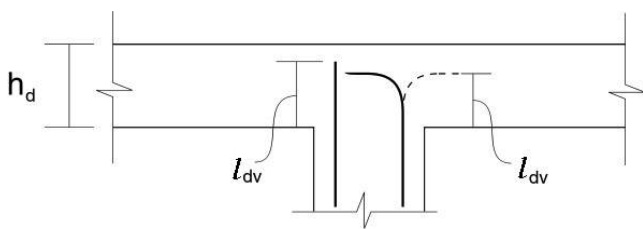

FIGURE 31F-7-9—DEVELOPMENT LENGTH

2. Determine the nominal principal tension p_t , stress in the joint region:

$$p_t = \frac{-f_a}{2} + \sqrt{\left(\frac{f_a}{2}\right)^2 + v_j^2} \quad (7-23)$$

WHERE:

$$f_a = \frac{N}{(D_p + h_d)^2} \quad (7-24)$$

is the average compressive stress at the joint center caused by the pile axial compressive force N and h_d is the deck depth. Note, if the pile is subjected to axial tension under seismic load, the value of N , and f_a will be negative.

If $p_t > 5.0 \sqrt{f'_c}$ psi, joint failure will occur at a lower moment than the column plastic moment capacity M_p . In this case, the maximum moment that can be developed at the pile/deck interface will be limited by the joint principal tension stress capacity, which will continue to degrade as the joint rotation increases, as shown in Figure 31F-7-10. The moment capacity of the connection at which joint failure initiates can be established from equations 7-26 and 7-27.

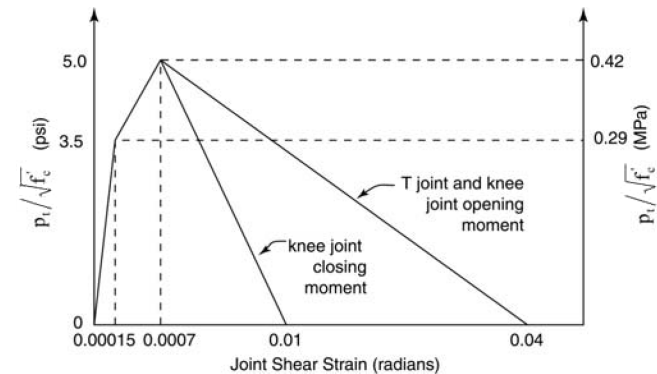

FIGURE 31F-7-10—DEGRADATION OF EFFECTIVE PRINCIPAL TENSION STRENGTH WITH JOINT SHEAR STRAIN (rotation) [7.1, pg. 564]

For $p_t = 5.0 \sqrt{f'_c}$, determine the corresponding joint shear stress, v_j :

$$v_j = \sqrt{p_t - f_a} \quad (7-25)$$

3. The moment capacity of the connection can be approximated as:

$$M_c = \left(\frac{1}{90}\right) \sqrt{2} v_j l_{dv} D_p^2 \leq M_p \quad (7-26)$$

This will result in a reduced strength and effective stiffness for the pile in a pushover analysis. The maximum displacement capacity of the pile should be based on a drift angle of 0.04 radians.

If no mechanisms are available to provide residual strength, the moment capacity will decrease to zero as the joint shear strain increases to 0.04 radians, as shown in Figure 31F-7-11.

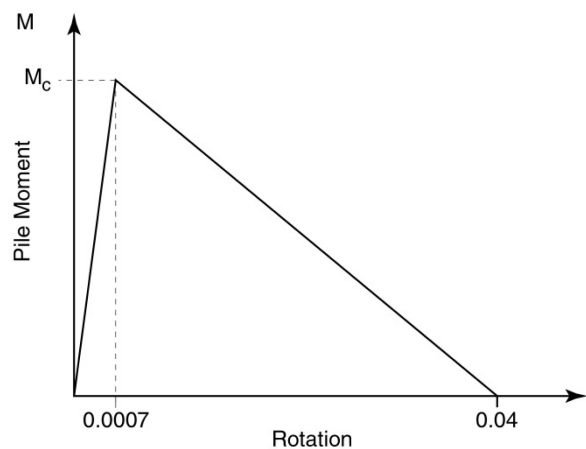

FIGURE 31F-7-11—REDUCED PILE MOMENT CAPACITY

If deck stirrups are present within $h_d/2$ of the face of the pile, the moment capacity, $M_{c,n}$, at the maximum plastic rotation of 0.04 ra-

dians may be increased from zero to the following (see Figure 31F-7-12):

$$M_{c,r} = 2A_s f_y (h_d - d_c) + N \left(\frac{D_p}{2} - d_c \right) \quad (7-27)$$

A_s = Area of slab stirrups on one side of joint

h_d = See Figure 31F-7-9 (deck thickness)

d_c = Depth from edge of concrete to center of main reinforcement

In addition, the bottom deck steel ($A_{s, deckbottom}$) area within $h_d/2$ of the face of the pile shall satisfy:

$$A_{s, deckbottom} \geq 0.5 \cdot A_s \quad (7-28)$$

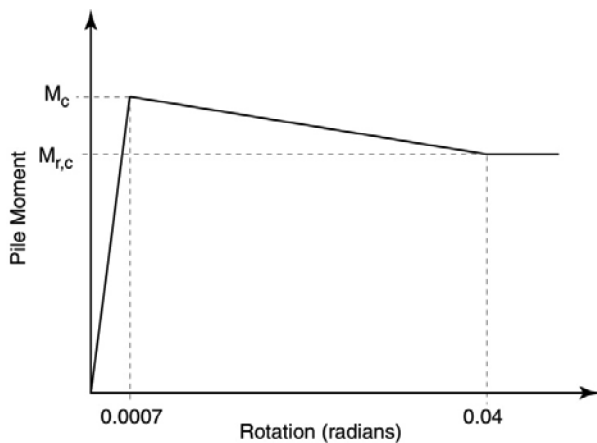

FIGURE 31F-7-12—JOINT ROTATION

4. Using the same initial stiffness as in Section 3107F.2.5.4, the moment-curvature relationship established for the pile top can now be adjusted to account for the joint degradation.

The adjusted yield curvature, ϕ'_u , can be found from:

$$\phi'_y = \frac{\phi_y M_c}{M_n} \quad (7-29)$$

M_n is defined in Figure 31F-7-5.

The plastic curvature, ϕ_p , corresponding to a joint rotation of 0.04 can be calculated as:

$$\phi_p = \frac{0.04}{L_p} \quad (7-30)$$

Where L_p is given by equation 7-5.

The adjusted ultimate curvature, ϕ'_u , can now be calculated as:

$$\phi'_u = \phi_p + \frac{\phi_y M_{c,r}}{M_n} \quad (7-31)$$

Note that $M_{c,r} = 0$ unless deck stirrups are present as discussed above. Examples of adjusted moment curvature relationships are shown in Figure 31F-7-13.

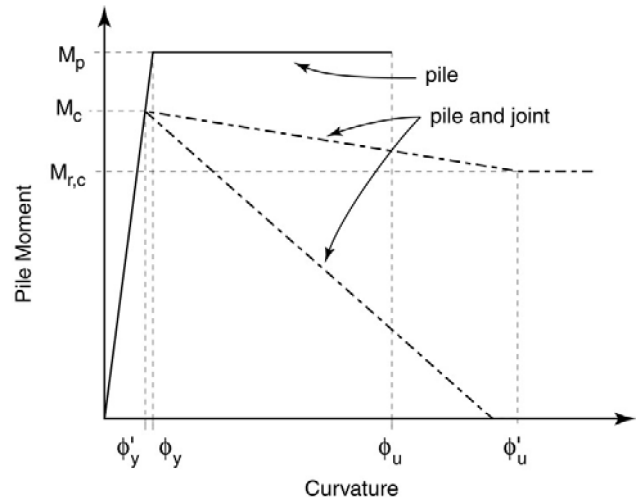

FIGURE 31F-7-13—EQUIVALENT PILE CURVATURE

3107F.2.7.2 **Development Length.** The development length, l_{dc} , is:

$$l_{dc} \geq \frac{0.025 \cdot d_b \cdot f_{ye}}{\sqrt{f'_c}} \quad (7-32)$$

WHERE:

d_b = dowel bar diameter

f_{ye} = expected yield strength of dowel

f'_c = compressive strength of concrete

In assessing existing details, actual or estimated values for f_{ye} and f'_c rather than nominal strength should be used in accordance with Section 3107F.2.1.1.

When the development length is less than that calculated by the equation 7-32, the moment capacity shall be calculated using a proportionately reduced yield strength, $f_{ye,r}$, for the vertical pile reinforcement:

$$f_{ye,r} = f_{ye} \cdot \frac{l_d}{l_{dc}} \quad (7-33)$$

WHERE:

l_d = actual development length

f_{ye} = expected yield strength of dowel

3107F.2.8 **Batter Piles.**

3107F.2.8.1 **Existing Ordinary Batter Piles.** Wharves or piers with ordinary (not fused, plugged or having a seismic release mechanism) batter piles typically have a very stiff response when subjected to lateral loads in the direction of the batter. The structure often maintains most of its initial stiffness all the way to failure of the first row of batter piles. Since batter piles most likely will fail under a Level 2 seismic event, the following method may be used to evaluate the post-failure behavior of the wharf or pier:

1. Identify the failure mechanism of the batter pile-deck connection (refer to Section 3104F.4.7) for typical failure scenarios) and the corresponding lateral displacement.
2. Release the lateral load between the batter pile and the deck when the lateral failure displacement is reached.

3. Push on the structure until subsequent failure(s) have been identified.

As an example, following these steps will result in a force-displacement (pushover) curve similar to the one shown in Figure 31F-7-14 for a wharf supported by one row of batter piles.

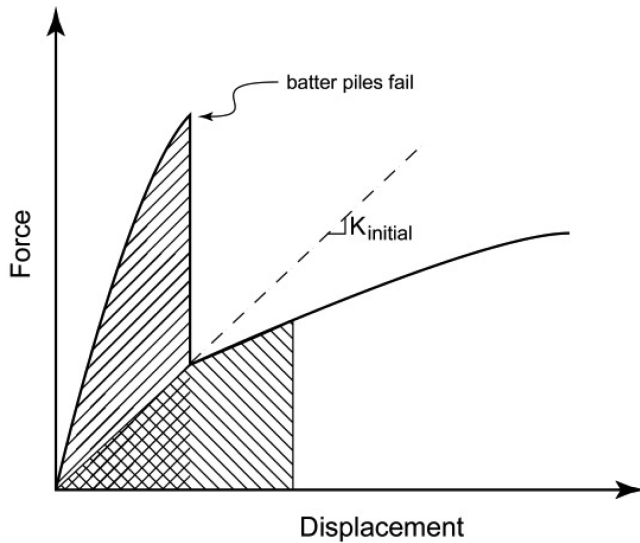

FIGURE 31F-7-14—PUSHOVER CURVE FOR ORDINARY BATTER PILES

When the row of batter piles fail in tension or shear, stored energy will be released. The structure will therefore experience a lateral displacement demand following the nonductile pile failures. If the structure can respond to this displacement demand without exceeding other structural limitations, it may be assumed that the structure is stable and will start to respond to further shaking with a much longer period and corresponding lower seismic demands. The wharf structure may therefore be able to sustain larger seismic demands following the loss of the batter piles than before the loss of pile capacity, because of a much softer seismic response.

The area under the pushover curve before the batter pile failures is compared to the equivalent area under the post failure pushover curve (refer to Figure 31F-7-14). If no other structural limitations are reached with the new displacement demand, it is assumed that the structure is capable of absorbing the energy. It should be noted that even though the shear failure is nonductile, it is expected that energy will be absorbed and the damping will increase during the damage of the piles. The above method is, therefore, considered conservative.

Following the shear failure of a batter pile row, the period of the structure increases such that equal displacement can be assumed when estimating the post-failure displacement demand. The new period may be estimated from the initial stiffness of the post-failure system as shown in Figure 31F-7-14. A new displacement demand can then be calculated in accordance with Section 3104F.2.

3107F.2.8.2 Non-ordinary Batter Piles. For the case of a plugged batter pile system, an appropriate displacement force relationship considering plug friction may be used in modeling the structural system.

For fused and seismic release mechanism batter pile systems, a nonlinear modeling procedure shall be used and peer reviewed (Section 3101F.6.1).

3107F.2.9 Concrete Pile Caps with Concrete Deck.

3107F.2.9.1 General. The moment-curvature and moment-rotation relationships shall be computed for pile caps using the methodology previously described. When the deck and the pile cap behave monolithically, an appropriate width of the deck may be included as part of the pile cap cross-section as per ACI-318 [7.5].

3107F.2.9.2 Plastic Hinge Length. The plastic hinge length L_P for existing pile caps may be taken as:

$$L_P = 0.5D_c \quad (7-34)$$

where D_c is the pile cap depth.

3107F.2.9.3 Ultimate Concrete and Steel Flexural Strains. The ultimate strain limits defined in Section 3107F.2.5.5 shall also apply to pile caps and deck.

All concrete shall be treated as unconfined concrete unless it can be demonstrated that adequate confinement steel is present.

3107F.2.9.4 Component Acceptance/Damage Criteria. For new pile caps and deck, Level 1 seismic performance shall utilize the design methods in ACI-318 [7.5]; Level 2 seismic performance shall be limited to the following strains:

- Deck/pile cap: $\epsilon_c \leq 0.005$
- Reinforcing steel tension strain: $\epsilon_s \leq 0.01$

For existing pile caps and deck, the limiting strain values are defined in Table 31F-7-5.

Concrete components for all nonseismic loading combinations shall be designed in accordance with ACI 318 [7.5].

3107F.2.9.5 Shear Capacity (Strength). Shear capacity shall be based on nominal material strengths; reduction factors shall be in accordance with ACI 318 [7.5].

3107F.2.10 Concrete Detailing. For new MOTs, the required development splice length, cover and detailing shall conform to ACI 318 [7.5], with the following exceptions:

1. For pile/deck dowels, the development length may be calculated in accordance with Section 3107F.2.7.2.
2. The minimum concrete cover for prestressed concrete piles shall be three inches, unless corrosion inhibitors are used, in which case a cover of two-and-one-half inches is acceptable.
3. The minimum concrete cover for wharf beams and slabs, and all concrete placed against soil shall be three inches, except for headed reinforcing bars (pile dowels or shear stirrups) the cover may be reduced to two-and-one-half inch cover at the top surface only. If corrosion inhibitors are used, a cover of two-and-one-half inches is acceptable.

3107F.3 Timber Piles and Deck Components.

3107F.3.1 Component Strength. The following parameters shall be established in order to assess component strength:

New and existing components:

1. Modulus of rupture
2. Modulus of elasticity
3. Type and grade of timber

Existing components only:

1. Original cross-section shape and physical dimensions
2. Location and dimension of braced frames
3. Current physical condition of members including visible deformation
4. Degradation may include environmental effects (e.g., decay, splitting, fire damage, biological and chemical attack) including its effect on the moment of inertia, I

5. Loading and displacement effects (e.g., overload, damage from earthquakes, crushing and twisting)

Section 3104F.2.2 discusses existing material properties. At a minimum, the type and grade of wood shall be established. The published stress values in the ANSI/AF&PA NDS [7.9] may be used as default values and shall be multiplied by a factor of 2.8 to convert from allowable stress levels to yield or ultimate values for seismic loading.

For deck components, the allowable stresses shall be limited to the values published in the ANSI/AF&PA NDS [7.9] increased by a factor of 2.0. Piling deformation limits shall be calculated based on the strain limits in accordance with Section 3107F.3.3.3.

The values shown in the ANSI/AF&PA NDS [7.9] are not developed specifically for MOTs and can be used as default properties only if as-built information is not available, the member is not damaged and testing is not performed. To account for the inherent uncertainty in establishing component capacities for existing structures with limited knowledge about the actual material properties, a reduction (knowledge) factor of $k = 0.75$ shall be included in the component strength and deformation capacity analyses in accordance with Section 3107F.2.1.2.

The modulus of elasticity shall be based on tests or the ANSI/AF&PA NDS [7.9]. Alternatively the values shown in Table 31F-7-7 may be used for typical timber piles:

**TABLE 31F-7-7
MODULUS OF ELASTICITY (E) FOR TYPICAL TIMBER PILES**

SPECIES	E (psi)
Pacific Coast Douglas Fir	1,500,000
Red Oak	1,250,000
Red Pine	1,280,000
Southern Pine	1,500,000

3107F.3.2 Deformation Capacity of Flexural Members. The displacement demand and capacity of existing timber structures may be established per Section 3104F.2.

The soil spring requirements for the lateral pile analysis shall be in accordance with Section 3106F.

A linear curvature distribution may be assumed along the full length of a timber pile.

The displacement capacity of a timber pile can then be established per Section 3107F.3.3.2.

3107F.3.3 Timber Piles.

3107F.3.3.1 Stability. Section 3107F.2.5.2 shall apply to timber piles.

3107F.3.3.2 Displacement Capacity. A distinction shall be made between a pier-type pile, with a long unsupported length and a wharf-landside-type pile with a short unsupported length between the deck and soil. The effective length, L , is the distance between the pinned deck/pile connection and in-ground fixity as shown in Figure 31F-7-15. For pier-type (long unsupported length) vertical piles, two simplified procedures to determine fixity or displacement capacity are described in MIL-HDBK-1025/6 [7.10] or the Navy Design Manual 7.02 [7.11], respectively.

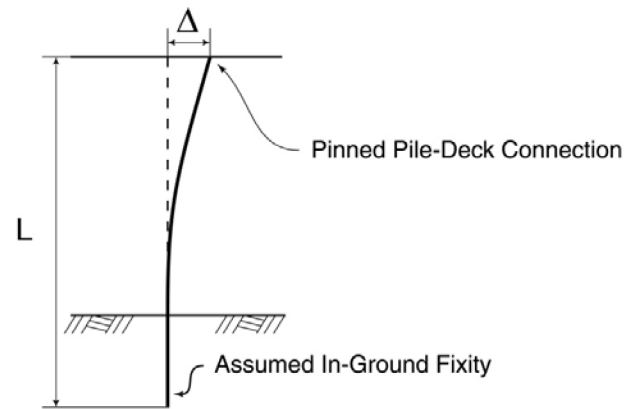

FIGURE 31F-7-15—ASSUMED IN-GROUND FIXITY

In order to determine fixity in soft soils, another alternative is to use Table 31F-7-8.

The displacement capacity, Δ , for a pile pinned at the top, with effective length, L , and moment, M , using Table 31F-7-8 or MIL-HDBK-1025/6 [7.10] is:

$$\Delta = \frac{ML^2}{3EI} \tag{7-35}$$

WHERE:

- E = Modulus of elasticity
- I = Moment of inertia

Assuming linear curvature distribution along the pile, the allowable curvature, ϕ_a , can be established from:

$$\phi_a = \frac{\epsilon_a}{c_u} \tag{7-36}$$

WHERE:

- ϵ_a = allowable strain limit according to Section 3107F.3.3.3
- c_u = distance to neutral axis which can be taken as $D_p/2$, where D_p is the diameter of the pile

The curvature is defined as:

$$\phi = \frac{M}{EI} \tag{7-37}$$

The maximum allowable moment therefore becomes:

$$M = \frac{2\epsilon_a EI}{D_p} \tag{7-38}$$

The displacement capacity is therefore given by:

$$\Delta = \frac{2\epsilon_a L^2}{3D_p} \tag{7-39}$$

**TABLE 31F-7-8
DISTANCE BELOW GROUND TO POINT OF FIXITY**

PILE EI_p	SOFT CLAYS	LOOSE GRANULAR & MEDIUM CLAYS
$< 10^{10}$ lb in ²	10 feet	8 feet
$> 10^{10}$ lb in ²	12 feet	10 feet

3107F.3.3.3 Component Acceptance/Damage Criteria. The following limiting strain values apply for each seismic performance level for existing structures:

**TABLE 31F-7-9
LIMITING STRAIN VALUES FOR TIMBER**

EARTHQUAKE LEVEL	MAX. TIMBER STRAIN
Level 1	0.004
Level 2	0.008

Alternatively, ANSI/AF&PA NDS [7.9] may be used.

Timber components for all nonseismic loading combinations shall be designed in accordance with ANSI/AF&PA NDS [7.9].

3107F.3.3.4 Shear Capacity. To account for material strength uncertainties, the maximum shear demand, $V_{max,push}$, established from the single pile lateral analysis shall be multiplied by 1.2:

$$V_{design} = 1.2V_{max,push} \quad (7-40)$$

The maximum shear stress τ_{max} , in a circular pile can then be determined:

$$\tau_{max} = \frac{10}{9} \frac{V_{max,push}}{\pi \cdot r^2} \quad (7-41)$$

WHERE:

r = radius of pile

For the seismic load combinations, the maximum allowable shear stress, $\tau_{capacity}$, is the design shear strength, τ_{design} , from the ANSI/AF&PA NDS [7.9] multiplied by a factor of 2.8.

$$\tau_{capacity} = 2.8\tau_{design} \quad (7-42)$$

The shear capacity must be greater than the maximum demand.

3107F.4 Mooring and Berthing Components. Mooring components include bits, bollards, cleats, pelican hooks, capstans, mooring dolphins and quick release hooks.

Berthing components include fender piles and fenders, which may be camels, fender panels, or wales.

Applicable safety factors to be applied to the demand are provided in Section 3103F.10.

3107F.4.1 Component Strength. The following parameters shall be established in order to calculate component strength:

New and existing components:

1. Yield and tensile strength of structural steel
2. Structural steel modulus of elasticity
3. Yield and tensile strength of bolts
4. Concrete infill compressive strength
5. Concrete infill modulus of elasticity

Additional parameters for existing components:

1. Condition of steel including corrosion
2. Effective cross-sectional areas
3. Condition of embedment material such as concrete slab or timber deck

3107F.4.2 Mooring and Berthing Component Demand. The maximum mooring line forces (demand) shall be established per Section 3105F. Multiple lines may be attached to the mooring component at varying horizontal and vertical angles. Mooring components shall therefore be checked for all the mooring analysis load cases. The maximum demand on breasting dolphins and fender piles shall be established according to Sections 3103F.6 and 3105F.

3107F.4.3 Capacity of Mooring and Berthing Components. The structural and connection capacity of mooring components bolted

to the deck shall be established in accordance with AISC [7.8], ACI-318 [7.5], ANSI/AF&PA NDS [7.9] as appropriate. The mooring component capacity may be governed by the strength of the deck material. Therefore, a check of the deck capacity to withstand mooring component loads shall be performed.

3107F.5 Symbols.

- A_e = Effective shear area
- A_g = Uncracked, gross section area
- A_h = Total area of transverse reinforcement, parallel to direction of applied shear cut by an inclined shear crack
- A_s = Area of reinforcing steel
- A_{sp} = Spiral or hoop cross section area
- c = Depth from extreme compression fiber to neutral axis at flexural strength
- c_o = Outside of steel pipe to center of hoop or spiral or concrete cover to center of hoop or spiral
- c_u = Value of neutral axis depth at ultimate strength of section
- D = Pile diameter
- D^* = Reference diameter of 6 ft
- d_b = Dowel bar diameter
- d_c = Depth from edge of concrete to center of reinforcement
- d_{bl} = Diameter of the longitudinal reinforcement
- D_c = Depth of pile cap
- D_p = Pile diameter or gross depth (in case of a rectangular pile with spiral confinement)
- e = Eccentricity of axial load
- ϵ_a = Allowable strain limit
- ϵ_{cm} = Max extreme fiber compression strain
- ϵ_{cu} = Ultimate concrete compressive strain
- ϵ_{sm} = Strain at peak stress of confining reinforcement
- ϵ_u = Ultimate steel strain
- E = Modulus of elasticity
- f'_c = Concrete compression strength
- f'_{cc} = Confined strength of concrete
- F_p = Prestress compression force in pile
- f_p = Yield strength of prestress strands
- f_y = Yield strength of steel
- f_{ye} = Design yield strength of longitudinal or dowel reinforcement (ksi)
- f_{yh} = Yield stress of confining steel
- f_{yh} = Yield strength of transverse or hoop reinforcement
- $f_{y,shell}$ = Yield strength of steel shell
- $f_{y,e,r}$ = Reduced dowel yield strength
- h = Width of pile in considered direction
- h_d = Deck depth
- H = Distance from ground to pile point of contraflexure
- I_c = Moment of inertia of uncracked section
- I_e = Effective moment of inertia
- I_g = Gross moment of inertia
- K = Subgrade modulus
- k = Factor dependent on the curvature ductility $\mu_\phi = \phi/\phi_s$, within the plastic hinge region
- k = Knowledge factor

L = The distance from the critical section of the plastic hinge to the point of contraflexure
 L_p = Plastic hinge length
 l_{dc} = Minimum development length
 l_d = Existing development length
 l_{dv} = Vertical development length
 M_c = Moment capacity of the connection
 $M_{c,r}$ = Moment capacity at plastic rotation
 M_n = Moment at secant stiffness
 M_p = Moment as determined from a pushover analysis at displacements corresponding to the damage control limit state
 M_y = Moment at first yield
 N = Pile axial compressive force
 N_u = External axial compression on pile including load due to earthquake action
 ρ_s = Effective volume ratio of confining steel
 ρ_t = Nominal principal tension
 r = Radius of circular pile
 s = Spacing of hoops or spiral along the pile axis
 t = Shell thickness
 Δ = Displacement
 Φ = 1.0 for existing structures, and 0.85 for new design
 θ = Angle of critical crack to the pile axis (taken as 30° for existing structures, and 35° for new design)
 θ_p = Plastic rotation
 α = Angle between line joining centers of flexural compression in the deck/pile and in-ground hinges, and the pile axis
 ϕ_a = Allowable curvature
 ϕ_m = Maximum curvature
 ϕ_p = Plastic curvature
 ϕ_u = Ultimate curvature
 ϕ'_u = Adjusted ultimate curvature
 ϕ_y = Yield curvature
 ϕ'_y = Adjusted yield curvature
 τ_{max} = Maximum shear stress
 V_c = Concrete shear strength
 v_j = Joint shear stress
 V_{design} = Design shear strength
 $V_{max,push}$ = Maximum shear demand

V_n = Nominal shear strength
 V_s = Transverse reinforcement shear capacity (strength)
 V_{shell} = Shear capacity for steel pipe

3107F.6 References.

- [7.1] M.J.N. Priestley, M.J.N. Seible, Frieder, Gian Michele Calvi, "Seismic Design and Retrofit of Bridges," 1996, New York.
- [7.2] Ferritto, J., Dickenson, S., Priestley N., Werner, S., Taylor, C., Burke D., Seelig W., and Kelly, S., 1999, "Seismic Criteria for California Marine Oil Terminals, Vol.1 and Vol.2," Technical Report TR-2103-SHR, Naval Facilities Engineering Service Center, Port Hueneme, CA.
- [7.3] Federal Emergency Management Agency, FEMA-356, Nov. 2000, "Prestandard and Commentary for the Seismic Rehabilitation of Buildings," Washington, D.C.
- [7.4] Blakeley, J.P., Park, R., "Prestressed Concrete Sections with Cyclic Flexure," Journal of the Structural Division, American Society of Civil Engineers, Vol. 99, No. ST8, August 1973, pp. 1717-1742, Reston, VA.
- [7.5] American Concrete Institute, ACI 318-02, 2002, "Building Code Requirements for Structural Concrete (318-02) and Commentary (318R-02)," Farmington Hills, Michigan.
- [7.6] Applied Technology Council, 1996, ATC-32, "Improved Seismic Design Criteria for California Bridges: Provisional Recommendations," Redwood City, CA,
- [7.7] Kowalski, M.J. and Priestley, M.J.N., "Shear Strength of Ductile Bridge Columns," Proc. 5th Caltrans Seismic Design Workshop, Sacramento, June 1998.
- [7.8] American Institute of Steel Construction (AISC), 2001, "Manual of Steel Construction, Load and Resistance Factor Design (LRFD)," 3rd Ed., Chicago, IL.
- [7.9] American Forest & Paper Association, 2001, "National Design Specification for Wood Construction," ANSI/AF&PA NDS-2001, Washington, D.C.
- [7.10] Department of Defense, 1988, MIL-HDBK-1025/6, "General Criteria for Waterfront Construction 1025/6," 15 May 1988, Washington, D.C.
- [7.11] Naval Facilities Engineering Command, 1986, "Foundations and Earth Structures," Design Manual 7.02, Alexandria, VA.

Authority: Sections 8755 and 8757, Public Resources Code.
 Reference: Sections 8750, 8751, 8755 and 8757, Public Resources Code.

Division 8

SECTION 3108F — FIRE PREVENTION, DETECTION AND SUPPRESSION

3108F.1 General. This section provides minimum standards for fire prevention, detection and suppression at MOTs. See Section 3101F.3 for definitions of “new” (N) and “existing” (E).

3108F.2 Hazard Assessment and Risk Analysis.

3108F.2.1 Fire Hazard Assessment and Risk Analysis (N/E). A fire hazard assessment and risk analysis shall be performed, considering the loss of commercial power, earthquake and other relevant events.

3108F.2.2 Fire Plan (N/E). A site-specific Fire Plan shall be prepared by a registered engineer or a competent fire protection professional. The plan shall consider the hazards and risks identified per Section 3108F.2.1 and shall include, but not be limited to, the elements of pre-fire planning as discussed in Section 9 of [8.1] and Chapter 3 of [8.2]. The Fire Plan shall include goals, resources, organization, strategy and tactics, including the following:

1. MOT characteristics (e.g., tanker/manifold, product pipelines, etc.)
2. Product types and fire scenarios
3. Possible collateral fire damage to adjacent facilities
4. Fire-fighting capabilities, including availability of water (flow rates and pressure), foam type and associated shelf life, proportioning equipment, and vehicular access [8.1, 8.3]
5. The selection of appropriate extinguishing agents [8.1, 8.2]
6. Calculation of water and foam capacities, as applicable, consistent with area coverage requirements [8.1]
7. Coordination of emergency efforts
8. Emergency escape routes [8.2, 8.3]
9. Requirements for fire drills, training of wharf personnel, and the use of nonfixed equipment
10. Life safety
11. Rescue for terminal and vessel personnel [8.1]
12. Cooling water for pipelines and valves exposed to the heat
13. Contingency planning when supplemental fire support is not available. Mutual aid agreements can apply to water and land based support
14. Consideration of adverse conditions, such as electrical power failure, steam failure, fire pump failure, an earthquake or other damage to the fire water system.

The audit team shall review and field verify the fire-fighting equipment locations and condition and may check its operability.

3108F.2.3 Cargo Liquid and Fire Hazard Classifications (N/E). The cargo liquid hazard classes are defined in Table 31F-8-1, as either High (H_C) or Low (L_C), depending on the flash point.

Fire hazard classifications (Low, Medium or High) are defined in Table 31F-8-2, and are based on the cargo liquid hazard class and the sum of all stored and flowing volumes, prior to the Emergency Shut Down System (ESD) stopping the flow of oil.

The stored volume is the sum of the H_C and L_C liquid hazard class piping volumes (V_{SH} and V_{SL}), if the piping is not stripped.

During a pipeline leak, a quantity of oil is assumed to spill at the maximum cargo flow rate until the ESD is fully effective. The ESD valve closure is required to be completed in 60 seconds if installed prior to November 1, 1980 or in 30 seconds if installed after that date (2 CCR 2380 (h) (3))[8.3]. The flowing volume is the sum of the H_C and L_C liquid hazard class volumes (V_{FH} and V_{FL}), and shall be calculated as follows:

$$V_F = Q_C \times \Delta t \times (1/3,600) \quad (8-1)$$

WHERE:

- V_F = Flowing Volume (V_{FH} or V_{FL}) [bbl]
- Q_C = Cargo Transfer Rate [bbl/hr]
- Δt = ESD time, 30 or 60 seconds

3108F.3 Fire Prevention.

3108F.3.1 Ignition Source Control.

3108F.3.1.1 Protection from ignition by static electricity, lightning or stray currents shall be in accordance with API RP 2003 [8.5](N/E).

3108F.3.1.2 Requirements to prevent electrical arcing shall be in conformity with 2 CCR 2341 [8.3] (N/E).

3108F.3.1.3 Multiberth terminal piers shall be constructed so as to provide a minimum of 100 ft between adjacent manifolds (N).

3108F.3.2 Emergency Shutdown Systems. An essential measure of fire prevention is communications in conjunction with the emergency shutdown. The ESD and isolation system shall conform to 2 CCR 2380 (h) [8.3] and 33 CFR 154.550 [8.6]. An ESD system shall include or provide:

1. An ESD valve, located near the dock manifold connection or loading arm (N/E).
2. ESD valves, with “Local” and “Remote” actuation capabilities (N).
3. Remote actuation stations strategically located, so that ESD valve(s) may be shut within required times (N).
4. Multiple actuation stations installed at strategic locations, so that one such station is located more than 100 feet from areas classified as Class I, Group D, Division 1 or 2 [8.7]. Actuation stations shall be wired in parallel to achieve redundancy and arranged so that fire damage to one station will not disable the ESD system (N).
5. Communications or control circuits to synchronize simultaneous closure of the Shore Isolation Valves (SIVs) with the shutdown of loading pumps (N).
6. A manual reset to restore the ESD system to an operational state after each initiation (N).
7. An alarm to indicate failure of the primary power source (N).
8. A secondary (emergency) power source (N).
9. Periodic testing of the system (N).
10. Fire proofing of motors and control-cables that are installed in areas classified as Class I, Group D, Division 1 or 2 [8.7]. Fire proofing shall, at a minimum, comply with the recommendations of API Publication 2218 (see Section 6 of [8.8]) (N).

TABLE 31F-8-1
CARGO LIQUID HAZARD CLASS

CLASS	CRITERION	REFERENCE	EXAMPLES
Low (L _c)	Flash Point ≥ 140 °F	ISGOTT (Chapter 15, [8.4]) — Nonvolatile	#6 Heavy Fuel Oil, residuals, bunker
High (H _c)	Flash Point < 140 °F	ISGOTT (Chapter 15, [8.4]) — Volatile	Gasoline, JP4, crude oils

TABLE 31F-8-2
FIRE HAZARD CLASSIFICATIONS

CLASS	STORED VOLUME (bbbl)			FLOWING VOLUME (bbbl)		CRITERIA (bbbls)*
	Stripped	V _{SL}	V _{SH}	V _{FL}	V _{FH}	
LOW	y	n	n	y	y	V _{FL} ≥ V _{FH} , and V _T ≤ 1200
LOW	n	y	n	y	n	V _{SL} + V _{FL} ≤ 1200
MEDIUM	n	n	y	n	y	V _{SH} + V _{FH} ≤ 1200
MEDIUM	y	n	n	y	y	V _{FH} > V _{FL} , and V _T ≤ 1200
HIGH	n	n	y	n	y	V _{SH} + V _{FH} > 1200
HIGH	y	n	n	y	y	V _T > 1200
HIGH	n	y	y	y	y	V _T > 1200
HIGH	n	y	n	y	n	V _{SL} + V _{FL} > 1200
HIGH	n	n	y	n	y	V _{SH} + V _{FH} > 1200

y = yes

n = no

Stripped = product purged from pipeline following product transfer event.

V_{SL} ≡ stored volume of low-hazard class product

V_{SH} ≡ stored volume of high-hazard class product

V_{FL} ≡ volume of low-hazard class product flowing through transfer line during 30 - 60 secs. ESD.

V_{FH} ≡ volume of high-hazard class product flowing through transfer line during 30 - 60 secs. ESD.

V_T ≡ V_{SL} + V_{SH} + V_{FL} + V_{FH} = Total Volume (stored and flowing)

* Quantities are based on maximum flow rate, including simultaneous transfers.

3108F.3.3 Shore Isolation Valves (SIV). Shore Isolation Valve(s) shall:

1. Be located onshore for each cargo pipeline. All SIVs shall be clustered together, for easy access (N).
2. Be clearly identified together with associated pipeline (N/E).
3. Have adequate lighting (N/E).
4. Be provided with communications or control circuits to synchronize simultaneous closure of the ESD system with the shut down of loading pumps (N).
5. Have a manual reset to restore the SIV system to an operational state after each shut down event (N).
6. Be provided with thermal expansion relief to accommodate expansion of the liquid when closed. Thermal relief piping shall be properly sized and routed around the SIV, into the downstream segment of the pipeline or into other containment (N/E).

SIVs installed in pipelines carrying hazard class, HC liquids, or at a MOT with a risk classification “Medium” or “High” (see Table 31F-4-1), shall be equipped with “Local” and “Remote” actuation capabilities. Local control SIVs may be motorized and/or operated manually (N).

3108F.4 Fire Detection. An MOT shall have a permanently installed automated fire detection or sensing system (N).

3108F.5 Fire Alarms. Automatic and manual fire alarms shall be provided at strategic locations. The fire alarm system shall be arranged to provide a visual and audible alarm that can be readily

discerned by all personnel at the MOT. Additionally, visual and audible alarms shall be displayed at the Facility’s Control Center (N/E).

If the fire alarm system is integrated with the ESD system, the operation shall be coordinated with the closure of SIVs, block valves and pumps to avoid adverse hydraulic conditions (N/E).

3108F.6 Fire Suppression. Table 31F-8-3 gives the minimum provisions for fire-water flow rates and fire extinguishers. The table includes consideration of the fire hazard classification (Low, Medium or High), the cargo liquid hazard class (Low or High) and the vessel or barge size. The minimum provisions may have to be augmented for multi-berth terminals or those conducting simultaneous transfers, in accordance with the risks identified in the Fire Plan.

3108F.6.1 Coverage (N/E). The fire suppression system shall provide coverage for:

1. Marine structures including the pier/wharf and approach trestle
2. Terminal cargo manifold
3. Cargo transfer system including loading arms, hoses and hose racks
4. Vessel manifold
5. Sumps
6. Pipelines
7. Control Stations

**TABLE 31F-8-3
MINIMUM FIRE SUPPRESSION PROVISIONS (N/E)**

FIRE HAZARD CLASSIFICATION (From Table 31F-8-2)	VESSEL AND CARGO LIQUID HAZARD CLASS (From Table 31F-8-1)	MINIMUM PROVISIONS
LOW	Barge with L _C (including drums)	500 gpm of water 2 x 20 lb portable dry chemical and 2 x 110 lb wheeled dry chemical extinguishers or the equivalent.
LOW	Barge with H _C (including drums) Tankers < 50 KDWT, handling L _C or H _C	1,500 gpm of water 2 x 20 lb portable dry chemical and 2 x 165 lb wheeled dry chemical extinguishers or the equivalent
MEDIUM	Tankers < 50 KDWT handling L _C	1,500 gpm of water 2 x 20 lb portable dry chemical and 2 x 165 lb wheeled dry chemical extinguishers or the equivalent.
MEDIUM	Tankers < 50 KDWT, handling H _C	2,000 gpm of water 4 x 20 lb portable dry chemical and 2 x 165 lb wheeled dry chemical extinguishers or the equivalent.
HIGH	Tankers < 50 KDWT, handling L _C or H _C	3,000 gpm of water 4 x 20 lb portable dry chemical and 2 x 165 lb wheeled dry chemical extinguishers or the equivalent.
LOW, MEDIUM, HIGH	Tankers > 50 KDWT, handling L _C or H _C	3,000 gpm of water 6 x 20 lb portable dry chemical and 4 x 110 lb wheeled dry chemical extinguishers or the equivalent.

Notes: L_C and H_C are defined in Table 31F-8-1. KDWT = Dead Weight Tons (Thousands)

3108F.6.2 Fire Hydrants. Hydrants shall be located not greater than 300 ft apart, along the wharf and approach trestle [Section 4.2.3 of API 2001 [8.1]]. Additional hose connections shall be provided at the base of fixed monitors and upstream of the water and foam isolation valves. Connections shall be accessible to fire trucks or mutual aid equipment as identified in the Fire Plan (N).

Hydrants and hoses shall be capable of applying two independent water streams covering the cargo manifold, transfer system, sumps and vessel manifold (N/E).

3108F.6.3 Fire Water. The source of fire water should be reliable and provide sufficient capacity as determined in the fire plan.

1. All wet systems shall be kept pressurized (jockey pump or other means) (N/E).

2. Wet system headers shall be equipped with a low-pressure alarm wired to the control room (N).

3. Fire pumps shall be installed at a distance of at least 100 ft from the nearest cargo manifold area (N).

4. Hose connections for fireboats or tugboats shall be provided on the MOT fire water line. Connections shall be installed at a safe access distance from the high-risk areas such as sump, manifold and loading arms (N/E).

3108F.6.4 Foam Supply (N/E). Product flammability, foam type, water flow rates and application duration shall be considered in foam supply calculations.

Fixed foam proportioning equipment shall be located at a distance of at least 100 ft from the high-risk areas such as sump, manifold and loading arms, except where hydraulic limits of the foam delivery system require closer proximity.

MOTs shall have a program to ensure that foam is replaced according to the manufacturer's recommendations.

3108F.6.5 Fire Monitor Systems. Fire monitors shall be located to provide coverage of MOT cargo manifolds, loading arms, hoses, and vessel manifold areas. This coverage shall provide at least two independent streams of water/foam. Monitors shall be located to provide an unobstructed path between the monitor and the target area (N/E).

If the vessel manifold is more than 30 ft above the wharf deck, the following factors shall be considered, in order to determine if monitors located on elevated masts or towers are required (N/E):

1. Maximum tanker freeboard
2. Tidal variations
3. Pier/wharf/loading platform elevation
4. Winds
5. Fire water line pressure

Sprinklers and/or remotely controlled water/foam monitors shall be installed to protect personnel, escape routes, shelter locations and the fire water system (N).

Isolation valves shall be installed in the fire water and the foam lines in order to segregate damaged sections without disabling the entire system. Readily accessible isolation valves shall be installed 100 - 150 ft from the manifold and the loading arm/hose area (N).

3108F.6.6 Supplemental Fire Suppression Systems (E). A supplemental system is an external waterborne or land-based source providing suppressant and equipment. Supplemental systems may not provide more than one-quarter of the total water requirements specified in the Fire Plan.

Additionally, supplementary systems shall not be considered in a Fire Plan, unless available within 20 minutes following the initiation of a fire alarm. Mutual aid may be considered as part of the supplemental system.

3108F.7 References.

[8.1] American Petroleum Institute, 1998, API Recommended Practice 2001 (API RP 2001), "Fire Protection in Refineries," 7th ed., Washington, D.C.

[8.2] Oil Companies International Marine Forum (OCIMF), 1987, "Guide on Marine Terminal Fire Protection and Emergency Evacuation," 1st ed., Witherby, London.

[8.3] 2 CCR 2300-2407 (Title 2, California Code of Regulations, Sections 2300-2407).

[8.4] International Chamber of Shipping (ICS), Oil Companies International Marine Forum (OCIMF), International Association of Ports and Harbors (IAPH), 1996, "International Safety Guide for Oil Tankers and Terminals (ISGOTT)," 4th ed., Witherby, London.

[8.5] American Petroleum Institute, 1998, API Recommended Practice 2003 (API RP 2003), "Protection Against Ignitions Arising Out of Static, Lightning, and Stray Currents," 6th ed., Washington, D.C.

Division 9

SECTION 3109F — PIPING AND PIPELINES

3109F.1 General. This section provides minimum engineering standards for piping, pipelines, valves, supports and related appurtenances at MOTs. This section applies to piping and pipelines used for transferring:

1. Oil (see Section 3101F.1) to or from tank vessels or barges
2. Oil within the MOT
3. Vapors, including Volatile Organic Compounds (VOCs)
4. Inerting or enriching gases to vapor control systems

Additionally, it also applies to piping or pipelines providing services, which includes stripping, sampling, venting, vapor control and fire water.

See Section 3101F.3 for definitions of “new” (N) and “existing” (E).

3109F.2 Oil Piping and Pipeline Systems. All pressure piping and pipelines for oil service shall conform to the provisions of API Standard 2610 [9.1], ASME B31.3 [9.2] or B31.4 [9.3] as appropriate, including the following:

1. All piping/pipelines shall be documented on current P&ID’s (N/E).
2. Piping and pipeline systems shall be installed above deck (N).
3. The systems shall be arranged in a way not to obstruct access to and removal of other piping components and equipment (N).
4. Flexibility shall be achieved through adequate expansion loops or joints (N/E).
5. A guide or lateral restraint shall be provided just past the elbow where a pipe changes direction in order to minimize excessive axial stress (N).
6. Piping shall be routed to allow for movement due to thermal expansion and seismic displacement, without exceeding the allowable stresses in the supports, and anchor connections (see Section 3109F.3) (N/E).
7. Plastic piping shall not be used unless designated for oil service (N/E).
8. If a flanged connection exists within 20 pipe diameters from the end of any replaced section, the pipe shall be replaced up to and including the flange.
9. Pipelines shall be seamless, electric-resistance-welded or electric-fusion-welded (N).
10. Piping greater than 2 inches in diameter shall be butt-welded. Piping 2 inches and smaller shall be socket welded or threaded.
11. Pipeline connections directly over the water shall be welded (N). Flanged connections not over water shall have secondary containment (N).
12. Pipelines that do not have a valid and certified Static Liquid Pressure Test (SLPT) [9.4] shall be marked “OUT OF SERVICE”. Out-of-service piping and pipelines shall be purged, gas-freed and physically isolated from sources of oil.
13. If a pipeline is “out-of-service” for 3 or more years, it will require Division approval prior to re-use.

3109F.3 Pipeline Stress Analysis (N/E). Pipeline stress analysis shall be performed for:

1. New piping and pipelines
2. Significant rerouting/relocation of existing piping
3. Any replacement of “not in-kind” piping
4. Any significant rearrangement or replacement of “not in-kind” anchors and/or supports
5. Significant seismic displacements calculated from the structural assessment

Piping stress analysis shall be performed in accordance with ASME B31.4 [9.3], considering all relevant loads and corresponding displacements determined from the structural analysis described in Section 3104F.

Flexibility analysis for piping, considering supports, shall be performed in accordance with ASME B31.4 [9.3] by using the largest temperature differential imposed by normal operation, start-up, shutdown or abnormal conditions. Thermal loads shall be based upon maximum and minimum local temperatures; heat traced piping shall use the maximum attainable temperature of the heat tracing system.

To determine forces at sliding surfaces, the coefficients of static friction shown in Table 31F-9-1 shall be used.

TABLE 3109F-9-1
COEFFICIENTS OF STATIC FRICTION

SLIDING SURFACE MATERIALS	COEFFICIENT OF STATIC FRICTION
Teflon on Teflon	0.10
Plastic on Steel	0.35
Steel on Steel	0.40
Steel on Concrete	0.45
Steel on Timber	0.49

3109F.4 Anchors and Supports. Anchors and supports shall conform to ASME B31.3 [9.2], ASME B31.4 [9.3], API Standard 2610 [9.1] and the ASCE Guidelines [9.5](N).

A seismic assessment shall be performed for existing anchors and supports using recommendations in Section 7 of CalARP [9.6] or Chapter 11 of FEMA 356 [9.7], as appropriate (E).

3109F.5 Appurtenances.

3109F.5.1 Valves and Fittings. Valves and fittings shall meet the following requirements:

1. Conform to ASME B 31.4 [9.3], API Standard 609 [9.8] and ASME B16.34 [9.9], as appropriate, based on their service (N).
2. Conform to Section 8 of [9.1] (N/E).
3. Stems shall be oriented in a way not to pose a hazard in operation or maintenance (N/E).
4. Nonductile iron, cast iron, and low-melting temperature metals shall not be used in any hydrocarbon service, fire water or foam service (N/E).
5. Double-block and bleed valves shall be used for manifold valves. (N/E).
6. Isolation valves shall be fire-safe, in accordance with API Standard 607 [9.10] (N).
7. Swing check valves shall not be installed in vertical down-flow piping (N/E).

8. Pressure relief devices shall be used in any closed piping system that has the possibility of being over pressurized due to temperature increase (thermal relief valves) or surging (N/E).

9. Pressure relief devices shall be sized in accordance with API RP 520 [9.11] (N). Set pressures and accumulating pressures shall be in accordance with [9.11] (N).

10. Discharge from pressure relief valves shall be directed into lower pressure piping for recycling or proper disposal. Discharge shall never be directed into the open environment, unless secondary containment is provided (N/E).

11. Threaded, socket-welded, flanged and welded fittings shall conform to Section 8 of [9.1] (N/E).

3109F.5.2 Valve Actuators (N/E).

1. Actuators shall have a readily accessible, manually operated overriding device to operate the valve during a power loss.

2. Torque switches shall be set to stop the motor closing operation at a specified torque setting.

3. Limit switches shall be set to stop the motor opening operation at a specified limit switch setting.

4. Critical valves shall be provided with thermal insulation. The insulation shall be inspected and maintained at periodic intervals. Records of thermal insulation inspections and condition shall be maintained for at least 6 years.

5. Electrical insulation for critical valves shall be measured for resistance following installation and retested periodically. These records shall be maintained for at least 6 years.

3109F.6 Utility and Auxiliary Piping Systems. Utility and auxiliary piping includes service for:

1. Stripping and sampling

2. Vapor control

3. Fire water and foam

4. Natural gas

5. Compressed air, venting and nitrogen

Stripping and sampling piping shall conform to Section 3109F.2 (N/E).

Vapor return lines and VOC vapor inerting and enriching (natural gas) piping shall conform to 33 CFR 154.808 [9.12] and API RP 1124 [9.13] (N).

Firewater and foam piping and fittings shall meet the following requirements:

1. Conform to ASME B 16.5 [9.14]

2. Fire mains shall be carbon steel pipe (N/E)

3. High density polyethylene (HDPE) piping may be used for buried pipelines (N/E)

4. Piping shall be color-coded (N/E)

Compressed air, venting and nitrogen piping and fittings shall conform to ASME B31.3 [9.2] (N).

3109F.7 References.

[9.1] American Petroleum Institute (API), 1994, API Standard 2610, "Design, Construction, Operation, Maintenance, and Inspection of Terminal and Tank Facilities," ANSI/API STD 2610-1994, 1st ed., Washington, D.C.

[9.2] American Society of Mechanical Engineers (ASME), 1998, ASME B31.3, "Process Piping," New York.

[9.3] American Society of Mechanical Engineers (ASME), 1998, ASME B31.4, "Pipeline Transportation Systems For Liquid Hydrocarbons And Other Liquids," New York.

[9.4] 2 CCR 2550 - 2556, 2560 - 2571 (Title 2, California Code of Regulations (CCR), Sections 2550-2556, 2560-2571).

[9.5] American Society of Civil Engineers, 1997, "Guidelines for Seismic Evaluation and Design of Petrochemical Facilities," New York.

[9.6] CalARP Program Seismic Guidance Committee, 1998, "Guidance for California Accidental Release Prevention (CalARP) Program Seismic Assessments", Sacramento, CA.

[9.7] Federal Emergency Management Agency, Nov. 2000, FEMA 356, "Prestandard and Commentary for the Seismic Rehabilitation of Buildings", Washington, D.C.

[9.8] American Petroleum Institute (API), 1997, API Standard 609, "Butterfly Valves: Double Flanged, Lug- and Wafer-Type," 5th ed., Washington, D.C.

[9.9] American Society of Mechanical Engineers (ASME), 1996, ASME B16.34, "Valves Flanged Threaded And Welding End," New York.

[9.10] American Petroleum Institute (API), 1996, API Standard 607, "Fire Test for Soft-Seated Quarter-Turn Valves," 4th ed., 1993 (reaffirmed 4/1996), Washington, D.C.

[9.11] American Petroleum Institute (API), 2000, API RP 520, "Sizing, Selection, and Installation of Pressure-relieving Devices in Refineries, Part I—Sizing and Selection, 7th ed., and Part II—Installation, 2003, 5th ed., Washington, D.C.

[9.12] 33 CFR 154.808 — Vapor Control Systems, General (Title 33, Code of Federal Regulations (CFR), Section 154.808).

[9.13] American Petroleum Institute (API), 1991, Recommended Practice 1124 (API RP 1124), "Ship, Barge, and Terminal Hydrocarbon Vapor Collection Manifolds," 1st ed., Washington, D.C.

[9.14] American Society of Mechanical Engineers (ASME), 1996, ASME B16.5, "Pipe Flanges and Flanged Fittings," New York.

Authority: Sections 8755 and 8757, Public Resources Code.

Reference: Sections 8750, 8751, 8755 and 8757, Public Resources Code.

Division 10

SECTION 3110F — MECHANICAL AND ELECTRICAL EQUIPMENT

3110F.1 General. This section provides the minimum standards for mechanical and electrical equipment at MOTs.

See Section 3101F.3 for definitions of “new” (N) and “existing” (E).

3110F.2 Marine Loading Arms.

3110F.2.1 General Criteria. Marine loading arms and ancillary systems shall conform to 2 CCR 2380 (b) [10.1], 33 CFR 154.510 [10.2] and the “Design and Construction Specification for Marine Loading Arms,” [10.3].

The following shall be considered when determining the loading arm maximum allowable extension limits:

1. Vessel sizes and manifold locations
2. Lowest-low water level (Datum)
3. Highest-high water level
4. Maximum vessel surge and sway
5. Maximum width of fendering system

3110F.2.2 Electrical and Hydraulic Power Systems.

3110F.2.2.1 Pressure and Control Systems (N).

1. Pressure gauges shall be mounted in accordance with ASME B40.100-1998 [10.4].

2. The hydraulic drive cylinders shall be mounted and meet either the mounting requirements of ANSI/(NFPA) T3.6.7 R2-1996 [10.5] or equivalent.

3. In high velocity current (> 1.5 knots) areas, all new marine loading arms shall be fitted with quick disconnect couplers and emergency quick release systems in conformance with Section 6.0 and 7.0 of [10.3]. In complying with this requirement, attention shall be paid to the commentary and guidelines in Part III of reference [10.3].

4. Out-of-limit, balance and the approach of out-of-limit alarms shall be located at or near the loading arm console.

3110F.2.2.2 Electrical Components (N). The following criteria shall be implemented:

1. Equipment shall be provided with a safety disconnecting device to isolate the entire electrical system from the electrical mains in accordance with Article 430 of the National Electric Code (NEC), [10.6].

2. Motor controllers and 3-pole motor overload protection shall be installed and sized in accordance with Article 430, NEC [10.6].

3. Control circuits shall be limited to 120 volts and shall comply with Articles 500 and 501 of the NEC [10.6]. Alternatively, intrinsically safe wiring and controls may be provided in accordance with Article 504, NEC [10.6] and ANSI/UL Std. No. 913 [10.7].

4. Grounding and bonding shall comply with the requirements of Article 430, NEC [10.6] and Section 3111F.

Section 3111F includes requirements for electrical equipment, wiring, cables, controls and electrical auxiliaries located in hazardous areas.

3110F.2.2.3 Remote Operation. The remote control system, where provided, shall conform to the recommendations of the OCIMF [10.3]. The remote operation shall be facilitated by either a pendant control system or by a hand-held radio controller (N).

The pendant control system shall be equipped with a plug-in capability to an active connector located either in the vicinity of the loading arms, or at the loading arm outboard end on the triple swivel, and hard-wired into the control console. The umbilical cord running from the triple swivel to the control console shall be attached to the loading arm. Other umbilical cords shall have sufficient length to reach the maximum operational limits (N).

The radio controller if installed shall comply with 2 CCR 2370(e) [10.8] and 47 CFR Part 15 [10.9] requirements for transmitters operating in an industrial environment (N/E).

3110F.3 Oil Transfer Hoses (N/E). Hoses for oil transfer service shall be in compliance with 2 CCR 2380 (a) [10.10] and 33 CFR 154.500 [10.11].

Hoses with diameters of 6 inches or larger shall have flanges that meet ANSI B16.5 [10.12]. Hoses with diameters of 4 inches or less may have quick disconnect fittings provided that they meet ASTM F-1122 [10.13].

3110F.4 Lifting Equipment: Winches And Cranes. Lifting equipment shall conform to [10.14], [10.15], [10.16] and [10.17]. Electrical equipment shall conform to the provisions of Section 3111F.

3110F.4.1 Winches.

1. Winches and ancillary equipment shall be suitable for a marine environment (N/E).

2. Winches shall be provided with a fail-safe braking system, capable of holding the load under all conditions, including a power failure (N/E).

3. Winches shall be fully reversible (N).

4. Shock, transient, and abnormal loads shall be considered when selecting winch systems (N).

5. Winches shall have limit switches and automatic trip devices to prevent over-travel of the drum in either direction. Limit switches shall be tested, and demonstrated to function correctly under operating conditions without inducing undue tensions or slack in the winch cables (N/E).

6. Under all operating conditions, there shall be at least two full turns of cable on grooved drums, and at least three full turns on ungrooved drums (N/E).

7. Moving winch parts which present caught-in hazards to personnel shall be guarded (N/E).

8. Winches shall have clearly identifiable and readily accessible stop controls (N/E).

3110F.4.2 Cranes (N/E).

1. Cranes shall not be loaded in excess of the manufacturer’s rating except during performance tests.

2. Drums on load-hoisting equipment shall be equipped with positive holding devices.

3. Under all operating conditions, there shall be at least two full turns of cable on grooved drums, and at least three full turns on ungrooved drums.

4. Braking equipment shall be capable of stopping, lowering, and holding a load of at least the full test load.

5. When not in use, crane booms shall be lowered to ground level or secured to a rest support against displacement by wind loads or other outside forces.

6. Safety systems including devices that affect the safe lifting and handling, such as interlocks, limit switches, load/moment and overload indicators with shutdown capability, emergency stop switches, radius and locking indicators, shall be provided [10.18].

3110F.5 Shore-To-Vessel Access for Personnel. This section applies to shore-to-vessel means of access for personnel and equipment provided by the terminal. This includes ancillary structures and equipment, which support, supplement, deploy and maneuver such vessel access systems.

Shore-to-vessel access for personnel shall conform to 29 CFR 1915.74 [10.19], Sections 19(b) and 21(b) of [10.20] and the following:

1. Shore-to-vessel access systems shall be designed to withstand the forces from dead, live, wind, vibration, impact loads, and the appropriate combination of these loads. The design shall consider all the critical positions of the system in the stored, maintenance, maneuvering, and deployed positions, where applicable (N).

2. The minimum live load shall be 50 psf on walkways and 25 plf with a 200 pounds minimum concentrated load in any location or direction on handrails (N).

3. The walkway shall be not less than 36 inches in width (N) and not less than 20 inches for existing walkways (E).

4. The shore-to-vessel access system shall be positioned so as to not interfere with the safe passage or evacuation of personnel (N/E).

5. Guardrails shall be provided on both sides of the access systems with a clearance between the inner most surfaces of the guardrails of not less than 36 inches and shall be maintained for the full length of the walkway (N).

6. Guardrails shall be at a height not less than 33 inches above the walkway surface and shall include an intermediate rail located midway between the walkway surface and the top rail (N/E).

7. The walkway surface, including self-leveling treads, if so equipped, shall be finished with a safe nonslip footing accommodating all operating gangway inclinations [10.21](N/E).

8. Under no circumstances shall the operating inclination of the walkway exceed 60 degrees from the horizontal or the maximum angle recommended by the manufacturer, whichever is less (N/E).

9. The undersides of aluminum gangways shall be protected with hard plastic or wooden strips to prevent being dragged or rubbed across any steel deck or component (N/E).

3110F.6 Sumps, Discharge Containment and Ancillary Equipment. Sumps, discharge containment and ancillary equipment shall conform to 2 CCR 2380(f) [10.22], 33 CFR 154.530 [10.23] and the following:

1. Sumps for oil drainage shall be equipped with pressure/vacuum vents, automatic draining pumps and shall be tightly covered (N/E).

2. Sumps which provide drainage for more than one berth should be equipped with liquid seals so that a fire on one berth does not spread via the sump (N/E).

3. Sumps shall be located at least 25 ft. from the manifolds, base of the loading arms or hose towers (N).

4. Conduct periodic integrity testing of the sump containers and periodic integrity and leak testing of the related valves and piping.

3110F.7 Vapor Control Systems. Vapor control systems shall conform to 33 CFR 154.800 through 154.850 [10.24] and API Standard 2610 [10.25]. The effects of seismic, wind, dead, live and other loads shall be considered in the analysis and design of individual tie-downs of components, such as of steel skirts, vessels, controls and detonation arresters. The analysis and design shall include the load transfer to supporting deck/pile structures or foundation elements.

3110F.8 Equipment Anchors and Supports. For new (N) electrical and mechanical equipment, the seismic lateral loads (demand) shall be calculated using the methods of Section 6.2 of FEMA 368 [10.26]. The design for load transfer to the wharf deck shall use the same procedures as for mooring and berthing components (see Section 3107F.4.3).

For existing (E) equipment, the seismic assessment shall be performed in accordance with CalARP [10.27], FEMA 356 [10.28] or ASCE Guidelines [10.29].

3110F.9 References.

- [10.1] 2 CCR 2380(b), Title 2, California Code of Regulations, Section 2380(b), Loading Arms.
- [10.2] 33 CFR 154.510, Title 33 Code of Federal Regulations Section 154.510.
- [10.3] Oil Companies International Marine Forum (OCIMF), 1999, "Design and Construction Specification for Marine Loading Arms," 3rd ed., Witherby, London.
- [10.4] American Society of Mechanical Engineers (ASME), 2000, ASME B40.100-1998, "Pressure Gauges and Gauge Attachments," New York.
- [10.5] National Fluid Power Association (NFPA), 1996, ANSI/(NFPA) T3.6.7 R2-1996, "Fluid Power Systems and Products — Square Head Industrial Cylinders — Mounting Dimensions," Milwaukee, WI.
- [10.6] National Fire Protection Association, 2002, NFPA 70, "National Electric Code," Quincy, MA.
- [10.7] Underwriters Laboratory, Inc., 1997, "Intrinsically Safe Apparatus and Associated Apparatus for Use in Class I, II, III, Division 1, Hazardous (Classified) Locations," ANSI/UL Standard No. 913, 5th ed., Northbrook, IL.
- [10.8] 2 CCR 2370(e), Title 2 California Code of Regulations, Section 2370(e).
- [10.9] 47 CFR Part 15 Private Land Mobile Radio Services, Title 47 Code of Federal Regulations (CFR).
- [10.10] 2 CCR 2380(a), Title 2, California Code of Regulations, Section 2380(a).
- [10.11] 33 CFR 154.500 Hose Assemblies, Title 33 Code of Federal Regulations Section 155.500.
- [10.12] American Society of Mechanical Engineers, 1996, ASME/ANSI B16.5, "Pipe Flanges and Flanged Fittings," New York.
- [10.13] American Society for Testing and Materials, 2001, ASTM F-1122-87 (1998), "Standard Specification for Quick Disconnect Couplings," West Conshohocken, PA.
- [10.14] 29 CFR 1918, Subpart F, Title 29 Code of Federal Regulations Section 1918, Subpart F.

Division 11

SECTION 3111F — ELECTRICAL SYSTEMS

3111F.1 General. This section provides minimum standards for electrical systems at marine oil terminals.

Electrical systems include the incoming electrical service and components, the electrical distribution system, branch circuit cables and the connections. Also included are:

1. Lighting, for operations, security and navigation
2. Controls for mechanical and electrical equipment
3. Supervision and instrumentation systems for mechanical and electrical equipment
4. Grounding and bonding
5. Corrosion protection through cathodic protection
6. Communications and data handling systems
7. Fire detection systems
8. Fire alarm systems
9. Emergency shutdown systems (ESD)

All electrical systems shall conform to API RP 540 [11.1] and the National Electrical Code (NEC) [11.2].

See Section 3101F.3 for definitions of “new” (N) and “existing” (E).

3111F.2 Hazardous area designations and plans (N/E). Area classifications shall be determined in accordance with API RP 500 [11.3], API RP 540 [11.1] and the NEC, Articles 500, 501, 504, 505, and 515 [11.2]. A marine oil terminal shall have a current set of scaled plan drawings, with clearly designated areas showing the hazard class, division and group. The plan view shall be supplemented with sections, elevations and details to clearly delineate the area classification at all elevations starting from low water level. The drawings shall be certified by a professional electrical engineer. The plans shall be reviewed, and revised when modifications to the structure, product or equipment change hazardous area identifications or boundaries.

3111F.3 Identification and Tagging. All electrical equipment, cables and conductors shall be clearly identified by means of tags, plates, color coding or other effective means to facilitate troubleshooting and improve safety, and shall conform to the identification carried out for the adjacent on-shore facilities (N). Topics for such identification are found in the NEC Articles 110, 200, 210, 230, 384, 480, and 504 [11.2]. Existing electrical equipment (E) shall be tagged.

Where identification is necessary for the proper and safe operation of the equipment, the marking shall be clearly visible and illuminated (N/E). A coded identification system shall apply to all circuits, carrying low or high voltage power, control, supervisory or communication (N).

3111F.4 Purged or Pressurized Equipment In Hazardous Locations (N/E). Purged or pressurized enclosures shall be capable of preventing the entry of combustible gases into such spaces, in accordance with NFPA 496 [11.4]. Special emphasis shall be placed on reliability and ease of operation. The pressurizing equipment shall be electrically monitored and alarms shall be provided to indicate failure of the pressurizing or purging systems.

3111F.5 Electrical Service. Where critical circuits are used for spill prevention, fire control or life safety, an alternative service derived from a separate source and conduit system, shall be located at a safe distance from the main power service. A separate feeder from a double-ended substation or other source backed up

by emergency generators will meet this requirement. An uninterruptible power service (UPS) shall be provided for control and supervisory circuits associated with ESD systems (N).

1. Electrical, instrument and control systems used to activate equipment needed to control a fire or mitigate its consequences shall be protected from fire and remain operable for 15 minutes in a 2000 °F fire, unless designed to fail-safe during fire exposure. The temperature around these critical components shall not exceed 200 °F during 15 minutes of fire exposure (N).

2. Wiring in fireproofed conduits shall be derated 15 percent to account for heat buildup during normal operation. Type MI (mineral insulated, metal sheathed [11.2]) cables may be used in lieu of fireproofing of wiring (N).

3. Emergency cables and conductors shall be located where they are protected from damage caused by traffic, corrosion or other sources (N).

4. Allowance shall be made for electrical faults, overvoltages and other abnormalities (N).

Where solid state motor controls are used for starting and speed control, corrective measures shall be incorporated for mitigating the possible generation of harmonic currents that may affect the ESD or other critical systems (N).

3111F.6 Grounding and Bonding (N/E).

1. All electrical equipment shall be effectively grounded as per NEC Article 250 [11.2]. All noncurrent carrying metallic equipment, structures, piping and other elements shall also be effectively grounded.

2. Grounding shall be considered in any active corrosion protection system for on-shore piping, submerged support structures or other systems. Insulation barriers, including flanges or non-conducting hoses shall be used to isolate cathodic protection systems from other electrical/static sources. None of these systems shall be compromised by grounding or bonding arrangements that may interconnect the corrosion protection systems or interfere with them in any way that would reduce their effectiveness.

3. Bonding of vessels to the MOT structure is not permitted (2 CCR 2341 (f)) [11.5].

4. Whenever flanges of pipelines with cathodic protection are to be opened for repair or other work, the flanges shall be bonded prior to separation.

5. Direct wiring to ground shall be provided from all towers, loading arms or other high structures that are susceptible to lightning surges or strikes.

3111F.7 Equipment Specifications (N). All electrical systems and components shall conform to National Electrical Manufacturer's Association (NEMA) standards or be certified by a Nationally Recognized Testing Laboratory (NRTL).

3111F.8 Illumination (N/E). Lighting shall conform to 2 CCR 2365 [11.6] and 33 CFR 154.570 (d) [11.7].

3111F.9 Communications and Control Systems.

3111F.9.1 Communication Systems (N/E). Communications systems shall comply with 2 CCR 2370 [11.8], and conform to Section 6 of [11.9].

3111F.9.2 Overfill Monitoring and Controls (N/E). Overfill protection systems shall conform to Appendix C of API RP 2350 [11.10]. These systems shall be tested before each transfer operation or monthly, whichever is less frequent. Where vessel or barge overfill sensors and alarms are provided, they shall comply with 33 CFR 154.812 [11.11].

All sumps shall be provided with level sensing devices to initiate an alarm to alert the operator at the approach of a high level condition. A second alarm shall be initiated at a high-high level to alert the operator. Unless gravity drainage is provided, sumps must have an automatic pump, programmed to start at a pre-determined safe level.

3111F.10 Corrosion Protection.

3111F.10.1 Corrosion Assessment (N/E). An assessment shall be performed to determine the existing and potential corrosion. This assessment should include all steel or metallic components, including the structure, pipelines, supports or other ancillary equipment, with drawings and specifications for corrosion prevention/protection. The assessment shall be performed by a licensed professional engineer, using the methods and criteria prescribed in [11.12].

3111F.10.2 Inspection, Testing and Records (N/E). For sacrificial anode systems, periodic underwater inspections shall be performed and observations recorded. For impressed current systems, monthly rectifier readings and annual potential readings of the protected components shall be taken. If potential readings for steel structures are outside of acceptable limits (between -0.85 [11.13] and -1.10 Volts), corrective actions shall be taken. Voltage drops other than across the structure-to-electrolyte boundary must be considered for valid interpretations of potential measurement. Consideration is understood to mean the application of sound engineering practice in determining the significance of voltage drops by methods such as:

1. Measuring or calculating voltage drop(s)
2. Reviewing historical performance of the Cathodic Protection System (CPS)
3. Evaluating the physical and electrical characteristics of the structure and the environment
4. Determining whether or not there is physical evidence of corrosion

All isolating sections shall be tested immediately after installation or replacement, and, at a minimum, annually. Test results shall be recorded and documented. Electrical tests on insulating flanges shall make use of specialized insulator testers. The test instrument shall make use of RF signals, capacitive measurements or other means to clearly determine whether an insulating flange is shorted or open circuited without being affected by pipe-to-soil potentials, cathodic protection voltages or whether it is buried or exposed.

The cathodic protection inspection for buried or submerged pipelines shall conform to API 570 [11.14].

Insulating and isolating arrangements for protection against static, stray and impressed currents shall be tested in accordance with 2 CCR 2341(d) and 2380 [11.15].

3111F.11 References.

- [11.1] American Petroleum Institute, 1999, API Recommended Practice 540 (API RP 540), "Electrical Instal-

lations in Petroleum Processing Plants," 4th ed., Washington, D.C.

- [11.2] National Fire Protection Association, 2002, NFPA 70, "National Electric Code (NEC)," Quincy, MA.
- [11.3] American Petroleum Institute, 1997, API Recommended Practice 500 (API RP 500), "Recommended Practice for Classification of Locations for Electrical Installations at Petroleum Facilities Classified as Class I, Division 1 and Division 2," 2nd ed., Washington, D.C.
- [11.4] National Fire Protection Association, 1998, NFPA 496, "Standard for Purged and Pressurized Enclosures for Electrical Equipment," Quincy, MA.
- [11.5] 2 CCR 2341(f), Title 2, California Code of regulations, Section 2341(f).
- [11.6] 2 CCR 2365, Title 2 California Code of Regulations, Section 2365.
- [11.7] 33 CFR 154.570(d), Title 33 Code of Federal Regulations Section 154.570(d).
- [11.8] 2 CCR 2370, Title 2 California Code of Regulations, Section 2370.
- [11.9] Oil Companies International Marine Forum (OCIMF), 1987, "Guide on Marine Terminal Fire Protection and Emergency Evacuation," 1st ed., Witherby, London.
- [11.10] American Petroleum Institute, 1996, API Recommended Practice 2350 (API RP 2350), "Overfill Protection for Storage Tanks," 2nd ed., Washington, D.C.
- [11.11] 33 CFR 154.812, Title 33, Code of Federal Regulations, Section 154.812 — Facility Requirements for Vessel Liquid Overfill Protection.
- [11.12] National Association of Corrosion Engineers (NACE), Standard Recommended Practice, 1994, RP0176-1994 "Corrosion Control of Steel Fixed Offshore Platforms Associated with Petroleum Production," Houston, TX.
- [11.13] Department of Defense, 31 January 1990, Military Handbook, "Electrical Engineering Cathodic Protection," MIL-HDBK-1004/10, Washington, D.C.
- [11.14] American Petroleum Institute, 2002, API 570, "Piping Inspection Code", 2nd ed., October 1998 (February 2000 Addendum 1), Washington, D.C.
- [11.15] 2 CCR 2341(d) and 2380, Title 2, California Code of Regulations, Sections 2341(d) and 2380.

Authority: Sections 8755 and 8757, Public Resources Code.
Reference: Sections 8750, 8751, 8755 and 8757, Public Resources Code.

Section 470A.2.3 – In item 7, revise “water closet” to “toilet”.

Section 470A.2.6 – In item 4, revise “water closet” to “toilet”.

Section 470A.2.7 – In item 4, revise “water closet” to “toilet”.

Section 470A.2.8 – In item 3, revise “water closets” to “toilets”.

Section 470A.2.9 – In item 1, after the word “inmate” add “;” and delete the words “exclusive of circulation corridors of 3 feet (914 mm) in width in front of cells/rooms;”; and in item 3 revise “water closets” to “toilets”.

Section 470A.2.10 – Insert a new paragraph 3 to read “The exercise area must contain or provide free access to a toilet, wash basin, and drinking fountain as provided in Section 470A.3.”

Section 470A.2.12 – revise the first sentence to read “There must be a minimum of one suitably equipped medical examination room in every facility which provides on-site health care.”; add items “4. Provide lockable storage for medical supplies.” and “5. Any room where medical procedures are provided must be equipped with hot and cold running water.”

Section 470A.2.15 – Delete heading and the entire section.

Section 470A.2.22 – Delete the last sentence.

Section 470A.2.25 – Revise to read “There must be a minimum of one suitably furnished interview room for confidential interviews in every facility which provides on-site health care. The interview room shall be designed in consultation with responsible custody staff and health care staff. Such an interview room shall:”

Section A3.1 – Revise the title to read “**Toilets/urinals.**”; delete the section language and its exception inserting 6 new items and a Note.

Section 470A.3.2 – Revise the first “**Wash Basins.**” To a bold title; omit the balance of the language and exception; insert 7 new items.

Section 470A.3.3 – Revise the first sentence to read “... single-occupancy cell, double occupancy cell, dormitory, temporary holding cell, temporary staging cell, and sobering cell and be accessible to the occupants of dayrooms and exercise areas.”; revise item 1 to replace both locations of “water outlet” with “drinking fountain bubbler”; delete item 2; renumber item 3 as item 2.

Section 470A.3.4 – add “NOTE: Shower areas shall provide modesty for inmates with staff being able to visually supervise.”.

Section 470A.3.5 – In all locations revise “beds/bunks” to “beds”.

Section 470A.3.9 – in the title delete “/shelves/clothes hooks”; and delete all but the first sentence.

Section 470A.3.10 – Replace the first sentence with “In temporary holding and temporary staging cells, seating must be securely fixed to the floor and/or wall.”

9. January 2, 2003 Supplement approved by the California Building Standards Commission on January 31, 2001, Filed with the Secretary of State on February 2, 2001, published January 1, 2003, and effective 180 days after publication – July 1, 2003:

Section 460A.1.7 – In item 3, revise “... a maximum of 144 ...” to read “... a minimum of 144 ...”.

Section 460A.1.8 – In item 3, revise “... a maximum of 144 ...” to read “... a minimum of 144 ...”.

Section 460A.1.11 – Replace item 1. language.

Section 460A.1.11 – In item 1.1, revise “... one half ...” to read “... one quarter ...”.

Section 460A.1.11 – Revise item 1.2 to read “The required recreation area shall contain no single dimension less than 40 feet.”

Section 460A.1.12 – Revise to read “**Academic Classrooms.** There shall be dedicated academic classroom space for every juvenile in every facility. The primary purpose for the academic classroom shall be for education. Each academic classroom shall contain ...”; and, add the NOTE words as the last sentence of this section.

Section 460A.1.14 – delete the “and,” for the end of item 4; and, delete the “.” and add “; and,” to the end of item 5; and, insert a new item “6. Smooth, non porous, washable surfaces.”

Section 460A.2.1 – Revise the NOTE of item 3 to read “... provide modesty for ...”.

Section 460A.2.3 – insert new items 1. and 2.

Section 460A.2.5 – Delete the last “.” And add new language “... measured from any side of the bed. Beds placed”.

Section 470A.1 – Under **Living Areas**, revise “... as detoxification safety ...” to read “... as sobering safety ...”.

Section 470A.2.1 – In item 3., revise “A detoxification cell ...” to read “A sobering cell ...”; and, at the end, add “For those facilities that accept male and female intoxicated inmates, two sobering cells shall be provided.”

Section 470A.2.1 – Revise item 4. to read “Access to a shower within the secure portion of the facility.”

Section 470A.2.1 – Add a new item “8. Unobstructed access to hot and cold running water for staff use.”

Section 470A.2.4 – Revise it to read “**Sobering cell.** A sobering cell shall.”; and, add a new item “8. Have accessible a shower in the secure portion of the facility.”

Section 470A.2.5 – In item 1 revise the second line to read “... with no one floor dimension being less than 6 feet ...”; and, add a new item “8. any wall or ceiling mounted devices must be inaccessible to the inmate occupant.”

Section 470A.2.8 – In item 1 revise the second line to read “... single-bed unit; a minimum of 70 square ...”; and, revise the third line to read “... double-bed unit; and a minimum of 90 square feet for a triple-bed unit and have a minimum ...”.

Section 470A.2.9 – At the end of item 2. delete the “.” And add the words “allowed access at a given time;”

Section 470A.2.14 – Add a new second paragraph to read “If negative pressure isolation rooms are being planned, they shall be designed to recognized industry standards.”

Section 470A.2.16 – Revise the language in the third to the end of the section to read “... to purchase items. When commissary supplies are kept within the security perimeter for a facility, an area shall be provided for the secure storage of the stock for such inmate canteen items.”

Section 470A.2.20 – Revise the second line to read “... janitor’s closet, with sufficient area ...”; and, revise the third line to read “... cleaning implements and supplies, must be ...”; and revise the fourth line to read “... of the facility. A mop sink shall also be available within the security area of the facility. In court holding, ...”

Section 470A.3.5 – Revise the first line to read “... must be elevated off the floor, have a solid bottom, and a sleeping surface of at least ...”; and in the second and third lines, end the sentence at “long.” delete the words “and be of the pan-bottom type or constructed of concrete.”

Section 470A.3.8 – Revise “In detoxification cells ...” to read “In sobering cells ...”.

10. (OSHPD EF 01/02) Amend Chapters 4 and 10 of Part 2, Title 24. Approved as emergency by the California Building Stan-

dards Commission on January 15, 2003 and filed with the Secretary of State on January 16, 2003. Effective January 16, 2003.

11. Errata February 1, 2003:

Page 1-30: In Division 6 Occupancies, add reference to Appendix Chapter 3A.

Page 1-116, In Section 1004.3.4.3, insert [For SFM] and revise “. . . or more in Group E shall . . .” to “or more; and Group E shall . . .”

Page 1-134.82: In Figure 11B-18A, revise both parking stall widths to 9'-0" and the crosshatched divider to 5'-0".

Page 1-134.83: In both Figures 11B-18B and 11B-18C, revise parking stall width to 9'-0".

12. (SFM 3/02) Swing of Patient Room Doors. Amend Section 1007.511. Approved by the Building Standards Commission on May 14, 2003 and effective 180 days after publication.

13. (BOC 01/02) Design Criteria for Furnishings and Equipment. Adopt Section 460A.2.10 Design Criteria for Required Spaces. Amend Sections 460A.1.2; 460A.1.5-460A.1.9; 460A.1.13. Approved by the Building Standards Commission on July 16, 2003 and effective 180 days after publication.

14. (SFM EF 06/03) Senate Bill 1896 Bedridden Clients in Residential Care Facilities—Repealed emergency expired January 8, 2004.

15. (SFM EF 01/04) Senate Bill 1896 Bedridden Clients in Residential Care Facilities. Amend various sections of the California Building and Fire Codes. Approved on an emergency basis by the California Building Standards Commission on November 18, 2004, effective November 22, 2004.

16. Errata April 8, 2005 to November 22, 2004 Emergency Supplement:

Page 1-50.12A: Delete Table 8-B erroneously located in Chapter 4A.

Page 1-92: Insert requirements for R2 Occupancies into Table 8-B, renumber Footnote 7 to 8, and insert new Footnote 7.

17. (SFM EF 01/04) Senate Bill 1896 Bedridden Clients in Residential Care Facilities. Amend Sections 107.17.14; 203-B; 310.1; add new Section 415A; amend Table 8-A; Sections 904.2.10 and 1003.3.1.8.1. Approved as permanent by the Building Standards Commission on March 16, 2005.

18. (CSLCEF 2/05) Amend Title 24, Part 2 with the addition of Chapter 31F. Various sections. Approved by the California Building Standards Commission on January 19, 2005 and filed with the Secretary of State on January 31, 2005. Effective 180 days after publication.