

# Guidelines for Residential Rainwater Harvesting Systems Handbook





## CMHC—HOME TO CANADIANS

Canada Mortgage and Housing Corporation (CMHC) has been Canada's national housing agency for more than 65 years.

Together with other housing stakeholders, we help ensure that the Canadian housing system remains one of the best in the world. We are committed to helping Canadians access a wide choice of quality, environmentally sustainable and affordable housing solutions that will continue to create vibrant and healthy communities and cities across the country.

For more information, visit our website at [www.cmhc.ca](http://www.cmhc.ca)

You can also reach us by phone at 1-800-668-2642 or by fax at 1-800-245-9274.

Outside Canada call 613-748-2003 or fax to 613-748-2016.

Canada Mortgage and Housing Corporation supports the Government of Canada policy on access to information for people with disabilities. If you wish to obtain this publication in alternative formats, call 1-800-668-2642.

# Guidelines for Residential Rainwater Harvesting Systems Handbook

The federal government, through the National Research Council and the Canadian Commission on Building and Fire Codes, produces the model National Building Code and the model National Plumbing Code. This guideline document provides guidance for designing, constructing and managing rainwater harvesting systems based on the minimum safety requirements established in these model national codes.

The requirements of the model national codes have no force unless they are adopted by a provincial or territorial government. In some cases, provinces and territories either partially or wholly adopt these model codes as regulations in their jurisdictions. Alternatively, they can choose to have their own codes and seek to harmonize as much as possible with the model codes and the codes of other provinces and territories. In all cases, however, the applicable rainwater harvesting requirements are those set or referred to by the province or territory.

The Author and Editors do not assume responsibility for errors or oversights resulting from the information contained herein. Users must consult with the jurisdiction having authority concerning the design and installation of any of the products, components or systems described in this guide.

The information in this publication is a result of current research and knowledge. Readers should evaluate the information, materials and techniques cautiously for themselves and consult appropriate professional resources to see whether the information, materials and techniques apply to them. The images and text are guides only. Project and site-specific factors (climate, cost, aesthetics) must also be considered.

## Canadian Cataloguing in Publication Data

*Guidelines for Residential Rainwater Harvesting Systems, Handbook*

Issued also in French under the title:

*Manuel de lignes directrices sur les installations résidentielles de collecte de l'eau de pluie*

Library and Archives Canada Cataloguing in Publication

Guidelines for residential rainwater harvesting systems [electronic resource] : handbook.

Electronic monograph in PDF format.

Issued also in French under title: Lignes directrices sur les installations résidentielles de collecte de l'eau de pluie.

Issued also in printed form.

ISBN 978-1-100-21183-1

Cat. no.: NH15-471/2012E-PDF

I. Water harvesting--Equipment and supplies--Design and construction--Standards--Canada. I. Canada Mortgage and Housing Corporation

TH2493 G84 2012

628.1'3

C2012-980156-9

© 2012

All rights reserved. No part of this book may be used or reproduced in any form or by any means, without prior written permission of the Author or Editors.

**First Edition, September 2012**

## ACKNOWLEDGEMENTS

### *Rainwater Harvesting Task Group*

The Guidelines for Residential Rainwater Harvesting Systems were developed with assistance from a Rainwater Harvesting Task Group made up of government and industry stakeholders. Task Group members represent the following stakeholder groups:

- Alberta Municipal Affairs
- Canada Mortgage and Housing Corporation
- Canadian Water and Wastewater Association
- City of Calgary
- City of Guelph
- Ecoshift
- Evolve Builders Group Inc.
- GE Water and Process Technologies
- Interpump Supply Ltd.
- Ontario Ministry of Municipal Affairs and Housing
- Region of Durham
- RH<sub>2</sub>O North America Inc.
- Toronto and Region Conservation Authority

### *Task Group Members*

Tyler Wightman	Liliana Bozic	Peter Follett
Alf Durnie	Wayne Galliher	Shane Gallagher
Sidney Manning	David Auliffe	Danny Hui
Pierre McDonald	Geoff Jones	Glen Pleasance
Cate Soroczan	Ben Polley	Scott Robinson
T. Duncan Ellison	Mark Myronyk	Tim Van Seters

### *Author*

Christopher Despins, M.Sc., P. Eng.  
President  
Connect the Drops  
cdespins@connectthedrops.ca

### *Editors*

Chantelle Leidl, M.Sc.  
Rainwater Harvesting Specialist

Khosrow Farahbakhsh, Ph.D., P. Eng.  
Associate Professor  
University of Guelph  
khosrowf@uoguelph.ca

## TABLE OF CONTENTS

<b>Introduction</b> .....	<b>vii</b>
What are the Permitted Uses of Rainwater? .....	viii
<b>Chapter 1 Rainwater catchment and conveyance</b> .....	<b>1</b>
1.1 Introduction .....	2
1.2 Applicable codes, standards, and guidelines .....	3
1.3 Issues for consideration .....	4
Catchment area.....	4
Catchment material.....	5
Rainwater conveyance.....	6
Size, slope and placement of conveyance network.....	7
Site conditions and tank location .....	7
Conveyance network materials selection .....	8
Cold weather issues.....	8
Rainwater quality.....	8
1.4 Design and installation guidelines.....	9
1.5 Management guidelines.....	14
<b>Chapter 2 Rainwater storage and tank sizing</b> .....	<b>15</b>
2.1 Introduction .....	16
2.2 Applicable codes, standards, and guidelines .....	17
2.3 Issues for consideration .....	18
General .....	18
Tank location .....	18
Tank placement.....	19
Tank capacity .....	19
Cold weather issues.....	20
Tank material.....	21
2.4 Design and installation guidelines.....	21
2.5 Management guidelines.....	25
<b>Chapter 3 Rainwater quality and treatment</b> .....	<b>27</b>
3.1 Introduction .....	28
3.2 Applicable codes, standards, and guidelines .....	29

3.3 Issues for consideration .....	30
Rainwater quality and treatment Guidelines .....	30
Factors affecting rainwater quality .....	30
Treatment options .....	31
Treatment device selection.....	35
Performance issues with treatment devices.....	35
3.4 Design and installation guidelines.....	37
3.5 Management guidelines.....	41
<b>Chapter 4 Make-up water system and backflow prevention .....</b>	<b>43</b>
4.1 Introduction .....	44
4.2 Applicable codes, standards, and guidelines .....	45
4.3 Issues for consideration .....	47
Types of make-up water systems.....	47
Control equipment.....	49
Cross-connections, backflow prevention and premise isolation .....	51
Air gap .....	52
4.4 Design and installation guidelines.....	53
4.5 Management guidelines.....	57
<b>Chapter 5 Pump and pressurized distribution system .....</b>	<b>59</b>
5.1 Introduction .....	60
5.2 Applicable codes, standards, and guidelines .....	61
5.3 Issues for consideration .....	63
General .....	63
Pump.....	64
Pipes.....	68
Pressure Tank .....	69
5.4 Design and installation guidelines.....	70
5.5 Management guidelines.....	74
<b>Chapter 6 Overflow provisions and stormwater management .....</b>	<b>77</b>
6.1 Introduction .....	78
6.2 Applicable codes, standards, and guidelines .....	79

6.3 Issues for consideration .....	80
Overflow discharge locations.....	80
Selecting the most appropriate overflow discharge location .....	83
Soakaway pits .....	84
Rainwater quality .....	85
Rainwater harvesting as part of a stormwater management system.....	86
6.4 Design and installation guidelines.....	87
6.5 Management guidelines.....	89
<b>Appendices .....</b>	<b>91</b>
Appendix A Rainwater catchment and conveyance.....	93
Collection losses from roof surfaces.....	93
Sizing gutters and downspouts.....	93
Sizing rainwater conveyance drainage piping.....	97
Frost penetration depth and pipe freeze protection.....	100
Appendix B Rainwater storage and tank sizing .....	105
Rainwater harvesting design tool.....	105
Rainwater storage tank sizing tables.....	105
Appendix C Pump and pressurized distribution system.....	113
Calculation of required pump capacity.....	113
Calculation of required pressure from pump (pump head).....	114
Calculation of friction loss.....	115
Calculation of pressure tank size.....	117
Calculation of pipe size.....	118
Appendix D Overflow provisions and stormwater management.....	121
Utilizing a rainwater storage tank for retention and detention for stormwater management purposes.....	121
Design and sizing of soakaway pits.....	124

# Introduction

Rainwater harvesting (RWH) is the ancient practice of collecting rainwater and storing it for later use. RWH systems are composed of a roof catchment, a conveyance network, a rainwater storage tank, a pump and fixtures where rainwater is utilized. Most systems also incorporate treatment technologies to improve the quality of rainwater before and/or after storage, and include provisions for periods of insufficient rainfall (a make-up water supply) and periods of excessive rainfall (overflow provisions).

The most important considerations when designing and installing a RWH system are the pertinent provincial codes and regulations, standards and municipal bylaws. Other considerations include how the design, installation and management of RWH systems can affect the quantity of water saved and the quality of rainwater harvested, as well as the cold weather suitability of the system.

The design and installation guidelines are presented in several sections, organized by the different components of RWH systems. These components are as follows:

- Rainwater catchment and conveyance
- Rainwater storage and tank sizing
- Rainwater quality and treatment
- Make-up water system and backflow prevention
- Pump and pressurized distribution system
- Overflow provisions and stormwater management

This document is aimed at a wide audience, including homeowners, engineers, architects, contractors, developers, regulators, as well as members from municipal, provincial and federal levels of government. Background information on each aspect of a RWH system is discussed, and relevant clauses from existing codes and regulations, standards and guidelines are presented, as well as additional design criteria derived from recent field experience and international best practices for rainwater harvesting.



## WHAT ARE THE PERMITTED USES OF RAINWATER?

At the time of publication of these Guidelines (October 2011), the *2010 National Plumbing Code* (NPC) did permit the use of rainwater for flushing toilets and urinals as well as for directly connected underground irrigation systems that dispense water below the surface of the ground.

It is important to note, however, that the provisions of the 2010 NPC have no force unless adopted by the applicable province or territory. Given that the previous edition of the NPC (the 2005 edition) does not specify any permitted uses of rainwater, it is important to consult local authorities to determine whether the NPC has been partially or wholly adopted within the province or territory, and if so, which edition of the NPC (the 2005 or 2010 edition) is currently in force. In all cases, the applicable rainwater harvesting requirements are those set or referred to by the province or territory.

The background of the top section of the slide is a close-up photograph of water with numerous ripples, creating a textured, blue and white pattern. The ripples are concentric circles of varying sizes, suggesting raindrops hitting a surface.

# Chapter I

## Rainwater catchment and conveyance

## I.1 INTRODUCTION

A key component of rainwater harvesting is collecting rainwater from a catchment surface and conveying it to a tank for storage and future use.

Rainwater harvesting (RWH) systems most often utilize the roof of a house or building for collecting rainwater. While it is possible to collect rainwater from other surfaces such as lawns and parking lots, these catchments are not addressed in this manual due to concerns surrounding the quality of rainwater collected from these surfaces. Consequently, this chapter focuses exclusively on the collection of runoff from roof surfaces, or 'roof catchments.'

Once rainwater has been collected from the catchment surface, it must be conveyed to the storage tank by means of a 'conveyance network.' The most common method of conveying rainwater is through the use of gravity flow, whereby rainwater is transported to the storage tank without the use of pumps or other means of assistance. The conveyance network of an RWH system typically consists of three main components: external gutters (also referred to as 'eavestroughs'), downspouts and drainage piping (shown in figure I-1). Other means of conveying rainwater, such as 'rain leaders' (drainage pipes located inside a building), are available; however, these will not be directly addressed.



**Figure I-1** Left 1. Gutter and 2. Downspout; Right Conveyance drainage piping for below-ground rainwater storage tank (prior to burial)

The size and complexity of a conveyance network may be quite minimal, as is the case for most above-ground storage tanks located a short distance from the catchment surface. For below-ground tanks and tanks integrated into buildings, these networks can be much more extensive and complex. This chapter provides guidance on the issues to consider when selecting the catchment surface, and how to design and install the conveyance network to handle the large volumes of rainwater runoff that are generated during severe storm events.

## I.2 APPLICABLE CODES, STANDARDS AND GUIDELINES

Table I-1 references codes and standards applicable to catchment and conveyance networks

**Table I-1** Applicable standards, codes and guidelines for rainwater catchment and conveyance networks.

Applicable codes, standards and guidelines	Selected provisions and design and installation implications
<i>National Building Code of Canada</i> (2010) and (2005)	<ul style="list-style-type: none"> <li>■ <b>Division B, Appendix C – table C-2. Design Data for Selected Locations</b></li> </ul> <p>Provides rainfall values, which are used for sizing rainwater conveyance drainage pipes as per articles 2.4.10.4. and 2.4.10.9. of the <i>National Plumbing Code</i>.</p>
<i>National Plumbing Code of Canada</i> (2010) and (2005)	<ul style="list-style-type: none"> <li>■ <b>2.2.5.10. Plastic Pipe, Fittings and Solvent Cement Used Underground</b></li> <li>■ <b>2.2.5.12. Plastic Pipe, Fittings and Solvent Cement Used in Buildings</b></li> <li>■ <b>2.3.4.5. Support for Horizontal Piping</b></li> <li>■ <b>2.3.4.6. Support for Underground Horizontal Piping</b></li> <li>■ <b>2.3.5.1. Backfill of Pipe Trench</b></li> <li>■ <b>2.3.5.4. Protection from Frost</b></li> <li>■ <b>2.4.7. Cleanouts</b></li> <li>■ <b>2.4.10.4. Hydraulic Loads from Roofs or Paved Surfaces</b></li> <li>■ <b>2.4.10.9. Hydraulic Loads on Storm or Combined Building Drains or Sewers</b></li> </ul> <p>Articles 2.2.5.10. and 2.2.5.12. specify approved pipe materials used underground and inside buildings. The NPC also provides provisions for the support and protection of piping.</p> <p>Subsection 2.4.7. provides provisions on the size and spacing of cleanouts, manholes, and location of cleanouts.</p> <p>Articles 2.4.10.4. and 2.4.10.9. specify the method for sizing conveyance drainage pipes, based on design rainfall intensity values (15 min rainfall, mm) obtained from table C-2 in the <i>National Building Code</i>, the roof catchment area and the slope of conveyance drainage piping.</p>
<b>CSA Standard B128.1</b> (2006)	<ul style="list-style-type: none"> <li>■ <b>10 Separation</b></li> <li>■ <b>12.3 Buried pipe (markings)</b></li> </ul> <p>Provides specifications for the installation of conveyance drainage piping for underground and above-ground applications.</p>
<b>NSF Protocol P151</b> (1995)	<p>Selection of roofing materials, coatings, paints and gutters with NSF P151 certification will not impart levels of contaminants greater than those specified in the U.S. EPA's Drinking Water Regulations. Recommended where high quality rainwater is needed for the intended use</p>

Mandatory documents

Supplementary documents

### I.3 ISSUES FOR CONSIDERATION

#### Catchment area

Theoretically, for every square metre of roof catchment area, 1 litre of rainwater can be captured per millimetre of rainfall. To calculate the catchment area:

$$\text{Catchment area (m}^2\text{)} = \text{Length (m)} \times \text{Width (m)}$$

The relationship between the catchment area and the volume of rainwater collected is illustrated in figure 1-2. As shown below, the larger the catchment area, the greater the quantities of rainwater that can be collected per millimetre of rainfall.

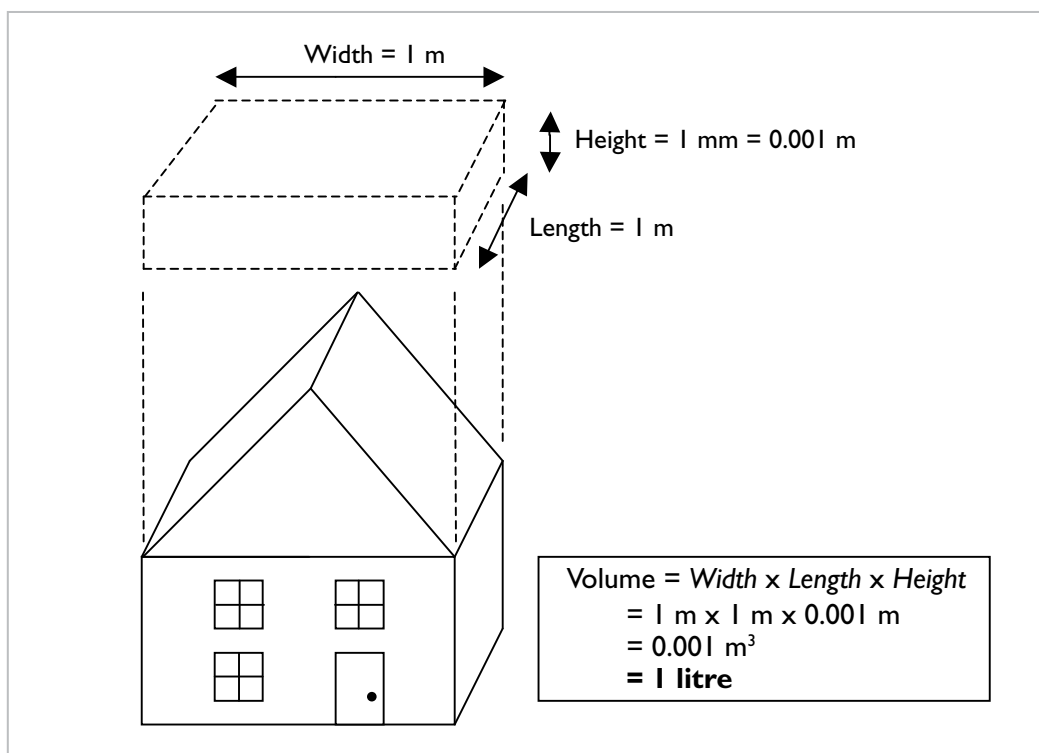

**Figure I-2** Theoretical volume of rainwater collected from a roof catchment

The catchment area has a significant impact on both the design and water savings potential of RWH systems. In general, it is recommended that the size of the catchment area used for an RWH system be as large as possible to maximize water savings. For most RWH systems collecting rainwater from a roof catchment, the size of the catchment area is usually predetermined by the size of the existing house or building. In such cases, one means of collecting additional rainwater is to utilize multiple roof catchments and convey rainwater to one central or 'communal' storage tank.

Alternatively, it may sometimes not be feasible or beneficial to collect rainwater from the entire catchment area due to rainwater quality concerns, location/placement of rainwater storage tank or for other reasons. These and other issues are discussed further in the *Design and installation guidelines*.

## Catchment material

In Canada, most houses have sloped roofs covered with asphalt shingles, while many industrial, commercial and institutional buildings have flat built-up roofs (which can be composed of various materials—for example, felt and asphalt roofs). The type of catchment material used by an RWH can affect:

- the proportion of rainfall collected during a rainfall event, defined as the 'collection efficiency' from the roof catchment;
- the quality of harvested rainwater.

### Rainfall collection efficiency

Although 1 litre of runoff can theoretically be collected from each millimetre of rainfall contacting a 1-m<sup>2</sup> surface area, some losses occur following contact with the catchment surface. These losses vary depending on the type of catchment material and the geometry of the roof, and should be considered when estimating the amount of rainwater that can be collected and utilized by the RWH system. In general, these losses can be characterized by an initial loss factor (in mm of rainfall) due to the absorbency of the catchment material, and continuous losses (in percentage of rainfall) from wind and leaks in the conveyance network. The losses for various roof catchment materials are listed in table I-2.

**Table I-2** Collection efficiency (loss factors) associated with various roof catchments<sup>1,2</sup>

Roof catchment material	Initial rainfall loss factor (mm)	Continuous rainfall loss ratio (%)
<b>Steel roof</b>	0.25	20.0
<b>Asphalt shingle roof</b>	0.5	20.0
<b>Fiberglass roof</b>	0.5	20.0
<b>Asphalt built-up flat roof</b>	1.5	20.0
<b>Hypalon (rubber) flat roof</b>	1.5	20.0

<sup>1</sup> DIN 1989-1:2001-10. DIN 1989 Rainwater Harvesting Systems - Part 1: Planning, Installation, Operation and Maintenance. 2002. Fachvereinigung Betriebs- und Regenwassernutzung e.V. fbr, Darmstadt, Germany.

<sup>2</sup> Building Capacity for Rainwater Harvesting in Ontario: Rainwater Quality and Performance of RWH Systems. 2008. Despins, C. M.Sc. Thesis, University of Guelph.

### Rainwater quality

The quality of rainwater runoff from a catchment surface can be affected in two ways. Dirt and debris can collect on the roof surface from direct atmospheric deposition, from overhanging foliage or bird and rodent droppings. Alternatively, the roof material itself can contribute both particulate matter and dissolved chemicals to runoff water. This issue is a concern for all RWH systems and is discussed in greater detail in *chapter 3. Rainwater quality and treatment*. Dissolved particulate matter and chemicals are generally only a concern if rainwater is to be used for potable water applications and, as such, these issues are not directly addressed in this manual (refer to NSF Protocol P151 for further guidance on this issue, see *section 1.2 Applicable codes, standards and guidelines* for details).

### Rainwater conveyance

Once collected from the catchment surface, rainwater is transferred to the rainwater storage tank through a series of components, referred to as the 'conveyance network.' An illustration of a typical conveyance network for a residential household is provided in figure I-3.

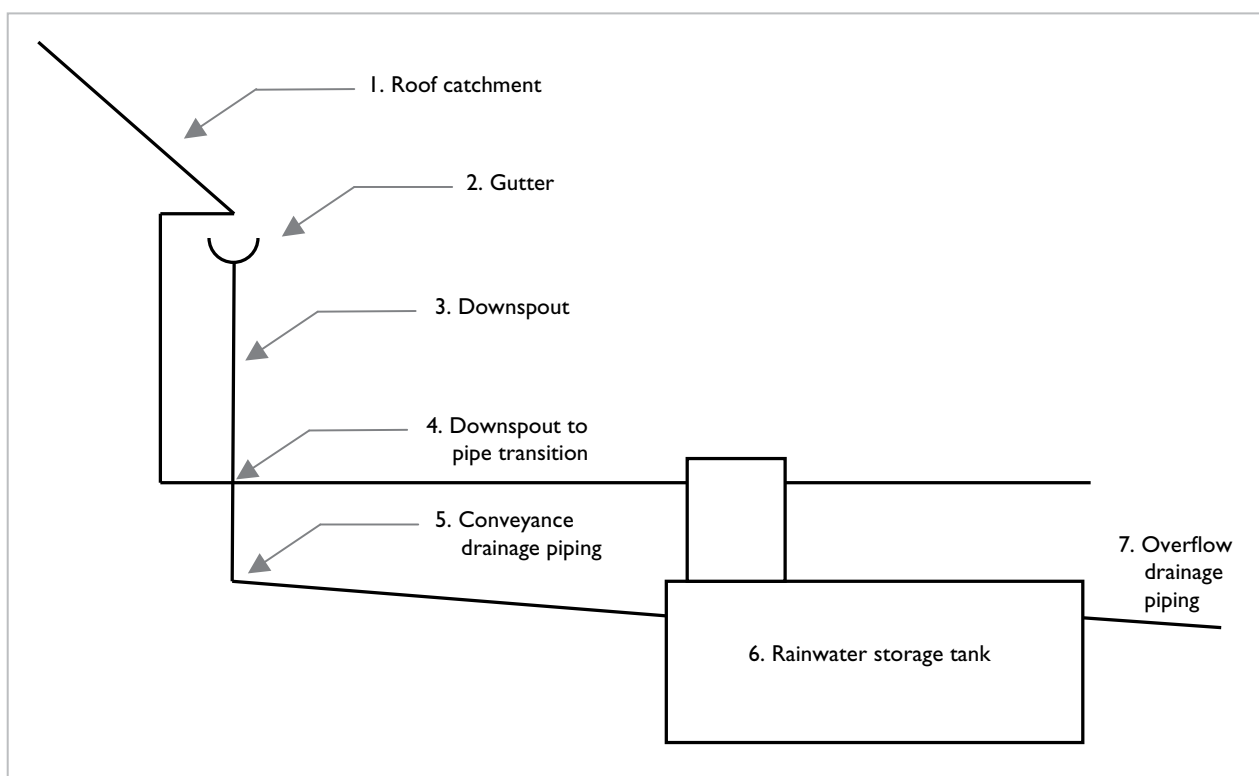

**Figure I-3** A typical conveyance network for a below-ground rainwater storage tank

When designing and installing a conveyance network, a number of issues must be considered, including:

- sizing and placement of conveyance network;
- site conditions and location/placement of storage tank;
- cold weather issues; and
- rainwater quality.

These issues are examined in greater detail in the following sections.

### **Size, slope and placement of conveyance network**

---

To ensure that the conveyance network can handle the runoff from the catchment surface in severe storms, all sections of the conveyance network (gutters, downspouts and drainage piping) must be appropriately sized and sloped to promote the rapid water drainage. The design of gutters and downspouts is generally not dependent upon building code specifications; rather, there are standard sizes and 'rules of thumb' for residential applications. Conveyance drainage pipes must be sized in accordance with the applicable provincial/territorial codes and regulations, (refer to *section 1.2 Applicable codes, standards and guidelines* for details).

When sizing pipes and other parts of the conveyance network, it is important to consider what proportion of the catchment surface a particular section of the network is handling. In a majority of cases, the catchment surface will be divided into sections for the collection and conveyance of rainwater (for example, a peaked roof will have at least two distinct drainage areas where rainwater will be collected). Accordingly, it may be necessary to have multiple smaller conveyance drainage pipes that transfer rainwater to a larger pipe leading into the rainwater storage tank.

### **Site conditions and tank location**

---

When planning a conveyance network, it is important to take into consideration the site conditions and location/placement of the rainwater storage tank. It may be difficult to connect some sections of the catchment surface to the conveyance network due to grading and/or layout of the site, distance to the storage tank or complex roof shapes. For instance, when designing the layout of the conveyance drainage pipe transferring rainwater to a below-ground tank, the length of pipe and pipe slope can affect the burial depth of the tank (for example, force it to be buried deeper below ground). Some tanks, however, cannot be buried below a maximum rated burial depth and, consequently, the location of the tank or the pipe slope may need to be adjusted. Alternatively, a reinforced tank designed for deeper burial may have to be selected. Refer to *chapter 2. Rainwater storage and tank sizing* for further details.



Another concern when designing conveyance networks leading to below-ground tanks is the presence of buried service lines (gas, water, phone, etc.). An inspection of the site to locate the service lines must be performed to ensure that the planned route is free from buried lines.

### **Conveyance network material selection**

---

Part of planning the conveyance network is selecting the appropriate material for each of the network components. Gutters and downspouts are generally manufactured out of aluminum or galvanized steel, both of which are considered suitable for RWH systems. When selecting a pipe material, a number of criteria must be considered. The pipe selected must be rated as suitable for ultraviolet (UV) light exposure and burial (where applicable), and, if rainwater quality is a concern, it must be rated for handling potable water. In addition, the selected pipe must be approved by the applicable provincial or territorial codes and regulations. In general, a type of polyvinyl chloride (PVC) pipe, referred to as “sewer grade pipe” or “PVC SDR35” is recommended for RWH systems, as it meets these criteria. Acrylonitrile-butadiene-styrene (ABS) is another type of pipe that can be used, and is typically less expensive than PVC SDR35 but may not be appropriate for all RWH systems as it is not rated for UV exposure. It is important to note, however, that, even if rainwater is conveyed using a pipe suitable for potable water, this does not imply that rainwater is potable or suitable for potable use.

### **Cold weather issues**

---

Throughout much of Canada, temperatures often drop below freezing (0°C) during the winter months. During periods of extreme cold weather, rainwater that is outdoors or in an environment that is not temperature controlled (maintained above 0°C) is at risk of freezing. Rainwater can freeze in the conveyance network if it is not drained adequately or if it must travel through extended portions of the network that are not temperature controlled.

### **Rainwater quality**

---

When planning the rainwater catchment and conveyance network, the quality of rainwater entering the storage tank may be improved by excluding the catchment of rainwater from specific materials or sections of the catchment surface, such as sections that utilize a green roof or sections with overhanging foliage. If quality is a concern but the amount of rainwater collected must be maximized by collecting from some of these surfaces, rainwater can be treated before use. Refer to *chapter 3. Rainwater quality and treatment* for further details.

Rainwater quality can also be improved by preventing the entry of contaminants into the tank by means of the conveyance network. To prevent the entry of animals or insects into the tank, all sections of the conveyance network must be structurally sound and not have any holes or other points of entry other than those required for water flow. Particular attention should be paid to the transitions between components, especially the transition from the downspout to the conveyance drainage pipe, which is usually located at ground level.

## I.4 DESIGN AND INSTALLATION GUIDELINES

### 1. When selecting the catchment(s) for collecting rainwater:

- a. only roof surfaces are recommended;
- b. collection from green roofs is not recommended;
- c. sections of the roof with overhanging foliage or trim where possible should be avoided; and
- d. if rainwater collected from the catchment surface must be of very high quality, materials with NSF P151 certification can be selected.

### 2. To maximize the volume of rainwater collected by the RWH system:

- a. the catchment surface should be as large as possible;
- b. if a roof catchment material is to be selected and installed in conjunction with the RWH system, material with minimal collection losses, such as steel, should be selected (refer to table A-1 for details);
- c. convey rainwater using appropriately sized and sloped components, including gutters, downspouts, and/or conveyance drainage piping; and
- d. where possible, multiple roof catchments can be connected to a central or 'communal' rainwater storage tank.

### 3. Gutters and downspouts

- a. Gutter and downspout materials
  - i. Aluminum or galvanized steel are recommended.
  - ii. Copper, wood, vinyl and plastic gutter and downspout materials are not recommended.
  - iii. If rainwater conveyed through gutters and downspouts must be of very high quality, materials with NSF P151 certification can be selected.
- b. Gutter slope
  - i. Where possible, slope gutters in the direction of the location of the rainwater storage tank.
  - ii. Ensure a minimum slope of 0.5-2% (the greater the slope the better) is maintained throughout the gutter length.

c. Gutter size

- i. In general, 125 mm [5 in.] K-style gutter is commonly used and should be suitable for most typical residential roof drainage areas and gutter lengths.
- ii. To determine the gutter size required for a given roof drainage area:
  - 1. consult the applicable provincial/territorial codes and regulations pertaining to the design rainfall intensity for the site location; and
  - 2. calculate the area of roof draining into the gutter:

$$\text{Roof drainage area (m}^2\text{)} = \text{Length (m)} \times \text{Width (m)}$$

Equation 1-1

**Where:** *Length* = length of the gutter served by a downspout (m)  
*Width* = distance from the eave to the ridge of the roof drainage area served (m)

- 3. Refer to table 1-3 to determine the minimum size of gutter required, based on the roof drainage area (m<sup>2</sup>) and design rainfall intensity values determined above:

**Table 1-3** Minimum gutter sizes for given roof drainage areas and rainfall intensities<sup>3</sup>

Minimum required gutter size and type	Maximum roof drainage area served per downspout (m <sup>2</sup> ) <sup>1,2</sup>							
	Design rainfall intensity (15 min rainfall, mm):							
	18.75	25	31.25	37.5	43.75	50	56.25	62.5
<b>100 mm [4 in.] K-style</b>	71	53	43	35	30	27	24	21
<b>125 mm [5 in.] K-style</b>	130	98	78	65	56	49	43	39
<b>150 mm [6 in.] K-style</b>	212	159	127	106	91	79	71	64

<sup>1</sup> Minimum required gutter size assumes that gutters have a minimum slope (≤ 6.25%). For greater gutter slopes, the table values may be multiplied by 1.1.

<sup>2</sup> Maximum roof drainage area assumed roof slopes ≤ 5:12. For steeper roof pitches, multiply the table values by 0.85.

- iii. For other gutter types and/or larger roof drainage areas, consult the gutter manufacturer or contractor regarding gutter size.

d. Location and spacing of downspouts

- i. Where possible, locate downspout(s) near the rainwater storage tank.
- ii. Locating downspouts at inside building corners is not recommended.
- iii. Downspouts must serve no more than 15 m [50 ft.] of gutter length.

<sup>3</sup> Adapted from Moisture Resistant Homes: A Best Practice Guide and Plan Review Tool for Builders and Designers. 2006. U.S. Department of Housing and Urban Development, Washington, D.C.

## e. Downspout size

- i. In general, 50x75 mm [2x3 in.] rectangular-type downspouts or 75x75 mm [3x3 in.] square-type downspouts are commonly used and should be suitable for most typical residential roof drainage areas and gutter lengths.
- ii. To determine the size of downspout required:
  - I. Refer to table I-4 to determine the minimum size of downspout (either rectangular or square type) based on the size of the gutter the downspout is serving.

**Table I-4** Minimum downspout sizes for given gutter sizes<sup>4</sup>

Gutter size and type	Minimum downspout size ( mm [in.] )	
	Rectangular type	Square-type
<b>100 mm [4 in.] K-style</b>	50 x 75 [2 x 3]	75 x 75 [3 x 3]
<b>125 mm [5 in.] K-style</b>	50 x 75 [2 x 3]	75 x 75 [3 x 3]
<b>150 mm [6 in.] K-style</b>	75 x 100 [3 x 4]	100 x 100 [4 x 4]

- iii. For other downspout types and/or larger gutter sizes, consult the gutter/downspout manufacturer or contractor regarding downspout size.

## f. Gutter and downspout installation

- i. Gutters should be custom-fabricated and installed so that there are no seams along the gutter length.
- ii. Gutters must be supported by hangers (hidden hanger or spike and ferrule) spaced at a maximum of 450 mm [18 in.].
- iii. Downspout offsets should not exceed 3.0 m [10 ft.].

g. Refer to **Appendix A** for examples of gutter and downspout sizes.

## 4. Catchment area:

- a. Determine catchment area using:

$$\text{Catchment area (m}^2\text{)} = \text{Length (m)} \times \text{Width (m)}$$

Equation 1-2

**Where:** *Length* = length of the catchment surface (m)

*Width* = width of the catchment surface (m)

<sup>4</sup> Adapted from Moisture Resistant Homes: A Best Practice Guide and Plan Review Tool for Builders and Designers. 2006. U.S. Department of Housing and Urban Development, Washington, D.C.

- b. In cases where sections of one roof catchment or multiple catchment surfaces are used, the catchment area can be determined by summing the multiple smaller areas.

## 5. Plan the layout of the conveyance network:

- a. For above-ground rainwater tanks
  - i. Determine the location of the tank (refer to *chapter 2. Rainwater storage and tank sizing* for guidance).
  - ii. Route downspout(s) and/or conveyance drainage piping into the tank.
- b. For below-ground rainwater tanks
  - i. Determine the location of the tank (refer to *chapter 2. Rainwater storage and tank sizing* for guidance).
  - ii. Plan route of conveyance drainage piping from the downspout(s) to the tank.
  - iii. Ensure that there are no buried service lines (gas, electricity, water; stormwater; wastewater; phone or cable lines) in the area where digging will take place to accommodate the buried conveyance drainage pipes by contacting the municipality and service providers.
  - iv. For additional guidance on planning the layout of conveyance drainage piping for below-ground tanks, refer to *Appendix A*.

## 6. Conveyance drainage pipes

- a. Pipe material
  - i. PVC SDR35 pipe or ABS pipe is recommended.
  - ii. Pipe selected must be approved by applicable provincial/territorial codes and industry standards (CSA, ASTM, etc.).
- b. Pipe size and slope
  - i. Ensure a minimum slope of 0.5-2% (the greater the slope the better) is maintained throughout the pipe length.
  - ii. Consult the applicable provincial/territorial codes and regulations pertaining to conveyance drainage pipe sizing.
  - iii. For estimation purposes, consult table A-1 and table A-4 in *Appendix A*.
- c. Cleanouts
  - i. Cleanouts are required on conveyance drainage pipes to facilitate cleaning of the conveyance drainage pipes.
  - ii. Consult the applicable provincial/territorial codes and regulations pertaining to size and spacing of cleanouts, manholes and location of cleanouts.
- d. Tank connection
  - i. Rainwater conveyance drainage piping should enter the tank at a height no lower than the overflow drainage piping, or, ideally, 50 mm [2 in.] above the bottom of the overflow drainage pipes entering the tank.

**7. Installation of conveyance drainage pipe**

- a. Above-ground pipes shall be supported in accordance with applicable provincial/territorial codes and regulations.
- b. Below-ground pipes shall be located in a properly excavated space, supported and properly backfilled in accordance with applicable provincial/territorial codes and regulations.
- c. Pipe freeze protection
  - i. Ensure that all buried pipes are located below the frost penetration depth. Consult local building authorities regarding regulations or 'rules of thumb' for frost penetration depths. For estimation purposes, refer to *Appendix A*.
  - ii. Provide insulation or heat tracing for pipes buried above the frost penetration depth or exposed above grade (refer to *Appendix A* for details regarding pipe insulation).
- d. Underground non-metallic pipes should be installed with 'tracer tape' (also referred to as 'tracer wire') at a height of 300 mm [12 in.] above the pipe for the purpose of locating as-installed piping.
- e. Consult the pipe manufacturer's installation instructions regarding recommended pipe bedding, support and backfilling procedures.

**8. Tank frost protection**

- a. Storage tanks located above ground at risk for freezing shall be protected by:
  - i. a conveyance network bypass, where sections of downspout and/or pipe upstream of the tank shall be capable of being disconnected and/or rerouted to divert rainwater/snowmelt from entry into the tank during winter months; and
  - ii. a drain valve located at the bottom of the storage tank.

**9. Ensure that there are no means of entry for small animals or insects into the rainwater storage tank from the conveyance network by:**

- a. properly installing all sections of the conveyance network so that they do not have any holes or other points of entry other than those required for waterflow; and
- b. installing downspout-to-pipe transition fittings.

**10. Install pre-storage treatment devices as required (refer to *chapter 3. Rainwater quality and treatment* for details).**

## I.5 MANAGEMENT GUIDELINES

- 
1. **The catchment surface should be inspected once every six months to:**
    - a. identify any sources of contamination, including accumulated dirt and debris, presence of overhanging tree branches or other foliage, and/or signs of animal activity (for example, bird droppings); and
    - b. if contaminants are present, these should be removed by cleaning the catchment surface by hosing or sweeping and, if applicable, trimming overhanging tree branches/ foliage.
  2. **The gutters and downspouts should be inspected once every six months to:**
    - a. remove accumulated dirt and debris; and
    - b. repair and/or replace damaged components to ensure proper rainwater flow and prevent entry of birds, rodents or insects into the RWH system.
  3. **During periods of cold weather, the conveyance network should be inspected periodically for ice build up.**
    - a. Inspect the components of the conveyance network that are easily accessible (roof inspection not recommended) for the presence of ice and, if present, monitor over time to determine whether ice is accumulating in the network.
    - b. For buried pipelines, ice buildup may be identified by poor performance of the RWH system (low volumes of stored rainwater even during frequent freeze-thaw periods) and/or by rainwater backing up in upstream sections of the network.
  4. **If ice is accumulating in sections of the conveyance network, and if it poses a risk of blocking and/or causing damage to the network, the following steps are recommended.**
    - a. Winterize the conveyance network by some or all of the following means.
      - i. Install a heating system to maintain air temperature above 0°C if a large portion of the conveyance network is located in a cold indoor environment like a garage.
      - ii. Install heat trace wire around gutters and/or downspouts.
      - iii. Excavate the conveyance drainage pipes and install rigid Styrofoam™ insulation or heat tracing.
    - b. Alternatively, the RWH system can be decommissioned during the winter months (refer to **section 2.5 of chapter 2. Rainwater storage and tank sizing** for details).
  5. **While inspecting, cleaning or repairing the catchment surface and parts of the conveyance network, follow all necessary safety precautions.**

The background of the top section of the slide is a close-up photograph of water with numerous ripples, creating a textured, blue-toned surface. The ripples are concentric circles of varying sizes, suggesting raindrops falling into a pool of water.

# Chapter 2

## Rainwater storage and tank sizing



## 2.1 INTRODUCTION

The reservoir that is used to store rainwater harvested from roof catchments is often referred to as a rainwater storage tank, or sometimes as a 'rainwater cistern' or 'holding tank.' Rainwater storage tanks are available in a variety of different materials—concrete, plastic, fibreglass, etc.—and can be installed either above ground or below ground or, alternatively, directly integrated into a building (for example, built into a basement wall or foundation).

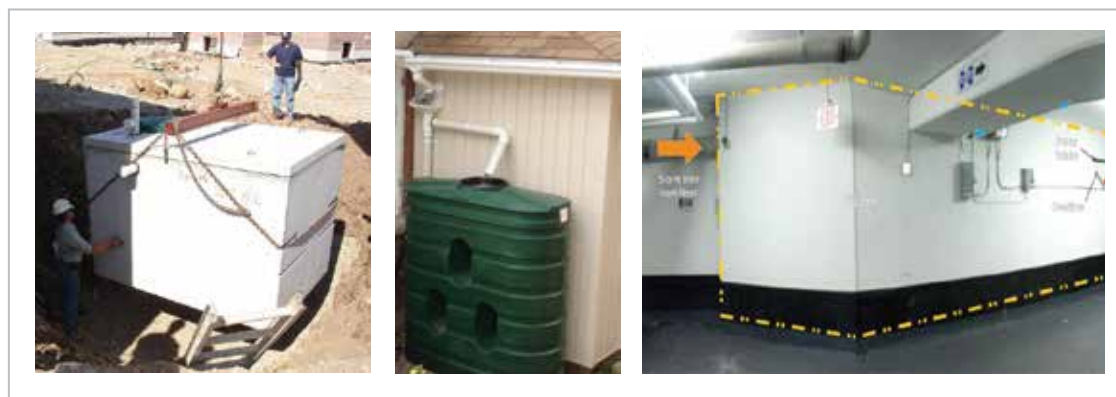

**Figure 2-1** Left Precast concrete tank (below-ground application),  
Centre Plastic tank (above-ground application) and  
Right Cast in place concrete tank integrated into a parking garage (integrated storage)<sup>5</sup>

The storage capacity of rainwater storage tanks can also vary—from several hundred litres for a typical rain barrel to thousands of litres for commercially available above-ground or below-ground holding tanks. In addition to acting as the primary storage reservoir, the rainwater storage tank can also be considered as the central hub of an RWH system. It is the central location for handling all of the rainwater going into (and coming out of) the RWH system and many important components, such as the pump and water level sensor, are often located directly within the tank itself.

Care must be taken during its selection, installation and maintenance to ensure the proper functioning and optimal performance of the RWH system. This chapter discusses the issues that must be considered when performing these tasks, and also provides guidance on how to maximize the collection efficiency of RWH systems while keeping the size (and cost) of rainwater tanks as small as possible.

<sup>5</sup> Image of cast in place tank © Toronto and Region Conservation Authority, Toronto, ON.

## 2.2 APPLICABLE CODES, STANDARDS AND GUIDELINES

Table 2-1 references specific codes and standards that are applicable to rainwater storage tanks.

**Table 2-1** Applicable standards, codes and guidelines for rainwater storage tanks.

Applicable codes, standards and guidelines	Selected provisions and design and installation implications
<b>Canada Occupational Health and Safety Regulations (2010)</b>	<ul style="list-style-type: none"> <li>■ <b>Part XI Confined Spaces</b></li> </ul> Where entry into a rainwater tank is needed to install components, precautions outlined in Part XI Confined Spaces must be followed.
<b>CSA Standard B128.1 (2006)</b>	<ul style="list-style-type: none"> <li>■ <b>7.0 Storage Tanks</b></li> </ul> Provides specifications for the design and installation of rainwater storage tanks, including: access openings, piping connections, overflow, drainage and venting.
<b>NSF/ANSI Standard 61 (2008)</b>	Selection of a plastic tank with NSF/ANSI Standard 61 certification will not introduce unsafe levels of contaminants into drinking water. Recommended where high quality rainwater is needed for the intended use.

Mandatory documents       Supplementary documents

## 2.3 ISSUES FOR CONSIDERATION

### General

As the central hub of an RWH system, the rainwater storage tank is directly connected to a number of pipes and also houses some components internally. These components may include some, or all, of the following items shown in figure 2-2.

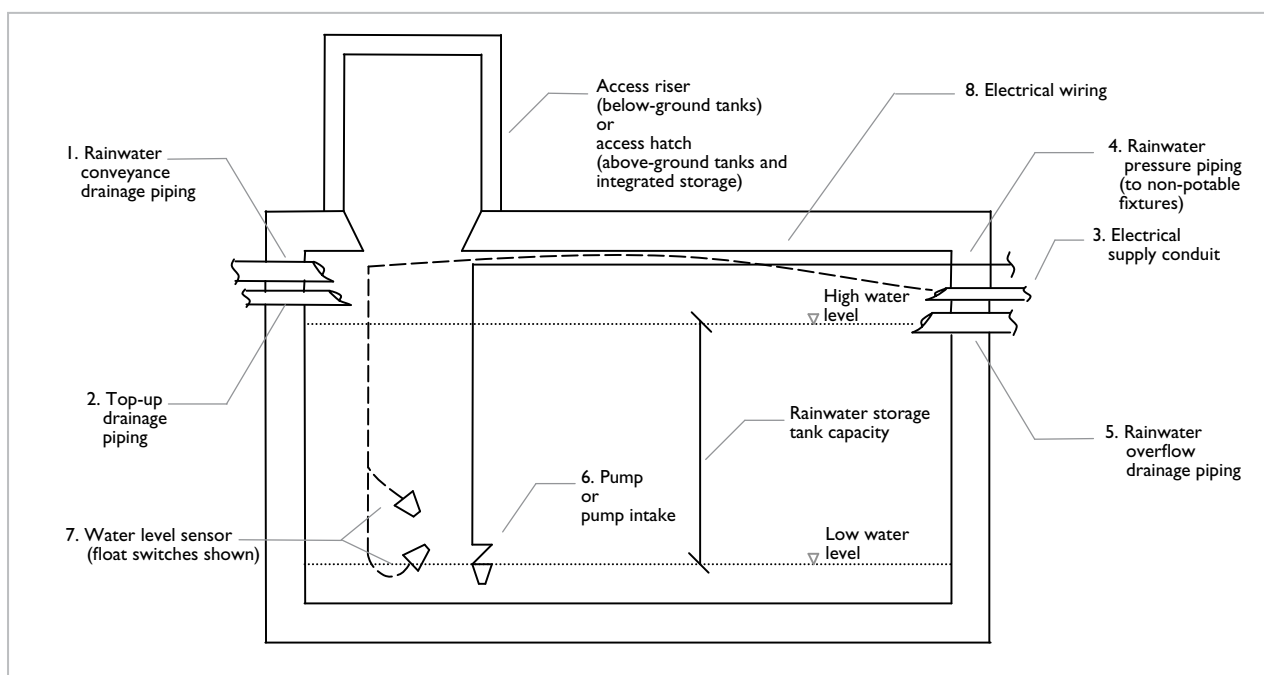

**Figure 2-2** Rainwater storage tank

### Tank location

The optimum location of a tank on a given site depends on the required fall for the gravity flow conveyance network (as discussed in *chapter 1. Rainwater catchment and conveyance*), as well as a broader range of issues, including:

1. placement of tank – above ground or below ground, or integrated into a building;
2. desired/required rainwater storage tank capacity;
3. regional climate – freezing issues;
4. site conditions – site grading, accessibility and space availability; and
5. proximity to the following:
  - a. catchment area;
  - b. overflow discharge location;
  - c. control components of pump and pressure system; and
  - d. other site services (for example, gas, electricity, water, stormwater, wastewater, phone or cable lines).

Following consideration of each of these issues, it is likely that trade-offs must be made—for instance, the optimum tank storage capacity may be too large to be accommodated at the site, or the optimum location for the tank may be in an area that is difficult to access. Some guidance with respect to these issues is provided in the following sections.

## Tank placement

Table 2-2 discusses some of the advantages and disadvantages associated with the different placement options with regard to rainwater storage.

**Table 2-2** Advantages and disadvantages of different tank locations

Tank placement	Advantages	Disadvantages
<b>Above ground</b>	<ul style="list-style-type: none"> <li>Don't have site excavation costs associated with below-ground storage</li> </ul>	<ul style="list-style-type: none"> <li>Rainwater may freeze in tank unless located in temperature controlled environment</li> </ul>
<b>Below ground storage</b>	<ul style="list-style-type: none"> <li>Storage tank can be placed below frost penetration depth, permitting year-round operation</li> <li>Does not take up yard space</li> </ul>	<ul style="list-style-type: none"> <li>Location must be free of buried service lines and accessible to excavation machinery</li> <li>Excavation requires additional site work, which increases cost of RWH system</li> </ul>
<b>Integrated storage</b>	<ul style="list-style-type: none"> <li>Little or no excavation cost</li> <li>Storage tank capacity can be customized for each site</li> <li>Permits year-round operation</li> </ul>	<ul style="list-style-type: none"> <li>Engineers must design storage reservoir such that it is structurally sound and does not leak into the building</li> </ul>

## Tank capacity

In general, the larger the tank, the greater the volume of rainwater that can be collected and stored during rainfall events (collection efficiency). However, this is true only up to a certain point—after which other factors, such as local rainfall patterns, roof catchment area and rainwater demand, will limit the amount of rainfall that can be collected and utilized by the system. Thus, for an RWH system with a given roof catchment area, rainwater demands and local rainfall patterns, the storage capacity of the tank can be described as either:

- 1. Too small** – Much of the collected rainwater overflows during rainfall events. Significant improvements in collection efficiency can be achieved with minor incremental increases in storage volume.
- 2. Optimum range** – Rainwater tanks in this range provide the best balance between collection efficiency of the RWH system and minimizing its size and cost.

- 3. Too large** – Rainwater tanks in this range rarely fill to capacity. A smaller tank can be used without a significant drop in the collection efficiency of the RWH system. An oversized rainwater storage tank, however, may be desirable if stormwater management is a strong driver for installing an RWH system.

To determine the appropriate rainwater storage tank capacity, two methods are available:

**Rainwater harvesting design tool** – This is a Microsoft Excel-based program that can be used to determine the optimal storage tank capacity given site-specific details, including city, catchment area and material, and rainwater demands. For further details regarding this companion to the *Guidelines for Residential Rainwater Harvesting Systems*, refer to *Appendix B*.

**Rainwater storage tank sizing tables** – Tables of optimal rainwater tank capacities have been generated using the Rainwater harvesting design tool for various regions of Canada, given a variety of roof catchment areas and rainwater demands. These tables are provided in *Appendix B*.

Note that, when selecting a tank size, consideration must be given to the unused volume at the bottom and top of the tank (sometimes referred to as 'dead space'), which reduces the effective storage volume. Refer to *chapter 4. Make-up water system and backflow prevention* and *chapter 5. Pump and pressurized distribution system* for information regarding dead space at the bottom of the tank.

## Cold weather issues

---

Throughout much of Canada, temperatures often drop below freezing (0°C) during the winter months. Rainwater stored outdoors or in an environment that is not temperature controlled (maintained above 0°C) is at risk of freezing, either in the storage tank itself, in the pump pressure piping, or both. Water freezing in either location may cause short term blockages and service disruptions or, in the long term, the RWH system may become damaged through the expansion of ice in the system. To minimize these risks, the following options are available:

- 1. Winter decommissioning** – If an outdoor above-ground tank is used to store rainwater (or other setup in a non-temperature controlled setting), the tank, pump and pressurized lines shall be drained of all rainwater prior to the onset of cold weather and use of the system shall be discontinued during the winter months.
- 2. Winterize RWH system** – An RWH system can be used year-round in cold climates if it is:
  - a. located in a temperature-controlled environment such as a heated garage or basement in the case of above-ground or integrated rainwater storage; or
  - b. located in a below-ground tank that is buried below the local frost penetration depth.

The first option is generally the simplest and least costly system to design and install. These benefits, however, are largely offset by the significant reduction in rainwater that can be collected and used throughout a given year, as well as by the potential damage to

system components if decommissioning occurs too late or not at all. The second option, to winterize the system, is more complicated and more costly; however, it is preferred since it enables the RWH system to operate throughout the entire year and ensures system components are protected from frost damage.

### Tank material

In Canada, materials such as concrete, plastic and fibreglass are commonly used in the construction of storage reservoirs. The selection of one of these materials for a rainwater storage tank will largely depend on local availability, as well as on cost, tank placement (above ground or below ground or integrated), storage requirements, site accessibility and/or engineering specifications. In recent installations, above-ground tanks are often plastic while integrated tanks are usually cast-in-place concrete. Below-ground tanks are usually precast concrete or plastic. In general, greater economies of scale are seen for concrete tanks than for plastic tanks, making concrete a more desirable material for very large systems. Engineering specifications, such as maximum rated burial depth or minimum required water level, vary for different tank materials and designs. Installation and operational specifications can be sought from manufacturers.

Another consideration is the potential for chemicals to leach from the tank into the stored rainwater; however, this is primarily a concern if rainwater must be of very high quality for one or more of the connected fixtures.

## 2.4 DESIGN AND INSTALLATION GUIDELINES

### 1. Determine the rainwater storage tank capacity

- a. If the rainwater storage tank will be used for stormwater retention and/or as part of a stormwater management system, the tank shall be sized as required by local authorities (refer to *chapter 6. Overflow provisions and stormwater management* for details).
- b. For storage tanks used for rainwater harvesting purposes:
  - i. use the Rainwater harvesting system design tool (refer to *Appendix B* for instructions on accessing the design tool); or
  - ii. use the method provided in the *Rainwater storage tank sizing table* section of *Appendix B*.
- c. If sizing the tank without reference to the design tool or tank sizing table, consider:
  - i. the unused volume (typically referred to as the 'dead space') when selecting tank size. If unknown, assume 20% of tank capacity will be dead space; and
  - ii. the collection losses from pre-storage treatment devices (refer to *chapter 3. Rainwater quality and treatment* for details).

### 2. Determine the type of material used for the rainwater tank, based on:

- a. placement (above-ground or below-ground or integrated storage);
- b. storage volume requirements;
- c. engineering specifications (see *section 2.2 Applicable codes, standards and guidelines* for applicable standards and consult with manufacturers for further specifications); and

- d. connected rainwater fixtures and desired quality. (see section 3.2 *Applicable codes, standards and guidelines* for applicable standards).

### 3. Determine the location of the rainwater storage tank:

- a. For all rainwater storage tank locations
  - i. Ensure the location allows for:
    - 1. proper drainage of rainwater through the conveyance network (refer to *chapter 1. Rainwater catchment and conveyance* for details);
    - 2. proper drainage of make-up water through top-up drainage piping (refer to *chapter 4. Make-up water system and backflow prevention* for details); and
    - 3. proper drainage of rainwater from the storage tank into an appropriate stormwater discharge location (refer to *chapter 6. Overflow provisions and stormwater management* for details).
  - b. For below-ground storage tanks
    - i. Identify the area(s) where the tank can be located.
      - 1. Ensure the location is free from buried service lines. Contact service providers to determine the location of buried service lines (gas, electricity, water, stormwater, wastewater, phone or cable lines).
      - 2. Ensure the location is permitted by applicable provincial/territorial codes and regulations based on the minimum clearance requirements for buried tanks.
      - 3. Ensure the location is accessible to excavation equipment and the tank delivery vehicle. Consult the excavation contractor and tank supplier for exact requirements.
    - ii. Tank freeze protection.
      - 1. Locate the tank such that the high water level in the tank is at a depth below the frost penetration depth (consult the tank manufacturer regarding the rated burial depth of the tank).
      - 2. Consult applicable provincial/territorial codes and regulations and/or local building authorities to determine local frost penetration depth (refer to *Appendix A* for an estimation of frost depth).
      - 3. If the tank cannot be placed below frost depth, insulate with rigid Styrofoam™, installed on the tank roof and extended out beyond the tank walls (refer to *Appendix A* for guidelines regarding thickness of foam insulation).
  - c. For above-ground storage tanks
    - i. Identify the area(s) where the tank can be located.
      - 1. Ensure the location is permitted by applicable provincial/territorial codes and regulations and municipal zoning bylaws. Consult local building authorities for details.
      - 2. Ensure the location has sufficient space for access above and around the tanks for inspection and maintenance.
    - ii. Tank freeze protection
      - 1. If the tank is not located in a temperature-controlled environment and is at risk of freezing, winterizing or decommissioning must be performed in accordance with the guidelines below.
  - d. For rainwater storage tanks located in a building and/or integrated into a building
    - i. Identify the area(s) where the tank can be located.
      - 1. Ensure the location is permitted by applicable provincial/territorial codes and regulations and municipal zoning bylaws. Consult local building authorities for details.
      - 2. Ensure the location has sufficient space for the required storage volume.
      - 3. Ensure the location has sufficient space for access above and around the tanks for inspection and maintenance.

4. Ensure provisions (such as floor drains and/or sump pump) are in place to handle potential leaks and overflows from the storage tank.
5. Consult a structural engineer regarding the design and location of all integrated tanks, as well as indoor tanks located anywhere other than the basement or garage.

ii. Tank freezing protection

1. Locate the tank in a temperature-controlled environment such as a heated garage or basement to prevent tank freezing.
2. If the tank is not located in a temperature-controlled environment and is at risk of freezing, winterizing or decommissioning must be performed in accordance with the guidelines below.

**4. Tank frost protection**

- a. If the tank is not located in a temperature-controlled environment and is at risk of freezing, winterizing or decommissioning must be performed.

i. Winterizing

1. Provide a heating system to maintain air temperatures above 0°C (if tank is located indoors).
2. Provide a water heating system directly inside the rainwater tank.
3. Insulate the rainwater storage tank.

ii. Decommissioning

1. Prior to the onset of freezing temperatures, the rainwater stored in the rainwater tank must be drained.
2. Provisions shall be made to prevent the accumulation of rainwater and/or snowmelt into the tank during winter months by means of a tank bypass or tank drain valve (refer to *section 1.4 Design and installation guidelines* for further details).

**5. Tank access and openings<sup>6</sup>**

- a. Tanks shall be provided with an access opening.
- b. Access openings shall be a minimum of 450 mm [18 in.] to facilitate installation, inspection and maintenance of components in the rainwater storage tank.
- c. Access openings shall have drip-proof, non-corrosive covers.
- d. Openings that are larger than 100 mm [4 in.] shall have lockable covers.
- e. Consult applicable provincial/territorial codes and standards regarding tank access and openings.

**6. Tank venting**

- a. For below ground rainwater storage tanks
  - i. In general, venting of the tank through the rainwater conveyance drainage piping and overflow drainage piping connected to the tank is considered to be sufficient for a typical single-family residential dwelling.
  - ii. For other dwellings, or in cases where venting by means of the conveyance drainage piping and overflow drainage piping connections is considered insufficient, a vent shall be installed on each tank, where:
    1. the vent pipe shall extend from the top of tank to a minimum height of 150 mm [6 in.] above grade;

<sup>6</sup> Adapted from CAN/CSA-B128.1-06 Design and installation of non-potable water systems. 2006. CSA International, Mississauga, ON. Refer to CSA B128.1 for further details.



2. the vent pipe shall be of a sufficient size to permit the flow of air while the tank is filling, and shall be no less than 75 mm [3 in.] in size; and
  3. the vent shall terminate in a gooseneck fitting with a screen to prevent the entry of birds, rodents and insects.
- b. For rainwater storage tanks located indoors and/or integrated into buildings
- i. Rooms containing open tanks shall be vented to the outside of the building to prevent the accumulation of humidity and noxious gases.

#### **7. Installation of storage tanks**

- a. Below-ground tanks shall be placed in a properly excavated space, be supported on a tank bedding and be properly backfilled in accordance with applicable provincial/territorial codes and standards.
- b. Integrated storage tanks must be constructed and/or installed in accordance with the designer's instructions and good engineering practices.
- c. Consult the tank manufacturer's installation instructions regarding recommended tank bedding, support and backfilling procedures.
- d. Connect the rainwater conveyance drainage pipe(s), overflow drainage pipe(s), rainwater pressure pipe(s) and electrical conduit(s) to the tank, ensuring that the connections are properly sealed and watertight.

#### **8. Installation of components in the rainwater storage tank**

- a. Components installed in the tank typically include:
  - i. a pump or pump intake (refer to *chapter 5. Pump and pressurized distribution system* for details);
  - ii. water level sensors and/or other types of control equipment; and
  - iii. electrical wiring for the pump and control equipment (refer to *chapter 4. Make-up water system and backflow prevention* for details).
- b. Entry into the rainwater storage tank for the purpose of installing components within the tank is not recommended.
- c. If entry into the rainwater storage tank is required, it shall be performed in accordance with Part XI Confined Spaces of the *Canada Occupational Health and Safety Regulations* due to the significant dangers involved when working in a confined space.
- d. To reduce and/or eliminate the need to perform work inside the storage tank:
  - i. wherever possible, install internal components using the access port, without entering the tank; or
  - ii. have RWH components installed by tank manufacturer, using personnel trained to work in confined spaces.
- e. Install components so that they are accessible for inspection and maintenance, without entry into tank.
- f. Components installed in the tank should be suited to a wet environment.

## 2.5 MANAGEMENT GUIDELINES

- I. Rainwater tanks should be inspected at least once a year for the following:
  - a. Leaks
    - i. For below-ground storage tanks, leaks may be identified through poor performance of the RVWH system (for example, the make-up water system operates often), from moist soil conditions surrounding the tank and/or excessive settling of the tank in the excavated space.
    - ii. For above-ground storage tanks and integrated storage, leaks can be identified visually by examining the area surrounding the tanks, or through poor system performance or soil moisture (if applicable).
  - b. Accumulation of debris
    - i. Sediment may accumulate on the bottom of the tank and, depending on the treatment provided, appear at the point of use. In such cases, the location (height) of the pump intake may need adjustment. Adjust the location of the pump intake so that it is located 100-150 mm [4-6 in.] above the bottom of the tank.
    - ii. If sediment is still detected at the point of use, pre-storage and/or post-storage treatment devices may need to be installed (or cleaned/maintained) to improve rainwater quality (refer to *chapter 3. Rainwater quality and treatment* for details).
    - iii. In some cases, it may be necessary to remove the accumulated sediment at the bottom of the tank. Place a pump capable of handling large debris and/or solids (for example, a suitable sump pump or effluent pump) at the bottom of the tank to pump out the sediment layer. (Note: removal of sediment and/or tank cleaning is not generally recommended on an annual basis, as this can destroy beneficial 'biofilms' in the tank. These biofilms may contribute to improved stored rainwater quality<sup>7</sup>.)
  - c. Fault with pump, water level sensors or other control equipment
    - i. Refer to *chapter 4. Make-up water system and backflow prevention* and *chapter 5. Pump and pressurized distribution system* for maintenance details.
  - d. While inspecting, cleaning or repairing the tank, follow all necessary safety precautions, such as those listed in *section 2.2 Applicable codes, standards and guidelines*.
2. If tank is susceptible to freezing (for example, outdoor above ground), either winterize or decommission the system prior to the onset of freezing temperatures.
  - a. Winterizing
    - i. Install a heating system to maintain air temperatures above 0°C (if tank is indoors).
    - ii. Install a water heating system directly inside the rainwater tank.
    - iii. Install heat trace wire around pipes, valves and/or pump.
    - iv. Install insulation on the rainwater tank, around pipes, valves and/or pump.
  - b. Decommissioning
    - i. Drain all of the rainwater stored in the tank and the rainwater pressure piping.
    - ii. Shut off the water supply to the make-up water system (if present) to prevent the tank from refilling.
    - iii. Disconnect electrical supply to the pump and control equipment.
    - iv. Disconnect downspouts from the conveyance network and have them discharge to grade or other suitable location.
    - v. Disconnect fixtures from rainwater supply and connect to the potable water system.

<sup>7</sup> Key Messages from a Decade of Water Quality Research into Roof Collected Rainwater Supplies. 2006. Coombes, P.J., Dunstan, H., Spinks, A., Evans, C., Harrison, T. in: Proceedings of 1<sup>st</sup> National HYDROPOLIS Conference.



The background of the top section of the page is a close-up photograph of water ripples, showing concentric circles and fine lines on a light blue surface. The text is overlaid on this image.

# Chapter 3

## Rainwater quality and treatment

### 3.1 INTRODUCTION

As precipitation falling from the sky, rainwater is naturally of very high quality. Once this precipitation reaches the earth, however, rainwater comes into contact with a variety of surfaces—grasses and landscapes, bodies of water and anthropogenic surfaces such as roofs and parking lots—that can impart contaminants into the rainwater runoff. Contaminants can also be introduced into rainwater by environmental factors, such as air pollutants from industry and major roadways, and from plants and animal activity.

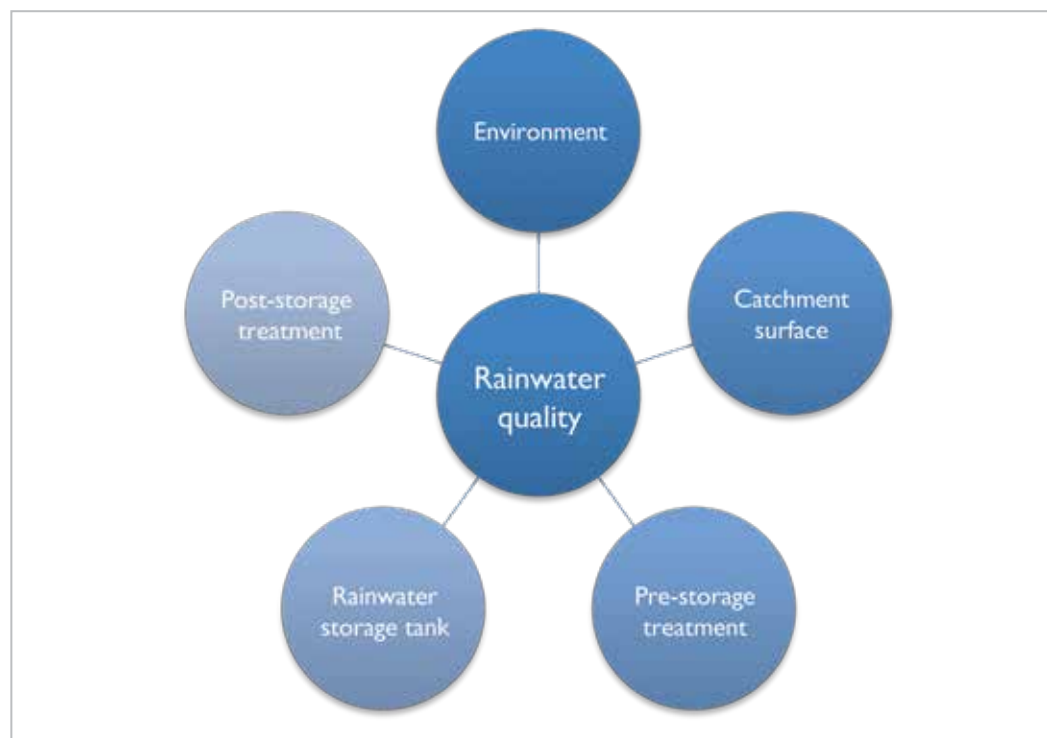

**Figure 3-1** Factors that can affect rainwater quality

The presence of these contaminants can affect the physical, chemical and/or biological properties of water and, if present in sufficient quantities, they can affect the aesthetic quality of water (its colour, taste and odour) and/or produce negative human health impacts. For these reasons, rainwater quality (a measure of its physical, chemical and biological characteristics) is one of the key factors that determine its suitability for a particular use.

This chapter discusses the factors that can affect rainwater quality and provides suggestions on how these risk factors can be mitigated through appropriate design and installation of rainwater harvesting systems, and requisite treatment processes.

## 3.2 APPLICABLE CODES, STANDARDS AND GUIDELINES

Table 3-1 references specific codes and standards that are applicable to the quality of harvested rainwater and required treatment.

**Table 3-1** Applicable standards, codes and guidelines for rainwater quality and treatment

Applicable codes, standards and guidelines	Selected provisions and design and installation implications
<b>National Plumbing Code of Canada (2010)</b>	<ul style="list-style-type: none"> <li>■ <b>2.7.4.1.(2) Non-potable Water System Design</b></li> </ul> <p>Specifies that rainwater may be used to supply water closets, urinals and directly connected underground irrigation systems that only dispense water below the surface of the ground.</p> <p><i>No rainwater and/or non-potable water quality standards or treatment requirements are specified by the 2010 NPC.</i></p>
<b>National Plumbing Code of Canada (2005)</b>	<p><i>N/A – No permitted rainwater uses specified.</i></p> <p><i>No rainwater and/or non-potable water quality standards or treatment requirements are specified by the 2005 NPC.</i></p>
<b>CSA Standard B128.1 (2006)</b>	<ul style="list-style-type: none"> <li>■ <b>8.0 Treatment</b></li> </ul> <p>Specifies that water supplied by an RWH system must be treated to meet the water quality standards specified by public health or other regulatory authorities.</p>
<b>Canadian Guidelines for Domestic Reclaimed Water for Use in Toilet and Urinal Flushing (2010)</b>	<p>Sets out water quality guidelines, water quality testing protocols and management frameworks for domestic reclaimed water use in toilets.</p> <p><i>Note: No quality standard has been set nationally for rainwater use. Canadian Guidelines for Domestic Reclaimed Water for Use in Toilet and Urinal Flushing may be used as a guide for rainwater quality, but its quality requirements exceed those recommended in these Guidelines.</i></p>
<b>NSF Protocol P151 (1995)</b>	<p>Selection of roofing materials, coatings, paints and gutters with NSF P151 certification will not impart levels of contaminants greater than those specified in the U.S. EPA's Drinking Water Regulations. Recommended where high quality rainwater is needed for the intended use.</p> <p><i>Note: Not legally binding unless adopted in future editions of the NPC.</i></p>
<b>NSF/ANSI Standard 61 (2008)</b>	<p>Selection of a plastic tank with NSF/ANSI Standard 61 certification will not introduce unsafe levels of contaminants into drinking water. Recommended where high quality rainwater is needed for the intended use.</p> <p><i>Note: Not legally binding unless adopted in future editions of the NPC.</i></p>

Mandatory documents

Supplementary documents

### 3.3 ISSUES FOR CONSIDERATION

#### **Rainwater quality and treatment guidelines**

---

There are currently no national water quality guidelines that pertain specifically to the use of rainwater. The *Canadian Guidelines for Domestic Reclaimed Water for Use in Toilet and Urinal Flushing* (2010) are not intended for rainwater use, but may be applied for multi-residential or commercial systems where there is the potential for direct contact. For single-family dwellings, the quality of rainwater and the need for treatment must be evaluated in the context of connected fixtures. Connected fixtures where there is minimal contact with the rainwater do not require the same quality of water as applications where users come into direct contact with the water. Treatment needs should be determined on a case by case basis by local building or health authorities, considering the recommendations of designers and preferences of end users.

#### **Factors affecting rainwater quality**

---

##### ***Catchment surface***

Contaminants can be introduced into runoff from the catchment surface in two ways, either by the washing-off of contaminants that have collected on the surface between rainfall events or through the leaching of chemicals and/or metals from the catchment material.

##### ***Storage material***

As with the catchment surface, chemicals and/or metals can leach from the rainwater storage tank material(s) or from the various components located in the tank. The rainwater storage tank can also have beneficial impacts on rainwater quality by providing a reservoir where suspended dirt and debris can settle to the bottom of the tank.

##### ***Environment***

Environmental conditions are largely out of the hands of the designer and/or user of rainwater harvesting systems. Environmental sources of contamination include anthropogenic sources of air pollution like industry and major roadways. Natural sources of contamination include nearby trees and plants, which deposit leaves, pollen, etc., and animals (birds, squirrels), which deposit waste, etc., on the catchment surface.

##### ***Rainwater overflows***

Contaminants can also be introduced into the rainwater storage tank through the overflow-handling method used by the rainwater harvesting system (see *chapter 6. Overflow provisions and stormwater management* for details). If overflows are directed to a municipal storm sewer or an on-site soakaway pit, there is the potential during intense rainfall events for these systems to backflow into the tank, contaminating it

with poor quality water. These overflow-handling systems must be designed properly and preventative measures put in place, to minimize the possibility of storage tank contamination.

## Treatment options

Treatment can be applied to improve rainwater quality and can take place:

- before storage in the rainwater storage tank (pre-storage treatment); and/or
- after storage in the rainwater storage tank (post-storage treatment).

Pre-storage treatment devices must be incorporated as part of the conveyance network and rely on gravity flow to facilitate the treatment process. Post-storage treatment devices tend to be more rigorous than pre-storage treatment devices and often require pressurized flow and/or electricity to aid in the treatment process. The advantages and disadvantages associated with these treatment approaches are summarized in table 3-2.

**Table 3-2** Comparison of advantages and disadvantages associated with pre- and post-storage treatment

Treatment location	Advantages	Disadvantages
<b>Pre-storage treatment</b>	<ul style="list-style-type: none"> <li>■ Simple in design; operates using gravity flow (no electricity or high pressure requirement)</li> <li>■ Prevents large particles from accumulating in the storage tank</li> <li>■ Reduces requirement for post-storage treatment devices (or can preclude their use altogether)</li> </ul>	<ul style="list-style-type: none"> <li>■ Susceptible to freezing</li> <li>■ Requires regular cleaning and maintenance. Poorly maintained devices may prevent rainwater from being conveyed to tank or may permit untreated rainwater to enter the tank</li> <li>■ Multiple collection points may require a number of localized pre-treatment devices, increasing cost</li> </ul>
<b>Post-storage treatment</b>	<ul style="list-style-type: none"> <li>■ Very high quality of water can be achieved</li> <li>■ Located inside building, so no freezing risk</li> <li>■ Can be used to treat more complex quality issues (for example, pine needles in tank that create tannic acid)</li> </ul>	<ul style="list-style-type: none"> <li>■ May require maintenance and replacement of filters, chemicals or other materials</li> <li>■ End quality depends on incoming rainwater quality and maintenance of pre-storage treatment devices</li> <li>■ Generally more expensive than pre-storage treatment</li> </ul>



### ***Pre-storage treatment devices***

Although there are various ways of treating rainwater prior to storage, methods tend to use one of three techniques: first-flush diversion, filtration or settling.

First-flush diversion involves diverting the first portion of runoff (collected from the catchment surface) away from the storage tank. One of the many ways this diversion can take place is depicted in figure 3-2. This technique improves stored rainwater quality by preventing the entry of the dirt and debris that collect on the catchment surface between rainfall events—the majority of which are contained in the first portion of runoff (first flush).

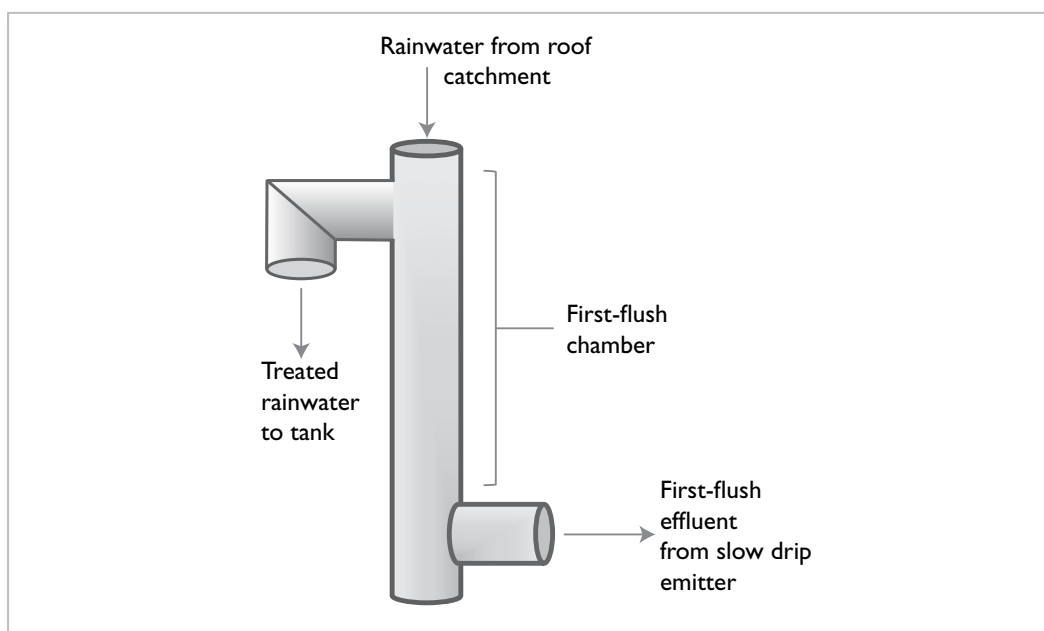

**Figure 3-2** The operation of a first-flush diverter

The second method, filtration, involves screening out leaves and large debris from runoff, preventing their entry into the rainwater storage tank. Filtration can take place at or near the catchment surface in the form of screens placed over gutters (referred to as “gutter guards”) or screens placed over rain leaders on flat-roofed buildings (common on commercial buildings). Filtration devices can also be integrated into downspouts or other parts of the conveyance network. Examples of commercial filtration devices are shown in figure 3-3.

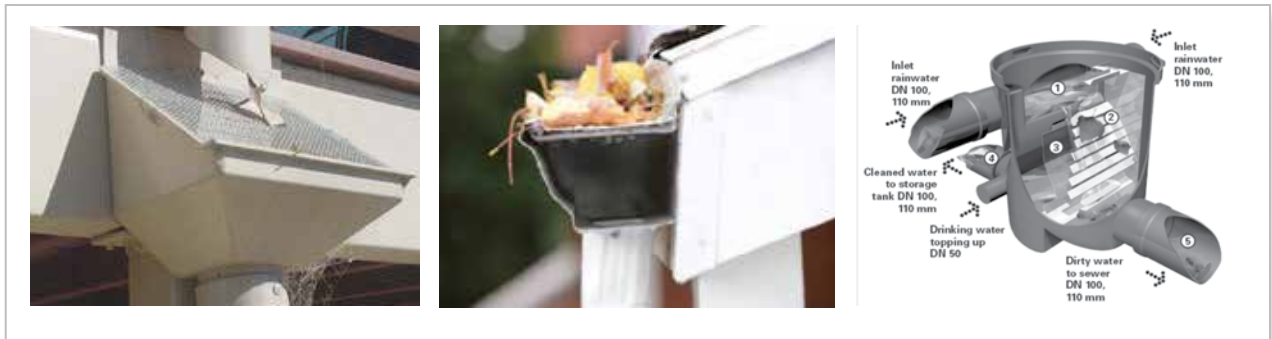

**Figure 3-3** Pre-storage filtration options:  
**Left** Leaf Eater®, **Centre** Alu-Rex Fixa-Tech®, **Right** 3PVFI Filter<sup>8,9,10</sup>

Another pre-storage treatment method is a settling chamber in a rainwater storage tank or a dedicated settling tank. Rainwater from the roof catchment is first conveyed to the settling tank or settling chamber, where the dirt and debris suspended in the rainwater can settle out and collect as sediment at the bottom of the tank or chamber. The treated or 'clarified' water is then conveyed to the rainwater storage tank or the storage chamber of the tank. A two-compartment rainwater storage tank with a settling chamber is depicted in figure 3-4.

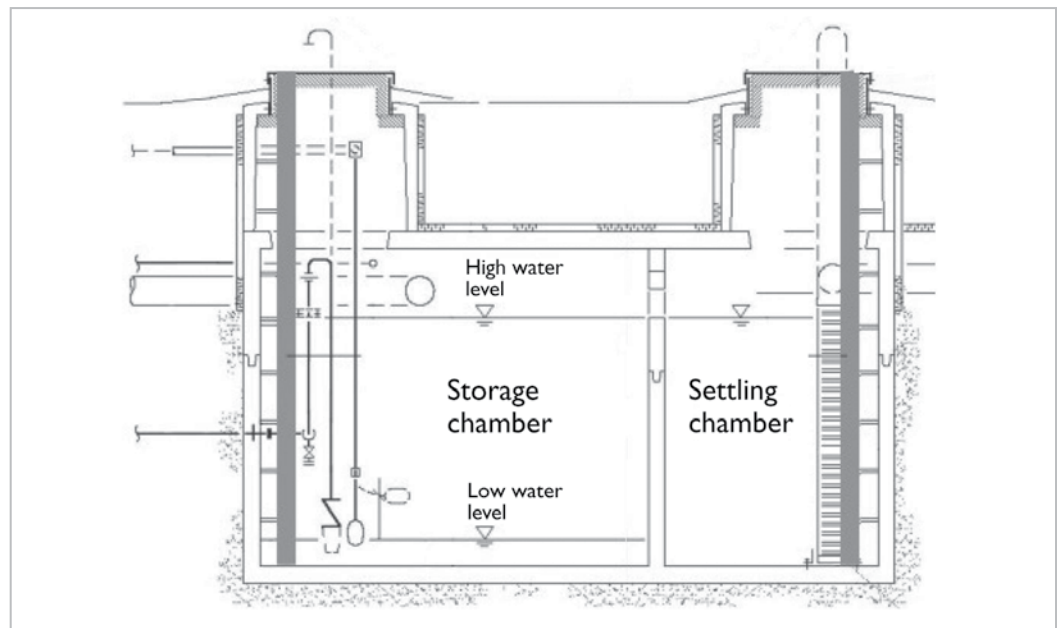

**Figure 3-4** Rainwater storage tank with integrated settling and storage chambers<sup>11</sup>

<sup>8</sup> Image of Leaf Eater® © Rain Harvesting Pty Ltd., Brisbane, Australia.

<sup>9</sup> Image of Alu-Rex Fixa-Tech® © Alu-Rex Inc., Charny, QC.

<sup>10</sup> Image of 3PVFI Filter © 3P Technik Filtersysteme GmbH, Donzdorf, Germany.

<sup>11</sup> Image of tank with settling chamber © Enermodal Engineering Ltd., Kitchener, ON.

### Post-storage treatment devices

Post-storage treatment includes filtration, disinfection and/or treatment for aesthetic issues like colour, taste or odour. As for pre-storage treatment, there are a number of different treatment devices available to perform these tasks. A description of these techniques, their applications and a list of available devices/options are provided in table 3-3. A common form of post-storage treatment is 5 micron particle filtration, followed by ultraviolet (UV) disinfection.

**Table 3-3** Summary of post-storage treatment options

Treatment location	Details	Treatment devices/options available <sup>1</sup>
<b>Filtration</b>	<p>Filtration removes suspended particles from water by passing it through a permeable material.</p> <p><i>Water quality issues targeted:</i></p> <ul style="list-style-type: none"> <li>■ Turbidity</li> <li>■ Total suspended solids</li> </ul>	<ul style="list-style-type: none"> <li>■ Particle filtration (for example, bag/sock or cartridge filter)</li> <li>■ Slow sand filtration</li> <li>■ Membrane filtration</li> </ul>
<b>Disinfection<sup>2</sup></b>	<p>Disinfection removes or inactivates micro-organisms by chemical or physical means.</p> <p><i>Water quality issues targeted:</i></p> <ul style="list-style-type: none"> <li>■ Microbiological contaminants (viruses, bacteria and protozoa)</li> </ul>	<ul style="list-style-type: none"> <li>■ Ultraviolet (UV)</li> <li>■ Chlorine</li> <li>■ Ozonation</li> <li>■ Slow sand filter</li> <li>■ Membrane filtration</li> <li>■ Thermal treatment</li> </ul>
<b>Aesthetic issue treatment</b>	<p>Aesthetic issue treatment removes constituents from water that contribute to colour, taste or odour issues.</p> <p><i>Water quality issues targeted:</i></p> <ul style="list-style-type: none"> <li>■ Hydrogen sulphide</li> <li>■ Organic matter</li> <li>■ Manganese</li> <li>■ Iron</li> </ul>	<ul style="list-style-type: none"> <li>■ Activated carbon</li> <li>■ Ozonation</li> <li>■ Slow sand filter</li> <li>■ Reverse osmosis</li> <li>■ Membrane filtration with chemical addition</li> </ul>

<sup>1</sup> Other treatment options may be available.

<sup>2</sup> All methods will require some level of online monitoring to ensure disinfection is reaching appropriate levels.

## Treatment device selection

---

When determining the treatment devices required for a rainwater harvesting system, the following questions should be considered.

1. What quality requirements do applicable provincial, territorial and/or national codes and regulations specify for the uses under consideration?
2. What applications will the rainwater be used for?
3. Can the rainwater harvesting system supply sufficient quantities of rainwater to meet the desired uses?
4. Can treatment requirements be achieved through the proper design, installation and maintenance of the rainwater harvesting system?
5. What are the personal preferences of those using the rainwater and those who are managing the rainwater harvesting system?
6. What treatment devices are locally available?
7. Are there methods of segregating the rainwater usage in the house or building (that is, supplying rainwater of varying qualities to different fixtures)?
8. What is the waste stream that is going to be generated through treatment? How will it be disposed of?
9. What are the capital, operation and maintenance costs associated with the treatment devices?
10. Who will be responsible for the management of the rainwater harvesting system, and treatment system specifically? (that is, who will ensure that maintenance is performed, provide training to maintenance personnel and pay for the replacement of filters or other components?)

Recommendations on how to address these questions and select the treatment method are provided in *section 3.4 Design and installation guidelines*.

## Performance issues with treatment devices

---

### Losses

Like the roof catchment, pre-storage treatment devices typically reduce the collection efficiency of a rainwater harvesting system. These losses can be quantified using the same measures as were used for the catchment surface—an initial rainfall loss factor and a continuous loss factor. If a pre-storage treatment device is to be incorporated into a rainwater harvesting system, these losses should be considered in addition to catchment surface losses when sizing the storage tank (refer to *chapter 2. Rainwater storage and tank sizing* for details). In general, initial losses are higher for first-flush devices than for filtration devices, while continuous losses are higher for filtration devices than for first-flush devices. Exact losses depend on system design and can be supplied by the manufacturer or supplier.

Collection efficiency losses are not typically found with post-storage treatment devices, although some are associated with a loss in system pressure. These losses, however, are small and can be considered when selecting the pump for the pressure system or often ignored altogether (for further details refer to *chapter 5. Pump and pressurized distribution system*).

### ***Cold weather issues***

Cold weather issues can develop with pre-storage treatment devices since these are often integrated with the outdoor parts of the conveyance network. For example, if ice accumulates in the pre-storage treatment device, it may prevent the flow of snowmelt from the catchment surface during freeze-thaw periods. This ice buildup could eventually damage the pre-treatment device itself or parts of the conveyance network. Because of these issues, the selection and proper maintenance of a pre-storage treatment device appropriate to a cold weather climate is necessary to ensure optimal performance of the RWH system during the winter months.

### 3.4 DESIGN AND INSTALLATION GUIDELINES

- I. Identify factors that impact the quality of rainwater in the rainwater harvesting system, and can be mitigated through proper design and installation (see table 3-4).

**Table 3-4** Factors affecting rainwater quality and recommendations for mitigating rainwater contamination through design and installation best practices

Component of RWH system	Risk factors	Design and installation best practices
<b>Catchment surface</b>	<ul style="list-style-type: none"> <li>■ Overhanging tree branches and animal activity</li> <li>■ Leaching of chemicals and/or metals from catchment material</li> <li>■ Grease and lint on catchment surface from kitchen cooktop vent and dryer vent, respectively</li> <li>■ Proximity to sources of air pollution (industry, major roadways, etc.)</li> </ul>	<ul style="list-style-type: none"> <li>■ Trim overhanging tree branches</li> <li>■ Collect runoff from surfaces with NSF Protocol P151 certification</li> <li>■ Direct dryer and kitchen cooktop vents under gutters</li> <li>■ Do not collect runoff from sections of catchment area at risk for poor quality</li> </ul>
<b>Conveyance network</b>	<ul style="list-style-type: none"> <li>■ Entry of potentially poor quality groundwater/surface water from poorly sealed joints</li> <li>■ Entry of animals and/or insects through poorly sealed joints</li> </ul>	<ul style="list-style-type: none"> <li>■ Ensure underground pipe connections and fittings are secure</li> <li>■ Use downspout-to-PVC pipe adapters</li> </ul>
<b>Rainwater storage tank</b>	<ul style="list-style-type: none"> <li>■ Sediment settled on bottom of tank</li> <li>■ Ingress of insects, rodents or debris</li> <li>■ Algae growth in tank</li> <li>■ Leaching of chemicals and/or metals from tank material or components located inside tank</li> </ul>	<ul style="list-style-type: none"> <li>■ Locate pump intake at a suitable distance above tank floor</li> <li>■ Ensure tank hatch is properly covered and vents have screens</li> <li>■ Prevent entry of direct sunlight into tank</li> <li>■ Store rainwater in tank with NSF/ANSI Standard 61 certification</li> </ul>
<b>Overflow system</b>	<ul style="list-style-type: none"> <li>■ Backflow of storm sewage during extreme rainfall events (if overflow is connected to storm sewer)</li> </ul>	<ul style="list-style-type: none"> <li>■ Ensure overflow system is adequately designed for intense rainfall events and use backwater valve on overflow drainage piping</li> </ul>

**2. Determine rainwater quality and treatment requirements.**

- a. In Canada, the *2010 National Plumbing Code* permits rainwater to be used for:
  - i. toilet and urinal flushing;
  - ii. directly connected underground irrigation systems that dispense water only below the surface of the ground.
- b. Consult the applicable provincial/territorial codes and regulations to verify the fixtures for which connection to rainwater is permitted
- c. Consult the applicable provincial/territorial codes and regulations and local authorities regarding quality and treatment requirements for the permitted rainwater fixtures.
- d. Treatment recommendations (provided for guidance purposes only):
  - i. For typical single-family residential dwellings consult the recommendations in table 3-5.

**Table 3-5 Treatment recommendations for typical single-family residential dwellings**

Rainwater fixtures	Recommended degree of treatment <sup>1</sup>
<b>Toilet and urinal flushing</b>	<ul style="list-style-type: none"> <li>■ Treatment by pre-storage treatment device in addition to the adoption of best practices outlined in table 3-4</li> </ul>
<b>Directly connected underground irrigation system dispensing water below the surface of the ground</b>	<ul style="list-style-type: none"> <li>■ Treatment by pre-storage treatment device in addition to the adoption of best practices outlined in table 3-4</li> <li>■ Treatment by post-storage filtration devices as required by irrigation system manufacturer/contractor</li> </ul>

<sup>1</sup> Note: Recommendations only. Consult applicable provincial/territorial codes and regulations as well as local authorities regarding permitted fixtures, quality targets and required treatment devices.

**3. Select and install pre-storage treatment devices.**

- a. Pre-storage treatment devices must be sized to handle the peak runoff from the catchment surface (refer to *section 1.4 Design and installation guidelines* for further details regarding design rainfall intensity).
- b. Filter frost protection in one of the following ways
  - i. Locate the treatment device in a temperature-controlled environment (maintained above 0°C).
  - ii. Locate the treatment device below the frost penetration depth, or, where burial below the frost penetration depth is not possible, locate the device below ground with appropriate insulation (refer to *Appendix A* for details).
  - iii. Decommission/disconnect the treatment device from the conveyance network and drain the device prior to the onset of cold weather (refer to *section 2.4 Design and installation guidelines* for details).

## c. First-flush diverters

- i. Size the first-flush chamber based on the desired amount of runoff (typical diversion height is 0.5-1.5 mm) to divert from the storage tank, using the following formulas:

$$\mathbf{Diversion\ volume\ (L) = Diversion\ height\ (mm) \times Catchment\ area\ (m^2)}$$

Equation 3-1

$$\mathbf{Height\ of\ first-flush\ chamber\ (mm) = \frac{4 \times Diversion\ volume\ (L) \times 1000}{3.14 \times [Pipe\ diameter\ (mm)]^2}}$$

Equation 3-2

## ii. Estimate the collection losses

1. Initial loss factor – Equal to the Diversion height (mm)
2. Continuous loss factor – Depends on the rate of flow through the slow drip emitter. A 5% continuous loss can be assumed or the continuous loss can be directly measured during a rainfall event.

## d. Settling tank or settling chamber

- i. Size the settling tank or settling chamber based on the temporary storage of a prescribed volume of runoff.
1. Where the prescribed volume can be based on rainfall (for example, 5 mm of rain)<sup>12</sup>, using the following formula:

$$\mathbf{Settling\ tank\ volume\ (L) = Rainfall\ (mm) \times Catchment\ area\ (m^2)}$$

Equation 3-3

2. Where the prescribed volume can be based on a percentage of the rainwater storage tank capacity (for example, settling chambers in two-compartment tanks typically have 1/3 the capacity of the storage chamber).

## e. Pre-storage treatment filtration devices

- i. The following components may be included as part of the filtering system:
1. high quality gutter guards, available from gutter contractors;
  2. leaf screens placed on the downspout, available from gutter contractors; and/or
  3. commercially supplied rainwater filter installed in-line with conveyance drainage pipe, or inside tank.
- ii. Estimate the collection losses.
1. Initial loss factor – Reported by the supplier or can be assumed to be negligible (0 mm)
  2. Continuous loss factor – Reported by the supplier or can be conservatively estimated at 20%

<sup>12</sup> Adapted from Performance Evaluation of a Rainwater Harvesting System. Interim report 2008. Toronto and Region Conservation Authority, Toronto, ON.



- f. Pre-storage treatment devices shall be installed in accordance with applicable provincial/territorial codes and standards and manufacturer's instructions.
- g. Pre-storage treatment devices shall be installed so that they are readily accessible. Access openings to facilitate entry into the device and/or tank shall be in accordance with the guidelines in *section 2.4 Design and installation guidelines*.

**4. When selecting and installing post-storage treatment devices**

- a. Pre-storage treatment devices should also be used to minimize wear on post-storage treatment devices.
- b. Post-storage treatment devices shall be sized in accordance with the maximum flow rate of the pressure system and manufacturer's requirements.
- c. Post-storage treatment devices shall be installed in accordance with applicable provincial/territorial codes and standards and manufacturer's instructions.
- d. Post-storage treatment devices shall be installed so that they are readily accessible.

### 3.5 MANAGEMENT GUIDELINES

- I. Identify the factors that can impact the quality of rainwater in the RWH system and take steps to mitigate the risks posed by these factors by implementing the following maintenance activities:
  - a. Consult the maintenance best practices provided in table 3-6.

**Table 3-6** Factors affecting rainwater quality and recommendations for mitigating rainwater contamination through maintenance best practices<sup>13</sup>

Component of RWH system	Risk factors	Maintenance best practices
<b>Catchment surface</b>	<ul style="list-style-type: none"> <li>■ Proximity to sources of air pollution (industry, major roadways, etc.)</li> <li>■ Overhanging tree branches</li> <li>■ Animal activity</li> <li>■ Leaching of chemicals and/or metals from catchment material</li> </ul>	<p>At least once every 6 months:</p> <ul style="list-style-type: none"> <li>■ inspect catchment surface for sources of contamination (accumulated debris, leaves, pine needles, etc.) and clean area; and</li> <li>■ trim overhanging tree branches.</li> </ul>
<b>Conveyance network</b>	<ul style="list-style-type: none"> <li>■ Entry of potentially poor quality groundwater/surface water through poorly sealed joints</li> <li>■ Entry of animals and/or insects through poorly sealed joints</li> </ul>	<p>At least once every 6 months:</p> <ul style="list-style-type: none"> <li>■ inspect gutters for sources of contamination (accumulated debris, leaves, pine needles, etc.) and clean gutters as required;</li> <li>■ inspect area(s) where downspouts connect to conveyance network to ensure fittings are secure; and</li> <li>■ inspect pre-storage treatment devices connected to conveyance network and clean devices as required.</li> </ul>
<b>Rainwater storage tank</b>	<ul style="list-style-type: none"> <li>■ Leaching of chemicals and/or metals from rainwater storage tank material</li> <li>■ Leaching of chemicals and/or metals from components located in rainwater tank</li> <li>■ Pump intake located at bottom of tank where it can draw in sediment</li> </ul>	<p>At least once annually:</p> <ul style="list-style-type: none"> <li>■ inspect components inside tank for signs of corrosion and/or degradation and replace components as necessary; and</li> <li>■ monitor rainwater quality at point-of-use for indications of sediment accumulation in tank.</li> </ul>

<sup>13</sup> Adapted from CSA B128.1-06/B128.2-06, Design and installation of non-potable water systems/Maintenance and field testing of non-potable water systems. 2006. CSA International, Toronto, ON.

- b. Consider other site-specific risk factors and adapt maintenance of the RWH system as appropriate to mitigate the risks to rainwater quality.
- 2. Pre-storage treatment devices should be inspected at least twice a year, or more frequently as required by manufacturer's instructions and site conditions.**
  - a. Observe rainwater passing through the devices during a rainfall event, or simulate a rainfall event by discharging water from a hose onto the catchment surface. Look for potential problems such as:
    - i. accumulated dirt and debris blocking flow through filter;
    - ii. loose fittings or other problems with the treatment devices such that rainwater is passing through without treatment taking place; or
    - iii. other problems with the treatment devices.
  - b. Clean the filtration devices according to the manufacturer's maintenance instructions, repair as required.
- 3. If pre-storage treatment devices need to be decommissioned during the winter:**
  - a. drain all of the rainwater accumulated in the treatment devices;
  - b. disconnect the treatment devices from the conveyance network; and/or
  - c. install pipe, downspout or other material to bypass the pre-storage treatment devices and direct untreated water to the tank.
- 4. Post-storage treatment devices should be inspected at least quarterly, or more frequently depending on manufacturer's instructions and site conditions.**
  - a. Observe the devices as water flows through the pressure system, looking for problems such as:
    - i. water leaking from treatment devices; or
    - ii. warning/indicator lights on treatment devices indicating fault with device and/or required replacement of components.
  - b. Maintain post-storage treatment devices as necessary through the regular cleaning of filtration devices and/or replacement of filter media, lamps or other components as specified by the product manufacturers.
- 5. While inspecting, cleaning or repairing the pre-storage treatment and/or post-storage treatment devices or other components of the rainwater harvesting system, follow all necessary safety precautions.**

The background of the top section of the slide is a close-up photograph of water with numerous ripples, creating a textured, blue and white pattern. The ripples are concentric circles of varying sizes, suggesting raindrops or a similar disturbance on a water surface.

# Chapter 4

## Make-up water system and backflow prevention

## 4.1 INTRODUCTION

Regardless of the size of the rainwater storage tank or the catchment area, there will occasionally be times when there is insufficient rainfall to meet the demands placed on the RWH system, and the storage tank will run dry. RWH systems need to have a system in place to sense when there is insufficient rainwater and either trigger a warning light or switch to an alternative water supply. This system is often referred to as a “make-up” or “back-up” system.

The primary concern with a make-up system is that it requires water of high quality (from a municipal or private water source) to be brought into close proximity with rainwater, typically of poorer quality. In such situations, there is a risk of a cross-connection. If a connection is made between the RWH system and a municipal water system, there is a risk that rainwater can be drawn into the potable water system by backflow.

Given these concerns regarding cross-connections and backflow, care must be taken when implementing and managing a make-up water system. This chapter provides an overview of the various components that comprise a make-up system and gives guidance on how to assess and then mitigate the risks associated with cross-connection and backflow.

Note: Proper design, installation and management must also extend to the entire rainwater pressure system, since a cross-connection can potentially exist at any point in the system. Refer to *chapter 5. Pump and pressurized distribution system* for further details.

## 4.2 APPLICABLE CODES, STANDARDS AND GUIDELINES

Table 4-1 references specific codes and standards that are applicable to make-up water systems and backflow prevention.

**Table 4-1** Applicable standards, codes and guidelines for make-up water systems and backflow prevention

Applicable codes, standards and guidelines	Selected provisions and design and installation implications
<p><b>National Plumbing Code of Canada (2010) and (2005)</b></p>	<ul style="list-style-type: none"> <li>■ <b>2.2.10.15. Water Hammer Arresters</b></li> <li>■ <b>2.6.1.11. Thermal Expansion</b></li> <li>■ <b>2.6.2.1.(3) Connection of Systems</b></li> <li>■ <b>2.6.2.6. Premise Isolation</b></li> <li>■ <b>2.6.2.9. Air Gap</b></li> <li>■ <b>2.7.1.1. Not Permitted</b></li> </ul> <p>Article 2.7.1.1. specifies that an RWH system (non-potable water system) shall not be connected to a potable water system. The potable water system shall be protected by means of an air gap (2.6.2.9.) for top-up systems. Sentence 2.6.2.1.(3) specifies that backflow preventers be selected in accordance with:</p> <ol style="list-style-type: none"> <li>1. CAN/CSA Standard B64.10.01 (2001) – 2005 NPC</li> <li>2. CSA Standard B64.10-07 (2007) – 2010 NPC</li> </ol> <p>Article 2.6.2.6. provides additional backflow prevention requirements for the purpose of premise isolation.</p> <p>When backflow prevention devices are installed, thermal expansion tanks must also be installed as per article 2.6.1.11. When a solenoid valve is installed for a top-up system, a water hammer arrester may be required in accordance with article 2.2.10.15.</p>
<p><b>CSA Standard B64.10 (2007)</b></p> <p><b>[Referenced by the 2010 edition of the National Plumbing Code]</b></p>	<ul style="list-style-type: none"> <li>■ <b>Appendix B, table B1</b></li> <li>■ <b>5.3.4.3(a) Premise isolation</b></li> </ul> <p>Specifies that a dual check valve (DuC) shall be used to isolate a residential premise with access to an auxiliary water supply (the RWH system), if there is no direct connection between the auxiliary water supply and the potable supply.</p> <p><i>Note: Sentence 5.3.4.3(a) of CSA B64.10 contravenes article 2.6.2.6. of the NPC. Furthermore, CSA B64.10 permits cross-connections where adequate backflow prevention is provided; however, article 2.7.1.1. of the NPC prohibits such connections. In cases of conflict between a referenced document and the NPC, the NPC provision prevails.</i></p>

Applicable codes, standards and guidelines	Selected provisions and design and installation implications
<p><b>CAN/CSA Standard B64.10 (2001)</b> <b>[Referenced by the 2005 edition of the National Plumbing Code]</b></p>	<ul style="list-style-type: none"> <li>■ <b>Appendix B, table B1</b></li> <li>■ <b>4.3.4.2 Premise isolation</b></li> </ul> <p>Specifies that, where a potential connection exists between the RWH system (non-potable water system) and potable water system, it must be protected by means of an air gap or reduced pressure (RP) backflow prevention device. Buildings with an RWH system (rated as a severe hazard classification) must provide premise isolation by means of a reduced pressure (RP) backflow preventer.</p> <p><i>Note: CSA B64.10 permits cross-connections where adequate backflow prevention is provided; however, article 2.7.1.1. of the NPC prohibits such connections. In cases of conflict between a referenced document and the NPC, the NPC provision prevails.</i></p>
<p><b>Canadian Electrical Code (Current ed.)</b></p>	<ul style="list-style-type: none"> <li>■ <b>All electrical equipment must be approved and installed according to the requirements of the current edition of the <i>Canadian Electrical Code</i>.</b></li> </ul>
<p><b>CSA Standard B128.1 (2006)</b></p>	<ul style="list-style-type: none"> <li>■ <b>6.0 Backflow prevention</b></li> <li>■ <b>11.2 Cross-connection testing</b></li> </ul> <p>Specifies that backflow prevention devices shall comply with CAN/CSA-B64.10 and the <i>National Plumbing Code</i> or the applicable provincial/territorial plumbing code. Section 11.2 provides guidelines for cross-connection testing after installation.</p>

Mandatory documents

Supplementary documents

### 4.3 ISSUES FOR CONSIDERATION

#### Types of make-up water systems

To ensure that rainwater demands are met during times when there is insufficient rainfall and the tank runs dry, there are two general options available:

- 1. Top-up** – The rainwater storage tank can be partially filled, either manually or automatically, with make-up supplies of water from municipal (potable) or private water sources
- 2. Bypass** – The rainwater supply from the pressure system can be shut off, either manually or automatically, and water from municipal or private sources can be directed through the rainwater pressure piping.

Of these options, only top-up systems are permitted by the *National Plumbing Code*. The bypass method contravenes subsection 2.7.1, of the Code, which states that “a non-potable water system shall not be connected to a potable water system.”<sup>14</sup> Consequently, this chapter focuses on top-up based make-up systems. Advantages and disadvantages associated with the manual and automatic top-up systems are discussed in table 4-2.

**Table 4-2** Advantages and disadvantages associated with top-up methods

Make-up water method	Advantages	Disadvantages <sup>1</sup>
<b>Manual top-up</b>	<ul style="list-style-type: none"> <li>■ Simplest method to design and install due to reduced control equipment requirements</li> <li>■ Lowest cost alternative</li> </ul>	<ul style="list-style-type: none"> <li>■ May result in service interruptions (for example, no water for flushing toilets) if tank not topped up prior to going dry</li> <li>■ Requires homeowner to monitor volume of stored rainwater in tank and top up pre-emptively if low</li> </ul>
<b>Automatic top-up</b>	<ul style="list-style-type: none"> <li>■ Reduces the number of service interruptions by automatically filling tank before it runs dry</li> <li>■ Make-up system operates without the need for monitoring or intervention by the homeowner</li> </ul>	<ul style="list-style-type: none"> <li>■ Improper design or installation of control equipment may cause insufficient or excessive top-up volumes to be dispensed by the make-up system</li> <li>■ Service interruption during power failure</li> </ul>

<sup>1</sup> Note: Improper design, installation and/or management of all make-up systems may result in risk of cross-connection with the potable water supply.

<sup>14</sup> National Plumbing Code of Canada, 2010. National Research Council of Canada, Ottawa, ON.



For the majority of residential applications, it is recommended that the automatic top-up be selected as it minimizes service interruptions and is the least onerous for the homeowner. An automatic top-up system is depicted in figure 4-1 and the various components are described below.

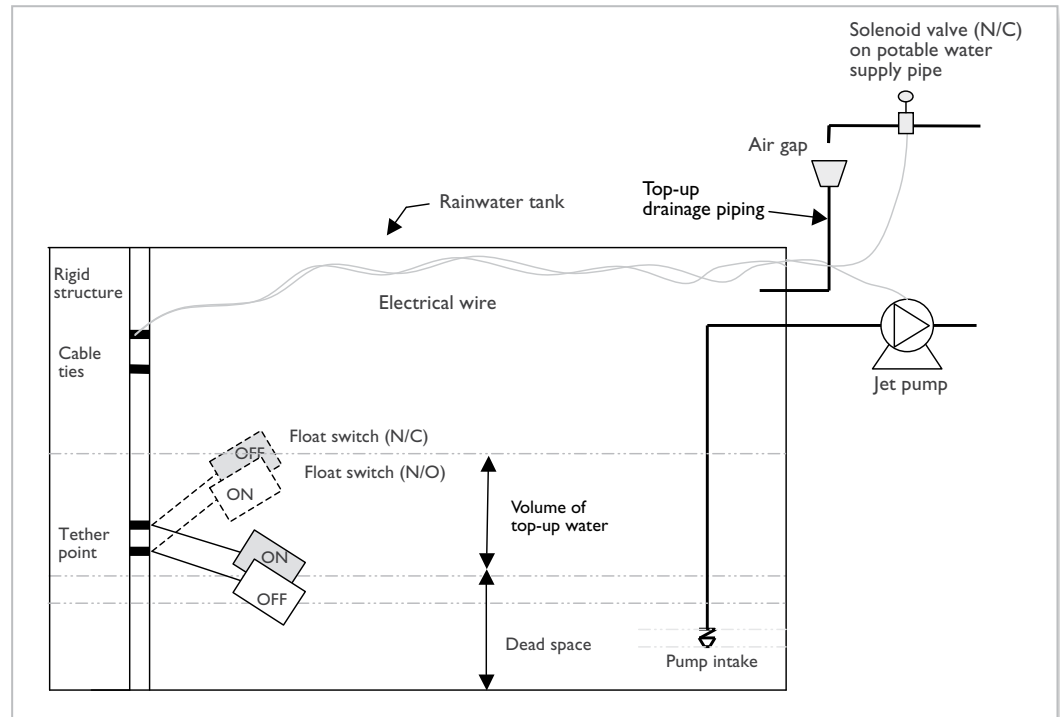

**Figure 4-1** Components of an automatic top-up system

## Control equipment

The control equipment used to construct a make-up water system is listed in table 4-3.

**Table 4-3** Control equipment for make-up water systems

Control equipment	Description	Devices/options available
<b>Water level sensor</b>	<ul style="list-style-type: none"> <li>▪ A device inside the tank is used to sense water level</li> <li>▪ Can control (turn on or off) warning lights, solenoid valves and/or pumps, based on water level</li> </ul>	<ul style="list-style-type: none"> <li>▪ Float switch</li> <li>▪ Ultrasonic level sensor</li> <li>▪ Liquid level switch</li> </ul> <p>(Float switch is typically used for residential applications).</p>
<b>Shut-off valve</b>	<ul style="list-style-type: none"> <li>▪ A device that is manually opened (or closed) to permit (or prevent) the flow of water</li> <li>▪ Integrated into the RWH pressure system to manage waterflow and isolate components of the make-up system (for example, solenoid valves and backflow preventers)</li> </ul>	<ul style="list-style-type: none"> <li>▪ Types: ball valves, gate valves</li> </ul> <p>Shut-off valves selected must be approved for handling water under pressure.</p>
<b>Solenoid valve (automated shut-off valve)</b>	<ul style="list-style-type: none"> <li>▪ A valve that activates (opens or closes) automatically when turned on</li> <li>▪ Connected to water level sensor to activate make-up water system</li> </ul>	<ul style="list-style-type: none"> <li>▪ Come in a variety of configurations</li> </ul> <p>The solenoid valves selected must be approved for handling water under pressure</p>

When selecting control equipment for the make-up system, the following issues must be considered.

### Sizing

All control equipment must be appropriately sized. Of particular concern for top-up based systems is the sizing of the top-up drainage piping. This pipe must be sized according to gravity flow, not pressurized flow, to prevent water backing up the pipe. In addition, all valves and backflow preventers must also be sized to be the same diameter as the pipes to which they are connected.

### Electrical

Many of the make-up water system control components require an electrical supply to operate. When designing the electrical system for the RWH system, the following must be taken into consideration:

- the operating voltage (120 or 240V) of the pump, solenoid valve and other relevant components;
- the power requirements (in watts or horsepower) of the pump, solenoid valve and other relevant components;
- power rating for float switches and electrical wiring; and
- all equipment must be certified and installed in accordance with the current edition of the *Canadian Electrical Code*.

Many water level sensors (such as float switches) must be rated to handle the power of the device they are controlling. For instance, if a float switch controls a solenoid valve or a pump, it must be rated to handle the power needed to operate the valve or the pump.

### Operating state of float switches and solenoid valves

Both float switches and solenoid valves act like a typical light switch (that is, on or off, open or closed); however, they differ in that these actions can take place whether power is connected or not. To differentiate between these two operating conditions, the terms “normally open” (N/O) and “normally closed” (N/C) are used, as described in table 4-4.

**Table 4-4** Differences between “normally closed” and “normally open” float switches and solenoid valves

Control equipment	Normally closed (N/C)	Normally open (N/O)
<b>Float switch</b>	Supplies power (turns things “on”) when the switch is in the “down” position (when the water level in the tank is high)	Supplies power (turns things “on”) when the switch is in the “up” position (when the water level is below the float switch)
<b>Solenoid valve</b>	When power is on, the valve is “open” and permits the flow of water. Valve closes when power is off.	When power is on, the valve is “closed” and prevents the flow of water. Valve opens when power is off.

Float switches detect the level of rainwater in the tank and automatically trigger an action when levels are below or above a predetermined set point. This may include opening a valve, activating a warning light or shutting off a pump. Float switches must be installed directly inside the storage tank, with the electrical cord tied to rigid material such as a pipe so that the float can pivot up or down from a “tether point” (refer to figure 4-1).

In a top-up system, an N/C switch is used in conjunction with an N/C solenoid valve. When in the down position, the float switch electrifies the solenoid valve, causing it to open and top up the tank with water from the potable water system. The volume of make-up water used is dependent on the “tether length” of the float switch (illustrated in figure 4-1), with longer tether lengths requiring greater make-up volumes before the use of rainwater resumes. The tether point sets the height (liquid level) at which this process takes place, with higher tether points initiating this process earlier (and leaving more unused rainwater, or “dead space,” at the bottom of the tank). To maximize rainwater use, the tether length should be as short as possible and the tether point should be as low as possible, while providing enough water for the pump.

This system theoretically provides dry run protection because the pump intake is located below the low water level (down position of the switch). Dry running occurs when the pump attempts to operate when there is insufficient rainwater in the tank, and can cause the pump to overheat and get damaged. However, if the float switch controlling the solenoid valve fails, or if insufficient make-up water is available, dry running may still occur. A second float switch (N/O) should be connected to the pump and located below the N/C float switch, to shut off the pump and ensure dry run protection in these cases. Similarly, an N/O switch should be used to shut off the pump where a manual top-up system is in place, as there is the likelihood that the storage tank will run dry before make-up water is supplied.

Some pumps may have built-in dry run protection; however, this protection is not appropriate for RWH systems if it is based on a timer, not water level.

### **Cross-connections, backflow prevention and premise isolation**

---

With RWH systems, the risk of cross-connection is highest at the make-up system, as it requires that water from a potable water system be brought into close proximity with non-potable rainwater:

A cross-connection is defined as “any actual or *potential* connection between a potable water system and any source of pollution or contamination”<sup>15</sup> (emphasis added). If a connection is made between the rainwater pressure piping and the potable water system, backflow<sup>16</sup> may occur if pressure in the rainwater pressure piping is too high and/or the pressure in the potable water system is too low. Rainwater may unintentionally be drawn into the potable water supply of the house or building or into the entire water supply system of a municipality, and be used to meet potable water applications.

<sup>15</sup> CAN/CSA-B64.10-07/B64.10.1-07. Selection and Installation of Backflow Preventers/Maintenance and Field Testing of Backflow Preventers. 2007. CSA International, Toronto, ON.

<sup>16</sup> Backflow is defined as “a flowing back or reversal of the normal direction of flow.” CAN/CSA-B64.10-07/B64.10.1-07. Selection and Installation of Backflow Preventers/Maintenance and Field Testing of Backflow Preventers. 2007. CSA International, Toronto, ON.

Because of these risks, both to the individuals in the home or building, and the residents of the municipality, backflow prevention measures are applied on two distinct levels:

- **Zone protection** – Backflow prevention device is installed at the point of an actual cross-connection to protect residents of the building from backflow.
- **Premise isolation** – Backflow prevention device is installed on the potable water piping entering a building, in case zone protection fails or in case of a future unintentional or clandestine cross-connection. Serves to protect users of the municipal system from backflow.

In the case of RWH systems, zone protection is required for the make-up system and premise isolation is required for the building. Numerous devices exist to provide backflow prevention. The *National Plumbing Code* prohibits any direct connection between a potable and a non-potable system and therefore an air gap is required for zone protection of the top-up system. Pursuant to CAN/CSA-B64.10-07, premise isolation may be provided by a dual check valve, if there is no direct connection between the RWH system and the potable water system. All applicable provincial/territorial codes and regulations as well as municipal bylaws must be consulted to determine what degree of backflow prevention is required (refer to section 4.2 *Applicable codes, standards and guidelines* for details).

In addition to these backflow prevention measures, other requirements to reduce the potential for cross-connections include the separation of potable and non-potable pipes and the labelling of non-potable plumbing pipes (refer to chapter 5. *Pump and pressurized distribution system* for details).

## Air gap

The typical method of backflow prevention used for top-up systems is the air gap. An air gap is one of the simplest methods of preventing backflow, and involves a physical separation between two sections of pipe that is open to the atmosphere (shown in figure 4-1 and figure 4-2).

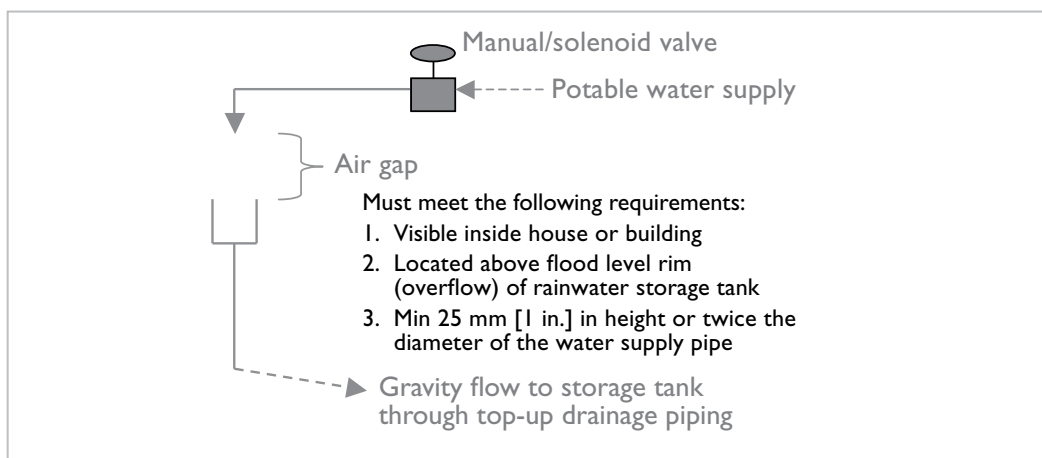

**Figure 4-2** Top-up system with an air gap<sup>17</sup>

<sup>17</sup> Adapted from National Plumbing Code of Canada, 2010. National Research Council of Canada, Ottawa, ON.

This physical break prevents the backflow of water since, even if rainwater backed up from the tank to the gap, it would spill from the gap and not come into contact with the potable water supply. The air gap must be located higher than the overflow drainage piping from the tank and the overflow drainage piping must remain free of blockage so that excess rainwater flows to the overflow system and does not back up and overflow at the air gap.

## 4.4 DESIGN AND INSTALLATION GUIDELINES

### 1. Determine the type of make-up system

- a. Automatic top-up system (recommended)
- b. Manual top-up system
- c. No make-up system (not recommended)

### 2. Plan the layout of the top-up system:

- a. A top-up system is generally composed of the following:
  - i. water level sensors located in the rainwater storage tank;
  - ii. a solenoid valve located on the potable water supply pipe;
  - iii. an air gap;
  - iv. top-up drainage piping conveying make-up water to the rainwater storage tank; and
  - v. electrical conduits containing wiring from water level sensors and pumps.
- b. Determine the location of the solenoid valve and air gap in accordance with the guidelines provided below.
- c. Plan route of top-up drainage piping from the air gap to the tank (refer to *section 1.4 Design and installation guidelines* for guidelines and applicable provincial/territorial codes and regulations regarding drainage piping).
- d. Plan route of electrical conduits from the location of the solenoid valve and power supply to the tank (refer to *section 1.4 Design and installation guidelines* for piping installation guidelines).
- e. Contact the municipality and service providers to ensure that there are no buried service lines (gas, electricity, water, stormwater, wastewater, phone or cable lines) in the area where digging will take place to accommodate the buried top-up drainage piping and/or the electrical conduit.

### 3. Water level sensors

- a. Select the appropriate water level sensors for the RWH system (float switch, ultrasonic level sensor or other).
- b. Float switches
  - i. Select the type of float switch.
    1. Solenoid valve actuation is typically provided by an N/C float switch, for top-up systems.
    2. Pump dry run protection is typically provided by an N/O float switch.

**ii. Electrical requirements**

1. The voltage rating of the float switch must match that of the device it controls (120 V or 240 V).
2. The power rating (watts [W] or horsepower [HP]) of the float switch must be sufficient to carry the total load of the device it controls or, alternatively, float switches may be low voltage and used to activate the pump through relays in a control panel.
3. Spliced electrical wiring must be watertight and its electrical rating is determined by the loads handled by the float switch and the total length of wiring.
4. All electrical connections for float switches must be made by a licensed electrician in accordance with the manufacturer's instructions.

**c. Float switch installation**

- i. The float switch shall be tethered to a rigid freestanding object, such as a vertical section of pipe or the pump, that:
  1. permits the float switch to rise and fall without any obstructions; and
  2. is located in an area where it is easily accessible and can be withdrawn from the tank without requiring entry into the tank.
- ii. To set the operating parameters of the float switch:
  1. to maximize rainwater collection, the tether length should be as short as possible: 75 mm [3 in.]. Refer to the manufacturer's installation instructions for details;
  2. to maximize rainwater collection, the tether point should be as low as possible (so that the float is 50 mm [2 in.] above the pump intake when in the down position); and
  3. If using a dual float switch configuration, the float switch controlling the solenoid valve should be located a minimum of 75 mm [3 in.] above the float switch controlling the pump.
- d. Other water level sensors shall be selected and installed in accordance with applicable provincial/territorial codes and regulations, and all electrical connections must be made by a licensed electrician in accordance with the manufacturer's instructions.

**4. Solenoid valves and shut-off valves**

- a. Select the type and size of solenoid valve and/or shut-off valve.
  - i. All valves must be suitable for potable water and pressure applications.
  - ii. Valve openings must be the same size as the piping where the valves are located.
  - iii. Top-up systems typically use an N/C solenoid valve.
  - iv. Solenoid valves with a 'slow close' or 'soft close' are recommended.
- b. Electrical requirements
  - i. Solenoid valves must be wired into a power supply in conjunction with a water level sensor.
- c. Solenoid valve and shut-off valve installation
  - i. Solenoid valves and shut-off valves used as part of a top-up system shall be installed on the potable water supply pipe upstream of the air gap.
  - ii. Solenoid valves must be installed by a licensed plumber and electrician in accordance with the manufacturer's instructions.
- d. Water hammer protection
  - i. If a 'slow close' or 'soft close' solenoid valve is not used, a water hammer arrester shall be installed on the potable water supply piping upstream of the solenoid valve, in accordance with applicable provincial/territorial codes and regulations.

## 5. Air gap

- a. An air gap is required as part of a top-up system for backflow prevention (zone protection).
- b. Air gaps shall be designed and installed in accordance with applicable provincial/territorial codes and regulations. For guidance purposes only, the following guidelines are provided.
  - i. The gap must be unobstructed – mechanical supports, fixing the potable water supply pipe to the top-up drainage pipe or other components located at or between the potable water supply pipe and the top-up drainage pipe, are not permitted.
  - ii. The air gap must be located in an area where it can be observed and inspected.
  - iii. The air gap must be installed at a height above the flood level rim (overflow) of the rainwater storage tank. If not, there is a risk that rainwater will back up in the top-up drainage pipe and overflow from the air gap.
  - iv. The air gap height must be at least 25 mm [1 in.] or twice the diameter of the water supply pipe.
- c. Splash and water damage prevention
  - i. To prevent make-up water from splashing at the air gap, install the following:
    1. flow restrictor, installed upstream of the solenoid valve; and/or
    2. aerator, installed where the potable water supply pipe terminates; and/or
    3. extended length of vertical pipe with the end of the pipe cut at an angle no less than 45° (to produce laminar flow), installed where the potable water supply pipe terminates above the air gap.
  - ii. To prevent water damage to rooms where the air gap is located:
    1. locate air gaps near a floor drain;
    2. install an overflow on the top-up drainage pipe, located downstream of the air gap, to direct excess make-up water to the sanitary sewer (where permitted by local authorities); and
    3. appropriately size and slope the top-up of the drainage piping.
- d. Make-up water flow rate
  - i. To ensure RWH system operation during top-up, the following measures are recommended:
    1. the flow rate of make-up water should be equivalent to that of the maximum flow rate of the rainwater supply pump; or
    2. the water level sensor(s) should be configured to provide a sufficient reserve volume in the rainwater storage tank (where said reserve volume shall be equivalent to that of the average daily rainwater demand for the RWH system).

## 6. Top-up drainage pipes

- a. Pipe material
  - i. ABS pipe is recommended.
  - ii. Pipe selected must be approved by the applicable provincial/territorial codes and regulations, and industry standards (CSA, ASTM, etc.).



**b. Pipe size and slope**

- i.** Top-up drainage piping shall be sized to handle the maximum flow rate of make-up water discharged at the air gap.
  - ii.** For a typical single-family residential dwelling (provided for guidance purposes only):
    - I.** top-up drainage piping shall be no less than 50 mm [2 in.] in size when served by a potable water supply pipe no more than 18 mm [3/4 in.] in size.
  - iii.** A minimum slope of 0.5-2% (the greater the slope the better) must be maintained throughout the pipe length.
- c.** Consult the applicable provincial/territorial codes and regulations pertaining to the installation of drainage piping (refer to *section 1.2 Applicable codes, standards and guidelines* for details).

**7. Premise isolation**

- a.** Backflow preventers must be installed for the purpose of premise isolation. The following guidelines are based on CSA-B64.10-07, the referenced document in the *2010 National Plumbing Code*. Please note that this edition of the CSA standard is not referenced in the *2005 National Plumbing Code* (refer to *section 4.2 Applicable codes, standards and guidelines* for further details);
- b.** Backflow preventer selection
  - i.** Residential premises with access to an auxiliary water supply (not directly connected) shall be isolated from the potable water supply by a dual check valve (DuC) backflow preventer:<sup>18</sup>
  - ii.** All other premises with access to an auxiliary water supply (including residential premises with a direct connection) must be isolated from the potable water supply by a reduced pressure principal (RP) backflow preventer. A double check valve assembly (DCVA) may be permitted. Consult municipal bylaws and local building officials.
- c.** Protection against thermal expansion
  - i.** If a backflow preventer is installed for premise isolation, the building potable water supply piping must be protected from thermal expansion by installation of an appropriately sized diaphragm expansion tank, selected and installed in accordance with applicable provincial/territorial codes and regulations.
- d.** Backflow preventer testing and maintenance
  - i.** Backflow preventers shall be tested and maintained in accordance with CAN/CSA-B64.10.1-07 Maintenance and Field Testing of Backflow Preventers.

**8. Electrical wiring**

- a.** All electrical wiring must be installed in accordance with applicable provincial/territorial codes and regulations, including the current edition of the *Canadian Electrical Code*.

**9. Electrical conduit and rainwater service conduit**

- a.** Wiring located underground shall be provided with mechanical protection by means of an electrical conduit, or other approved means.
- b.** To facilitate repair and/or replacement of underground rainwater pressure piping, piping should be installed inside a rainwater service conduit, where the conduit material can be flexible drainage tubing (typically referred to as “Big O” tubing) or any other suitable material.

---

<sup>18</sup> Note: Use of a DuC for premise isolation in residential premises (as specified in Subsection 5.3.4. of CSA B64.10) contravenes article 2.6.2.6. of the NPC, which specifies that a reduced pressure principal (RP) backflow preventer is required. In cases of conflict between a referenced document and the NPC, the NPC provision prevails. However, for residential RWH systems not directly connected, a DuC for premise isolation is recommended.

## 4.5 MANAGEMENT GUIDELINES

- I. **Following the installation of the RWH system, if the make-up system does not operate, or if it operates when it should not (for example, tops-up the tank when there is a sufficient quantity of rainwater in the tank):**
  - a. ensure that the proper control equipment was selected and arranged in accordance with the Design and installation guidelines provided;
  - b. visually examine the RWH system—in particular:
    - i. examine the volume of rainwater in the storage tank. if there is sufficient rainwater in the tank, the make-up system should not operate and the fact that it is “off” may indicate that it is functioning as intended,
    - ii. examine the electrical supply to the rainwater pump, solenoid valves, and water level sensors to verify that electricity is being supplied to all equipment,
    - iii. examine the potable water supply pipe to verify that water flow is not being restricted by closed shut-off valves.
  - c. If the above steps do not resolve the problems with the make-up system, its performance must be verified as follows (*Note: this method assumes that a float switch is the water level sensor being used and must be modified for other types of water level sensors using the manufacturer’s troubleshooting instructions*):
    - i. Float switch performance
      1. Visually examine the float switches in the rainwater tank to ensure that:
        - a. they are properly tethered at the appropriate height and can move up and down freely;
        - b. they are not tangled with the pump or other components located in the tank; and
        - c. any electrical splicing of the float switch wire is intact.
      2. Adjust and untangle the float switches if required.
      3. Remove the float switches and the structure to which they are tethered from the rainwater tank, in order to test their performance.
      4. If two float switches are present, the float switch at the lowest elevation should control the rainwater pump (preventing dry running) and the other switch, at a higher elevation, should control solenoid valves for a make-up system.
      5. Simulate a low level event by holding the top float switch in the down position.
      6. For top-up systems, the flow of make-up water should start, which can be observed through an air gap or the storage tank lid/access hatch.
      7. Next, simulate a high level event by holding the top float switch in the up position.
      8. For top-up systems, the flow of make-up water should stop (as observed through an air gap or by the discontinuation of flow into the storage tank).
      9. If another float switch is present in the tank, one which should control the pump in the event of low tank levels, this float switch should also be tested using the above method.
      10. If the make-up system is not operating as intended, then the problem lies in the type of float switches selected. If an N/O float switch is currently installed, then it must be replaced with an N/C float switch, and an N/C float switch must be replaced with an N/O float switch.
      11. If no action is observed in either the float switch up or float switch down scenario, have the RWH system inspected by a licensed plumber and/or electrician.

ii. Solenoid valve performance

1. Visually examine the solenoid valves on the potable water supply pipe and/or rainwater pressure piping. Ensure that each valve is connected to a power supply (electrical panel) and all manual shut-off valves located upstream of the solenoid valves are in the open position.
2. Determine whether the solenoid valves are operating using the float switch performance guidelines provided above. If make-up water flow cannot be easily observed, verify whether the solenoid valves are operating by listening for a buzzing sound and/or checking the temperature of the solenoid valve coil.
3. If the solenoid valves do not appear to be operating, have the RWH system inspected by a licensed plumber and/or electrician.

iii. Top-up drainage pipe performance

1. Determine whether the problem lies with top-up drainage piping by visually inspecting the flow of water through the air gap while doing the float switch performance evaluation (provided above) and/or simulating a top-up process by manually pouring water into the top-up drainage pipe through the air gap.
2. During the top-up process, if water overflows from the air gap, this may indicate some or all of the following problems:
  - a. the top-up drainage piping is undersized and/or the flow rate of make-up water is too high;
  - b. There is a blockage or obstruction in the top-up drainage piping; or
  - c. If the system is operating under cold weather conditions, then water in the top-up drainage pipe may have frozen.
3. To address these issues, first attempt to decrease the flow rate of make-up water into the top-up drainage pipe, and observe the make-up process to see if this corrects the problem. If this problem arose during a period of extreme cold weather, it may be necessary to winterize or decommission the RWH system (refer to the instructions in *chapter 2. Rainwater storage and tank sizing for details*), then monitor the performance of the make-up system after the temperature rises.
4. If the above recommendations do not resolve the problem, the make-up system and top-up drainage piping may need to be examined and/or scoped by a licensed plumber to determine whether there are any obstructions.

**2. Backflow preventer testing and maintenance**

- a. Backflow preventers shall be tested and maintained in accordance with CAN/CSA-B64.10.1-07 Maintenance and Field Testing of Backflow Preventers.

**3. If the make-up system is operating properly, it is recommended that it still be inspected once every six months to:**

- a. verify that the float switch wires are not tangled with other float switches, the pump or other objects in the tank;
- b. remove any dirt and/or debris that have accumulated on the float switches, as necessary; and
- c. observe the make-up system while operating to ensure that water is not overflowing from the top-up drainage pipe at the air gap or discharging from the backflow preventers. If any water is leaking or discharging, refer to the troubleshooting instructions above.

**4. While inspecting, cleaning or repairing the make-up system, follow all necessary safety precautions, such as disconnecting the power supply, when necessary.**



# Chapter 5

Pump and pressurized  
distribution system

## 5.1 INTRODUCTION

To supply rainwater to permitted fixtures, a pump and pressurized distribution system is often required. Water is pumped from the rainwater tank, pressurized, and delivered to fixtures located at higher elevations in the building. The system is composed of a pump, a 'pressure tank' (a tank used to store pressurized water), a pressure switch or constant pressure components, independent plumbing lines and various other plumbing components.

To ensure the proper operation of these systems, care must be taken when selecting the type and size of the pump and associated pressure tank. The pressure system must be capable of supplying water at a sufficient rate and pressure to all the fixtures it is connected to, even those located the furthest away from the pump. In addition, it must be designed and installed to minimize the risk of a cross-connection and potential backflow (refer to *chapter 4. Make-up water system and backflow prevention* for further details). Homeowner maintenance is also critical, as homeowners must periodically inspect the system and be capable of troubleshooting the system, if an issue with the pump does arise.

## 5.2 APPLICABLE CODES, STANDARDS AND GUIDELINES

Table 5-1 references specific codes and standards that are applicable to pressure systems.

**Table 5-1** Applicable standards, codes and guidelines for pump and pressure distribution systems

Applicable codes, standards and guidelines	Selected provisions and design and installation implications
<p><b>National Plumbing Code of Canada (2010) and (2005)</b></p>	<ul style="list-style-type: none"> <li>■ <b>2.2.5.5. Polyethylene Pipe and Fittings</b></li> <li>■ <b>2.2.5.7. Crosslinked Polyethylene Pipe and Fittings</b></li> <li>■ <b>2.2.5.8. PVC Pipe and Fittings</b></li> <li>■ <b>2.2.5.9. CPVC, Pipe, Fittings and Solvent Cements</b></li> <li>■ <b>2.2.7.1. Copper and Brass Pipe</b></li> <li>■ <b>2.3.4.5. Support for Horizontal Piping</b></li> <li>■ <b>2.6.3. Size and Capacity of Pipes</b></li> <li>■ <b>2.7.1.1. Not Permitted</b></li> <li>■ <b>2.7.2.1. Markings Required</b></li> <li>■ <b>2.7.3.2. Outlets</b></li> <li>■ <b><u>2.7.4.1.(2) Non-potable Water Systems</u> – [NEW IN 2010 NPC]</b></li> </ul> <p>Articles 2.2.5.5., 2.2.5.7., 2.2.5.8., 2.2.5.9. and 2.2.7.1. specify approved pipe materials for pressure applications. Article 2.3.4.5. provides specifications for the support of piping.</p> <p>Subsection 2.6.3. provides a method for sizing water distribution systems, as per tables 2.6.3.2.A., 2.6.3.2.B., 2.6.3.2.C., 2.6.3.2.D. and table A-2.3.6.1.(2)A.</p> <p>Articles 2.7.1.1. and 2.7.2.1. specify that rainwater pressure pipes shall not be connected to potable water pipes and that rainwater shall not discharge into a sink, or where a potable outlet discharges or food/drink is prepared. Rainwater pressure piping shall have markings that are permanent and easily recognized, as per 2.7.2.1.</p> <p>Sentence 2.7.4.1.(2) specifies that rainwater may be used to supply water closets, urinals and directly connected underground irrigation systems that dispense water only below the surface of the ground.</p>

Applicable codes, standards and guidelines	Selected provisions and design and installation implications
<p><b>National Plumbing Code of Canada (2005)</b></p>	<ul style="list-style-type: none"> <li>■ <b>2.2.5.5. Polyethylene Pipe and Fittings</b></li> <li>■ <b>2.2.5.7. Crosslinked Polyethylene Pipe and Fittings</b></li> <li>■ <b>2.2.5.8. PVC Pipe and Fittings</b></li> <li>■ <b>2.2.5.9. CPVC, Pipe, Fittings and Solvent Cements</b></li> <li>■ <b>2.2.7.1. Copper and Brass Pipe</b></li> <li>■ <b>2.3.4.5. Support for Horizontal Piping</b></li> <li>■ <b>2.6.3. Size and Capacity of Pipes</b></li> <li>■ <b>2.7.1.1. Not Permitted</b></li> <li>■ <b>2.7.2.1. Markings Required</b></li> <li>■ <b>2.7.3.2. Outlets</b></li> </ul> <p>Articles 2.2.5.5., 2.2.5.7., 2.2.5.8., 2.2.5.9. and 2.2.7.1. specify approved pipe materials for pressure applications. Article 2.3.4.5. provides specifications for the support of piping.</p> <p>Subsection 2.6.3. provides a method for sizing water distribution systems, as per tables 2.6.3.1. and 2.6.3.2. and table A-2.6.1.1.(1).</p> <p>Articles 2.7.1.1. and 2.7.2.1. specify that rainwater pressure pipes shall not be connected to potable water pipes and that rainwater shall not discharge into a sink, or where a potable outlet discharges or food/drink is prepared. Rainwater pressure piping shall have markings that are permanent and easily recognized, as per 2.7.2.1.</p>
<p><b>Canadian Electrical Code (Current ed.)</b></p>	<ul style="list-style-type: none"> <li>■ <b>All electrical equipment must be approved and installed according to the requirements of the current edition of the <i>Canadian Electrical Code</i></b></li> </ul>
<p><b>CSA Standard B128.1 (2006)</b></p>	<ul style="list-style-type: none"> <li>■ <b>5 Installation Requirements</b></li> <li>■ <b>9 Pumps</b></li> <li>■ <b>10 Separation</b></li> <li>■ <b>11 Testing</b></li> <li>■ <b>12 Markings</b></li> </ul> <p>Provides guidelines for the pipes, pumps and plumbing accessories used for RWH systems, separation of rainwater pipes and potable water pipes, and testing for cross-connections, as well as the markings for rainwater service pipes and outlets.</p>



Mandatory documents



Supplementary documents

### 5.3 ISSUES FOR CONSIDERATION

#### General

The pump and pressurized distribution system is composed of a series of interconnected components, located both inside the rainwater tank and inside the building. A typical pressure system for a rainwater tank in a below-ground application is shown in figure 5-1.

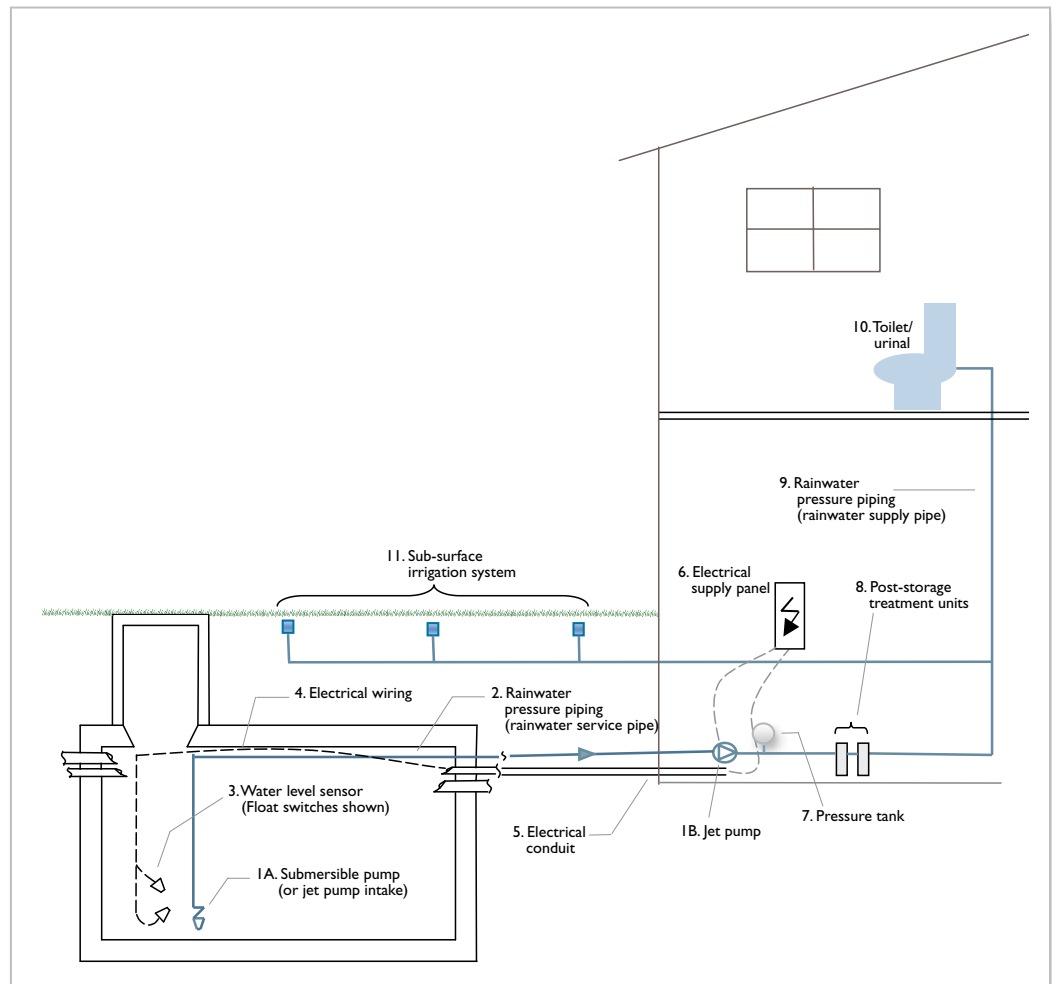

**Figure 5-1** Typical pump and pressurized distribution system for below-ground rainwater tank

As shown in figure 5-1, rainwater is drawn from the storage tank by a submersible pump located directly inside the tank [IA] or a “jet” pump located inside the building [IB]. This rainwater is pumped through a rainwater pressure piping [2], which runs from the tank to a suitable location (such as a mechanical room or basement utility room) in the building. To protect the pump from dry running, water level sensors [3], such as float switches, are often used. The electrical wiring from the water level sensor(s) and pump (if applicable) are then run through a protective electrical supply conduit [5] to an electrical supply panel [6].



Inside the building, the rainwater pressure piping is connected to a pressure tank and/or pump control unit [7] (depending upon the style of pump). If the RWH system will incorporate post-storage treatment units [8], these must be installed after the jet pump and any pressure tank and/or control unit. Following treatment (if performed), a rainwater pressure piping [9] are run to the permitted fixtures [10-11].

## Pump

---

To select the appropriate pump for a given RWH system, four criteria must be considered:

- pump location, controller configuration and voltage;
- pump flow rate;
- pump system pressure, or “head;” and
- acceptability of service interruptions.

### ***Pump location, controller configuration and voltage***

As shown in figure 5-1, either a submersible pump located inside the tank or a jet pump located outside the tank in an indoor/enclosed location may be used. Other types of exterior pumps are available as an alternative to jet pumps, such as vertical multi-stage pumps. However, these are generally more suited to multi-residential and commercial applications and, as such, shall not be discussed further:

With regard to submersible and jet pumps, each has its advantages and disadvantages, which are discussed in table 5-2.

**Table 5-2** Advantages and disadvantages associated with submersible and jet pumps

Style of pump	Advantages	Disadvantages
<b>Submersible pump</b>	<ul style="list-style-type: none"> <li>■ More efficient, has a longer lifespan than jet pump</li> <li>■ Reduces the amount of equipment and space needed outside the rainwater tank</li> <li>■ Low noise</li> </ul>	<ul style="list-style-type: none"> <li>■ Pump must be physically extracted from tank to perform inspection, repair and/or replacement</li> <li>■ May be more difficult to detect pump dry running (or any malfunction) as operation of pump may not be audible</li> <li>■ Pumps generally designed for vertical installation, but must be installed horizontally, as vertical installation reduces usable cistern capacity (increases dead space volume)</li> </ul>
<b>Jet pump</b>	<ul style="list-style-type: none"> <li>■ Pump can be easily inspected, repaired and/or replaced</li> <li>■ Generally less expensive than submersible pumps</li> </ul>	<ul style="list-style-type: none"> <li>■ More difficult to commission than submersible pumps, as they must be 'primed'</li> <li>■ Pump must be located in a temperature-controlled space (indoors, pump house, etc.)</li> <li>■ Pump operation may be noisy</li> </ul>

Once a pump has been selected, the configuration of the pump controller must be determined. In general, there are two options available: constant speed pumps and variable speed drive (VSD) pumps, otherwise known as variable frequency drive (VFD) pumps.

1. **Constant speed pumps** – Following a large drop in system pressure, a constant speed pump will activate and pump water at a fixed rate to replenish the volume of water stored in the pressure tank.
2. **VSD/VFD Pumps** – Unlike constant speed pumps, VSD/VFD pumps can increase or decrease the speed of the pump impeller to provide more or less water as needed by the pressure system.

The advantages and disadvantages of each type of pump are summarized in table 5-3.

**Table 5-3** Advantages and disadvantages associated with type of pump

Pump controller configuration	Advantages	Disadvantages
<b>Constant speed pump</b>	<ul style="list-style-type: none"> <li>■ Generally less expensive than VSD/VFD pumps</li> <li>■ Ideal for applications where minor variations in water pressure and flow rate are acceptable (for example, refilling toilet tanks after flushing and operating a garden hose)</li> </ul>	<ul style="list-style-type: none"> <li>■ Pressure tanks can be quite large for applications requiring high flow rates</li> <li>■ Flow rate and system pressure may spike when pump activates, and pressure may drop if water demand is too high</li> </ul>
<b>Variable speed drive/variable frequency drive pump</b>	<ul style="list-style-type: none"> <li>■ Provides constant pressure to fixtures, regardless of demand</li> <li>■ Uses very small pressure tanks, or micro-pressure tank inside the pump or control unit</li> <li>■ Often has built in low/high voltage shut-off and dry run protection</li> <li>■ Smaller space requirements in the building</li> <li>■ Lower electricity consumption than comparable constant speed pumps.</li> </ul>	<ul style="list-style-type: none"> <li>■ Use of smaller pressure tanks requires a greater number of ‘pump starts’ potentially increasing pump wear</li> <li>■ More expensive than constant speed pump systems</li> </ul>

The final decision regarding the type of pump is its operating voltage, either 120V or 240V. Pump manufacturers generally recommend using a 240V supply for pumps as this tends to reduce the need for heavy gauge wiring and switching components. Before selecting either voltage, however, it is recommended that the homeowner contact an electrician and the pump supplier to inquire regarding the appropriate pump and wire voltage. It is also important to note that any components wired in with the pump, such as water level sensors, will have to operate at the same voltage as the pump. Refer to *chapter 4. Make-up water system and backflow prevention* for further details.

**Pump flow rate**

The amount of flow that must be generated by the pump depends on the type and number of fixtures connected to the distribution system. One method of determining this flow rate is to sum up the required flow rates of all the fixtures, assuming a ‘worst case’ scenario where all fixtures are operating at one time. This approach is not recommended,

however, as it tends to over-size the pump, increasing the cost of the pump and pressure system. Instead, it is recommended that the pump flow rate be sized to handle a portion of this maximum flow, referred to as the 'maximum peak flow.'

### Pump head

Once the flow rate has been determined, the next task is to calculate the amount of pressure, or "head," the pump must provide. Two factors must be considered:

1. **required system pressure** – This is the pressure required by the fixtures connected to the pump and pressurized distribution system; and
2. **total dynamic head (TDH)** – This is the loss in pressure (or "head loss") that occurs when water is lifted from a low elevation to a high elevation, and the loss that occurs when water is being pumped through a long stretch of pipes and fittings.

Total dynamic head is composed of three components:

1. **static lift** is the height that water must be lifted before arriving at the pump (applicable only to systems utilizing a jet pump);
2. **static height** is the height from the pump to the furthest fixture; and
3. **friction loss** is the pressure loss when water travels through pipes and fittings.

Figure 5-2 illustrates the components of pump head

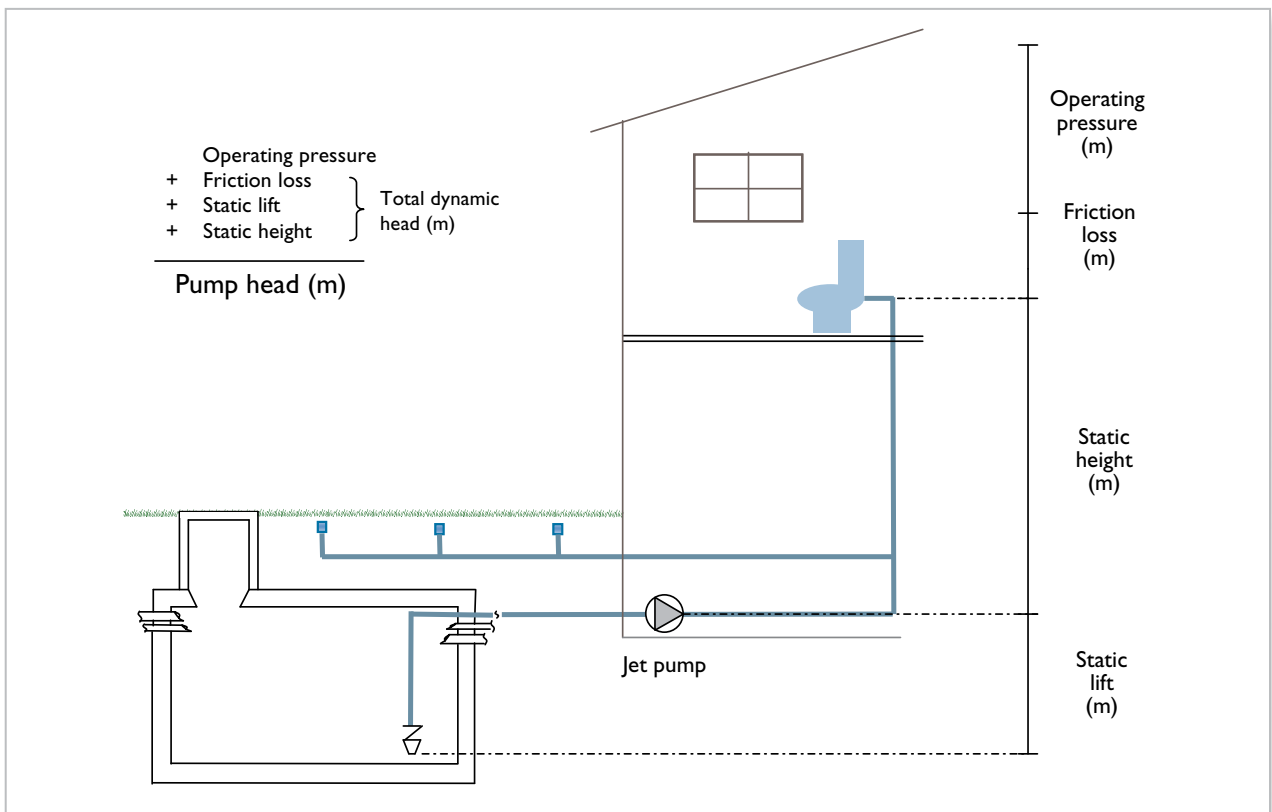

**Figure 5-2** Components of total dynamic head (TDH)

Once both the pump head and the flow rate are determined, a pump can be selected, using pump curves provided by manufacturers.

### ***Acceptability of service interruptions***

A final issue to be considered is whether it is acceptable for non-potable water service to be interrupted by pump downtime or other potential problems associated with the RWH system. In a typical residential setting, where rainwater is used for toilet flushing and outdoor use, infrequent service interruptions are likely to be generally acceptable, and no added measures are necessary.

For residential settings where rainwater is used to supply much or all of the household needs, or in multi-residential or commercial settings where water is needed for toilet and urinal flushing, service interruptions may not be acceptable. For such settings, two options are available: a dual-pump arrangement, often referred to as a duplex pump arrangement, or an automatic bypass system.

A drawback of duplex pump arrangements is that they tend to be much more expensive than single-pump systems; however, many offer control equipment to periodically cycle between pumps, which improves the lifespan of both pumps. Another advantage of these pumps is that they can be purchased pre-assembled and installed in much the same way as a typical single-pump arrangement.

## **Pipes**

---

There are two distinct sections of rainwater pressure piping:

- 1. rainwater service pipe** – the section of pipe from the storage tank to a jet pump, or from the storage tank to the pressure tank/control unit for submersible pumps; and
- 2. rainwater supply pipe** – the section of pipe from the jet pump, or pressure tank/control unit for submersible pumps, to the permitted fixtures.

Each section has unique criteria that must be considered during design and installation, resulting in different pipe material, sizing and installation requirements. For instance, below-ground rainwater tanks require a rainwater service pipe that is suitable for burial and, as this pipe will always have water in it, it is critical that it be well protected from freezing. Rainwater supply piping is inside the building and must be installed in accordance with codes to ensure that a cross-connection is not made. Both sections of pipe must be sized to handle the flow generated by the pump and to ensure that each fixture receives rainwater at a sufficient rate, with service piping typically requiring larger pipe diameters than supply piping.

To prevent cross-connections, rainwater piping must be marked to indicate that the pipes contain non-potable water. Pipe markings must be distinctive and easily recognizable—typically purple is used to identify the piping as containing non-potable water. An example of pipe marking is shown in figure 5-3.

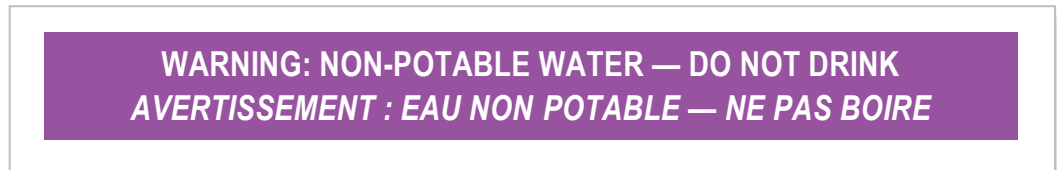

**Figure 5-3** Typical marking for rainwater pressure piping

Another means of identifying rainwater pressure piping is to use a distinctive pipe colour—purple—to prevent future plumbing cross-connections.

## Pressure tank

Pressure tanks perform two functions in a pump and pressurized distribution system:

1. store pressurized water to minimize pump on/off cycling frequency; and
2. maintain a constant pressure in the distribution system.

To accomplish these tasks, pressure tanks are composed of an exterior shell with an inner bladder that is equipped with a pressure sensor connected to the pump. The pump starts when the pressure in the bladder drops to the cut-in point and shuts off when the pressure in the bladder reaches the cut-out point.

Other than the pressure sensor, the most important factor in ensuring proper operation of the pressure system is sizing the pressure tank so that it is compatible with the type of pump and the pump's flow rate.

Constant speed pumps require larger pressure tanks than VSD/VFD pumps because they are designed to store the volume of water discharged by the pump over a 1-2 minute period. This is the minimum time the pump is permitted to operate once activated and is referred to as "pump run time." A longer pump run time requires a larger pressure tank, but minimizes wear due to frequent pump starts. For VSD/VFD pumps, the size and style of pressure tank tends to vary by manufacturer. Some manufacturers specify the use of small (~1 gallon) tanks that are installed like larger pressure tanks, whereas others incorporate micro-pressure tanks inside the pump or in a control panel.

## 5.4 DESIGN AND INSTALLATION GUIDELINES

### 1. Determine the fixtures connected to rainwater.

- a. In Canada, the *2010 National Plumbing Code* permits rainwater to be used for:
  - i. toilet and urinal flushing; and
  - ii. directly connected underground irrigation systems that dispense water only below the surface of the ground.
- b. Consult the applicable provincial/territorial codes and regulations for permitted fixtures.

### 2. Select the pump.

- a. Determine the style and operating characteristics.
  - i. Style: jet pump or submersible pump.
  - ii. Controller configuration: constant speed or VSD.
  - iii. Operating voltage: 120 V or 240 V.
- b. Determine the required flow rate.
  - i. Consult applicable codes and regulations, industry standards, local authorities and the irrigation system manufacturer (if applicable) for minimum pump flow rate.
  - ii. For guidance purposes only, a method for estimating minimum pump flow rate, based on the maximum peak demand sizing method, is provided in *Appendix C*.
- c. Determine the pump head.
  - i. Consult applicable codes and regulations regarding minimum pump flow pressure and maximum static pressure.
  - ii. A method for determining the pump head is provided in *Appendix C*.
- d. Consult the pump manufacturer or supplier, or use the pump manufacturer's 'pump curve' charts, to select the appropriate pump model, given style, operating characteristics, required flow rate and pump head.
- e. If pump downtime is not permitted or desired:
  - i. provide a generator or battery backup for the pump; and/or
  - ii. provide a backup pump or duplex pump arrangement.

### 3. Select the pressure tank.

- a. Consult the pump manufacturer or supplier regarding the minimum pressure tank size for the pump, based on pump controller configuration and pump flow rate.
- b. For guidance purposes only, a method for sizing the pressure tank for constant speed pumps is provided in *Appendix C*.

### 4. Plan the layout of the pump and pressurized distribution system.

- a. Plan route of the rainwater service piping from the jet pump, pressure tank or control unit to the tank (refer to *section 1.4 Design and installation guidelines* for guidelines and applicable provincial/territorial codes and regulations regarding installation of underground piping).
- b. Plan route of the rainwater supply piping from the jet pump, pressure tank or control unit to the permitted fixtures.
- c. Plan route of electrical conduits from the location of the power supply to the tank (route with float switch wiring where possible, refer to *chapter 4. Make-up water system and backflow prevention* for further details).

- d. Contact the municipality and service providers to ensure that there are no buried service lines (gas, electricity, water, stormwater, wastewater, phone or cable lines) in the area where digging will take place to bury rainwater service piping and/or electrical conduits.

## 5. Rainwater pressure piping

- a. Rainwater pressure piping is composed of two distinct sections of pipe.
  - i. Rainwater service pipe:
    - 1. piping from the storage tank to a jet pump; or
    - 2. piping from the storage tank to the pressure tank/control unit for submersible pumps.
  - ii. Rainwater supply pipe:
    - 1. piping from the jet pump (or pressure tank/control unit for submersible pumps) to the permitted fixtures.
- b. Rainwater service pipes
  - i. Pipe material
    - 1. Polyethylene pipe is recommended.
    - 2. Pipe selected must be approved by applicable provincial/territorial codes and industry standards (CSA, ASTM, etc.).
  - ii. Pipe size
    - 1. Pipe shall be sized to handle the maximum flow rate of the pump in accordance with the pump manufacturer's instructions.
    - 2. For estimation purposes, service pipe size can be calculated using the method provided in *Appendix C*.
  - iii. Tank connection
    - 1. Rainwater service piping should enter the tank at a height no lower than the overflow drainage piping, or, ideally, 50 mm [2 in.] above the top of the overflow drainage pipes entering the tank.
    - 2. Where entering the tank at a height no lower than the overflow drainage piping exposes the rainwater service piping to frost, rainwater service piping may enter the tank at a lower height, provided the tank connection is watertight.
- c. Rainwater supply pipes
  - i. Pipe material
    - 1. Cross-linked polyethylene (PEX) is recommended.
    - 2. Pipe selected must be approved by applicable provincial/territorial codes and industry standards (CSA, ASTM, etc.).
  - ii. Pipe size
    - 1. Consult the applicable provincial/territorial codes and regulations pertaining to water supply pipe sizing.
    - 2. For estimation purposes, supply pipe size can be calculated using the method provided in *Appendix C*.

## 6. Installation of rainwater pressure piping

- a. Connection
  - i. Rainwater pressure piping shall not be connected to a potable water system.
  - ii. Rainwater pressure piping shall only be connected to fixtures permitted by applicable provincial/territorial codes and regulations.



b. Support and protection

- i. Underground piping shall be located in a properly excavated space, supported and properly backfilled in accordance with applicable provincial/territorial codes and regulations.
- ii. Piping inside a building shall be supported in accordance with applicable provincial/territorial codes and regulations.
- iii. Piping shall be protected from frost (refer to *section 1.4 Design and installation guidelines* for details).

c. Operation and maintenance considerations

- i. Rainwater service piping connected to a jet pump must be installed on a horizontal or a consistent upward slope from the storage tank to the pump.
  - ii. To minimize the possibility of leaks, underground rainwater service piping should be installed with no, or few, pipe fittings.
  - iii. To facilitate repair and/or replacement of underground rainwater service piping, piping should be installed inside a rainwater service conduit, where the conduit material can be flexible drainage tubing (typically referred to as “Big O” tubing) or any other suitable material.
- d. Underground non-metallic pipes should be installed with ‘tracer tape’ (also referred to as ‘tracer wire’) at a height of 300 mm [12 in.] above the pipe for the purpose of locating as-installed piping.

7. Pipe markings<sup>19</sup>

- a. All rainwater pressure pipes shall be clearly identified and marked in accordance with applicable provincial/territorial codes and regulations.
- b. Pipes shall be marked as follows:
  - i. Text/legend
    - 1. WARNING: NON-POTABLE WATER — DO NOT DRINK  
AVERTISSEMENT : EAU NON POTABLE — NE PAS BOIRE
    - 2. Text must be legible with letters no less than 5 mm in height, except where pressure pipe size makes 5 mm high letters impractical.
  - ii. Colour
    - 1. marking labels shall be purple in colour; or
    - 2. pipes shall be purple in colour; or marked with a continuous purple stripe.
  - iii. figure 5-4 provides an example of typical pipe marking:

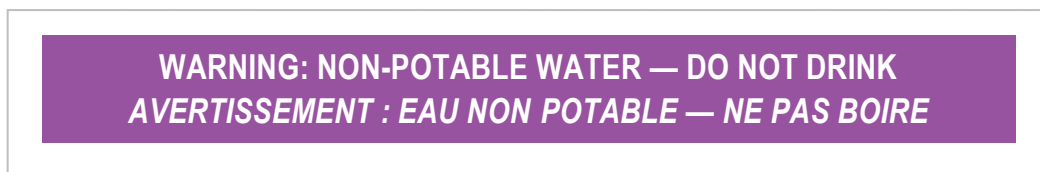

**Figure 5-4** Typical marking for rainwater pressure piping

c. Spacing of markings

- i. Markings shall be repeated at intervals of not more than 1.5 m.

<sup>19</sup> Adapted from CAN/CSA-B128.1-06 Design and installation of non-potable water systems. 2006. CSA International, Mississauga, ON. Refer to CAN/CSA-B128.1-06 for further details.

**8. Installation of pump**

- a. Pumps shall be installed in accordance with the manufacturer's instructions.
- b. Pumps shall be installed so that they are readily accessible (submersible pumps must be retrievable without entry into the tank).
- c. Pumps shall be provided with dry run protection. Consult pump specifications to determine whether pump has built-in dry run protection. If not, provide a water level sensor (refer to *chapter 4. Make-up water system and backflow prevention* for details).
- d. For jet pumps
  - i. The rainwater service pipe should terminate no less than 100-150 mm [4-6 in.] above the bottom of the tank.
  - ii. Pump prime shall be maintained by a foot valve located at the rainwater service pipe intake, or a check valve located in the rainwater service pipe upstream of the jet pump.
- e. For submersible pumps
  - i. The pump intake should be located no less than 100-150 mm [4-6 in.] above the bottom of the tank.
  - ii. Pump prime shall be maintained by a check valve located in the rainwater service pipe downstream of the jet pump (consult pump manufacturer's instructions to determine if required).
- f. Electrical requirements
  - i. All wiring must be installed in accordance with the current edition of the *Canadian Electrical Code*. Refer to the pump manufacturer's installation instructions for further details.
  - ii. Electrical wiring installed outdoors and/or underground should be provided with protection.
  - iii. The pump should be installed on a dedicated circuit, with a motor disconnect switch installed near the pressure tank or control panel (refer to the *Canadian Electrical Code* for specifics).
  - iv. For buried tanks, electrical wiring should be suitable for burial and/or run through a protective conduit made of PVC pipe, or "Big-O"-style drainage pipe.
  - v. Buried electrical wiring and/or conduits should be installed in a properly prepared and backfilled space (refer to *chapter 1. Rainwater catchment and conveyance* for details).

**9. Installation of pressure tank**

- a. Pressure tanks shall be installed in accordance with the manufacturer's instructions.
- b. Pressure tanks shall be installed so that they are readily accessible.
- c. Pressure tanks shall be installed with a means for observing the system pressure, such as a pressure gauge.
- d. Pressure sensor or pressure switch installed with the pressure tank must be wired in with the pump (and a control panel if applicable).
- e. All wiring must be installed in accordance with the current edition of the *Canadian Electrical Code*.

**10. Install post-storage treatment devices as required (refer to *chapter 3. Rainwater quality and treatment* for details).****11. Commission the pump and pressurized distribution system in accordance with the manufacturer's instructions. Instructions for a typical constant speed pump are provided in *section 5.5*.**

## 5.5 MANAGEMENT GUIDELINES

1. **If the pump and pressurized distribution system stops operating, or if there are problems during the commissioning process, follow the troubleshooting steps outlined below.**
  - a. Ensure that the proper pump and pressure equipment were selected and installed in accordance with the provided Design and installation guidelines.
  - b. Visually examine the volume of rainwater in the storage tank.
    - i. If the rainwater tank is empty, the pump and pressurized distribution system should not operate, and the fact that it is "off" may indicate that a water level sensor connected to the pump or the pump's internal dry run protection is acting as intended and preventing the system from operating.
    - ii. If there is sufficient rainwater in the tank and the pump and pressurized distribution system is not operating, examine the electrical supply for the pump and pressurized distribution system. Verify that all necessary components are connected to the electricity supply, and that all components are supplied electricity (that is, all on/off switches are in the 'on' position and any electrical panel breakers are also in the 'on' position).
    - iii. *Note: In the event of a power failure, rainwater cannot be supplied to connected fixtures unless back-up provisions, such as an automatic bypass back-up system, were included in the design of the RWH system.*
2. **Most often a problem with the pump and pressurized distribution system is not due to the pump itself but the associated components and equipment. The following steps are recommended for examining each of these components.**
  - a. A licensed plumber, electrician or other skilled technician should be consulted regarding the troubleshooting and/or repair of the pump and pressurized distribution system. The following steps are provided only as a guide.
  - b. Make-up water system and water level sensors
    - i. During the visual inspection of the rainwater storage tank, if the tank appeared empty, but the RWH system includes a top-up system, this may indicate that there are problems with the back-up system. Refer to *chapter 4. Make-up water system and backflow prevention* for instructions on how to troubleshoot this system.
    - ii. If the RWH system utilizes an automatic bypass make-up system, an empty tank may be normal, given insufficient rainfall or heavy use. This system should automatically provide potable water to fixtures (bypassing the RWH system). If this system does not operate, or if pump operation does not resume following the addition of rainwater to the tank, this may indicate that there are problems with the back-up system.
    - iii. If a manual top-up or bypass back-up system is utilized, direct intervention is required to activate these systems. These systems must be activated prior to the storage tank running empty; otherwise, a water level sensor connected to the pump, or the pump's internal dry run protection, will prevent the pump and pressurized distribution system from operating.
    - iv. If the top-up system appears to be functioning as intended, the problem with the pump and pressurized distribution system may lie with the water level sensor connected to the pump. Instructions on how to inspect, test and adjust a float switch water level sensor is provided in *chapter 4. Make-up water system and backflow prevention*.
  - c. Pressure tank
    - i. If the pump cycles on and off repeatedly and/or the system never comes up to the desired pressure, there may be a problem with the pressure tank.
    - ii. The static pressure of the pressure tank (the pressure of the tank when there is no water inside) must be 14 kPa [2 psi] less than the desired cut-in pressure.

- d. Pressure sensor/switch
    - i. Pump cycling and/or an inability to come up to the desired pressure may also indicate a problem with the pressure sensor/switch.
    - ii. For VSD/VFD pumps using a pressure sensor, the pressure settings will likely need to be set using a control panel (refer to the pump and pressure tank manufacturer's installation instructions for details).
    - iii. For constant speed pumps using a pressure switch, consult the pump and/or pressure switch manufacturer's instructions on adjusting the pressure switch.
  - e. Pipes and shut-off valves
    - i. If a jet pump appears to be dry running, or if a submersible pump appears to run for a period of time but does not discharge any water, there may be a blockage in the rainwater pressure piping.
    - ii. If the tank is located outdoors and below ground, there is a chance that, under extreme cold conditions, rainwater may have frozen in the pipes, preventing flow in the rainwater pressure piping. It may be necessary to wait for the temperature to rise to determine whether this is the source of the problem.
    - iii. A blockage can also be created if a shut-off valve located in the rainwater pressure piping is in the 'closed' position. Inspect all shut-off valves to ensure they are open.
  - f. Foot valves, check valves and leaks in the system
    - i. If the pump cycles on during times when there is no rainwater demand or if the pressure gauge shows that the system pressure is slowly decreasing over time, there may be a problem with the foot valve or check valve or there may be a leak in the system.
    - ii. Inspect all foot valves and check valves to ensure that they are installed in the correct orientation (as indicated on the device) and that the valve is not clogged by dirt and debris.
    - iii. If the foot valves and check valves appear to be operating properly, then there may be a leak in the rainwater pressure piping. Inspect all piping to ensure that there are no leaks from the pipelines or from the fixtures connected to the pump and pressurized distribution system.
3. **If the above steps do not resolve the issues with the pump and pressurized distribution system, the problem may lie directly with the pump. Refer to the pump manufacturer's operating instructions for troubleshooting recommendations, and if these actions are unsuccessful at resolving the problem, consult a licensed plumber, electrician and/or pump service technician.**
  4. **If the pump and pressurized distribution system is operating properly, it is recommended that it still be inspected once annually to:**
    - a. ensure that the pump and pressurized distribution system is in good working order; and that there is no obvious sign of pump overheating or pump wear;
    - b. ensure that there are no leaks in the rainwater pressure piping; and
    - c. observe the pressure system when no demands are placed on it. If the pump cycles repeatedly during a period when no demands are present, this may indicate that there are problems with the foot valve or check valve, or that there is a leak in the rainwater pressure piping.
  5. **While inspecting and/or repairing the components of the pump and pressurized distribution system, follow all necessary safety precautions, including disconnecting the electricity supply to the pump.**



The background of the top section of the page is a close-up photograph of water ripples, showing concentric circles and fine lines on a light blue surface. The ripples are more pronounced in the center and fade towards the edges.

# Chapter 6

## Overflow provisions and stormwater management

## 6.1 INTRODUCTION

On occasion, the volume of rainwater collected from the roof catchment will exceed the storage capacity of the rainwater storage tank, causing the tank to overflow. If overflow-handling provisions are not in place, excess rainwater will back up rainwater conveyance and top-up drainage piping, until it reaches a point from which it can most easily discharge/overflow. This may be at the downspout-to-conveyance drainage pipe transition, or at less ideal locations like the access opening of the tank, or at the air gap of a top-up system. Overflows at these points may damage the rainwater tank itself, or do water damage to a building's exterior or interior.

Due to the consequences of not properly handling excessive volumes of rainwater, it is important that the RWH system include sufficient overflow provisions. The design of overflow systems involves deciding where excess volumes of rain can be appropriately discharged, and how to convey these overflow volumes from the storage tank to the point of discharge. Addressing these issues generally falls under stormwater management.

Stormwater management has evolved considerably over the past decades, and has shifted from simply conveying stormwater off-site to managing it through on-site practices and treatment facilities designed to mitigate the environmental impacts of runoff. RWH systems are a new addition to stormwater management practices in Canada, and as such there is little guidance on how to integrate these systems into stormwater management programs. Despite lack of specific guidelines, many aspects of stormwater management are applicable to rainwater tank overflow handling.

This chapter will discuss stormwater management and regulatory requirements, and provide guidance on how to select, install and manage the most appropriate type of overflow-handling system, given these considerations and other issues, such as site conditions and tank location/placement. Since there are very few federal regulations or guidelines on the design and installation of stormwater management systems, this chapter uses the Province of Ontario *Stormwater Management Planning and Design Manual* for general design criteria and method.<sup>20</sup>

---

<sup>20</sup> Stormwater Management Planning and Design Manual. 2003. Ontario Ministry of the Environment, Toronto, ON.

## 6.2 APPLICABLE CODES, STANDARDS AND GUIDELINES

Table 6-1 references specific codes and standards that are applicable to overflow-handling systems.

**Table 6-1** Applicable standards, codes and guidelines for rainwater overflow handling systems

Applicable codes, standards and guidelines	Selected provisions and design and installation implications
<b>National Plumbing Code of Canada (2010) and (2005)</b>	<ul style="list-style-type: none"> <li>■ <b>2.4.2.2. Connection of Overflows from Rainwater Tanks</b></li> </ul> <p>Specifies that an overflow from a rainwater tank shall not be directly connected to a drainage system (an indirect connection is required).</p> <p><i>Note: Overflow drainage pipes must be sized and installed in accordance with the NPC provisions applicable to drainage piping. See chapter 1 for details.</i></p>
<b>CSA Standard B128.1 (2006)</b>	<ul style="list-style-type: none"> <li>■ <b>7.7 Overflow(s) capacity</b></li> <li>■ <b>7.8 Overflow discharge</b></li> </ul> <p>Specifies that the capacity of the overflow drainage pipes must be equal to the capacity of the conveyance drainage pipes, and that overflows must be discharged in accordance with local regulations.</p>
<b>Applicable Provincial/Territorial Stormwater Management Guidelines</b>  <b>For example: Ontario Stormwater Management Planning and Design Manual (2003)</b>	<ul style="list-style-type: none"> <li>■ <b>4.5.6 Roof Leader Discharge to Soakaway Pits</b></li> </ul> <p>Provides design and installation guidelines for lot-level infiltration systems.</p>

Mandatory documents

Supplementary documents



## 6.3 ISSUES FOR CONSIDERATION

### Overflow discharge locations

The purpose of the overflow system is to handle excessive rainwater flows, directing them away from the rainwater storage tank to a suitable location. Overflow volumes can be directed to grade, a storm sewer, or an onsite soakaway pit. In each case, rainwater can be conveyed via gravity flow or by pumping. Table 6-2 describes these options and includes sketches illustrating each overflow-handling method. In these illustrations, rainwater entering the tank during a rainfall event ( $Q_t$ ) has exceeded the storage capacity of the tank ( $S$ ).

Each overflow system has unique advantages and disadvantages, discussed in table 6-3 (listed from most to least recommended).

**Table 6-2** Overflow discharge locations and methods of conveying rainwater overflows

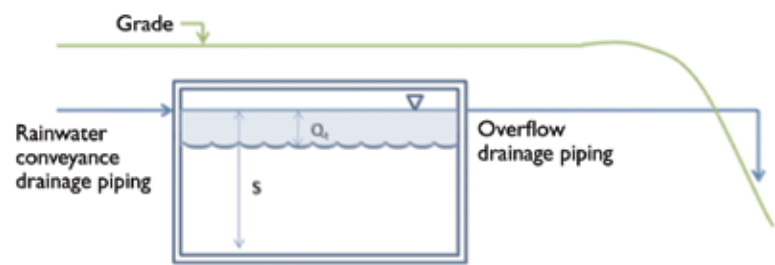
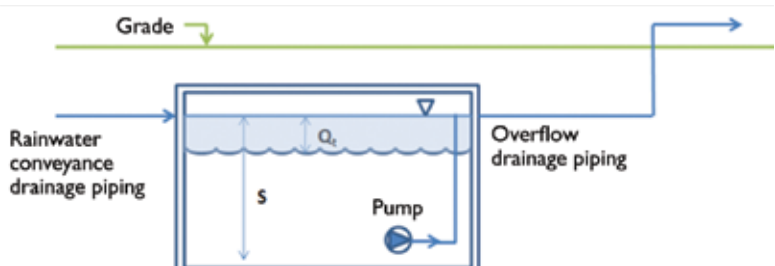
Overflow discharge locations/methods	Illustration/example
<p><b>1. Discharge to grade via gravity flow</b></p> <p>This method is applicable to tanks located above grade or below grade, where rainwater overflows can be directed to grade via gravity flow</p>	 <p>The diagram shows a rectangular rainwater storage tank. A horizontal line at the top represents the ground level, labeled 'Grade'. An arrow points down to this line. On the left, an arrow labeled 'Rainwater conveyance drainage piping' enters the tank. Inside the tank, a wavy line represents the water surface, with a vertical double-headed arrow labeled 's' indicating the water depth. Above the water surface, the label <math>Q_t</math> is shown. On the right side of the tank, an arrow labeled 'Overflow drainage piping' exits the tank. This pipe goes up and then curves over the 'Grade' line, discharging the water to the right of the tank.</p>
<p><b>2. Discharge to grade via pump-assisted flow</b></p> <p>This method is applicable to tanks located below ground or integrated into buildings, where rainwater overflows must be pumped to grade</p>	 <p>The diagram shows a rectangular rainwater storage tank. A horizontal line at the top represents the ground level, labeled 'Grade'. An arrow points down to this line. On the left, an arrow labeled 'Rainwater conveyance drainage piping' enters the tank. Inside the tank, a wavy line represents the water surface, with a vertical double-headed arrow labeled 's' indicating the water depth. Above the water surface, the label <math>Q_t</math> is shown. At the bottom of the tank, there is a circular component labeled 'Pump'. On the right side of the tank, an arrow labeled 'Overflow drainage piping' exits the tank. This pipe goes up and then turns horizontally to the right, discharging the water above the 'Grade' line.</p>

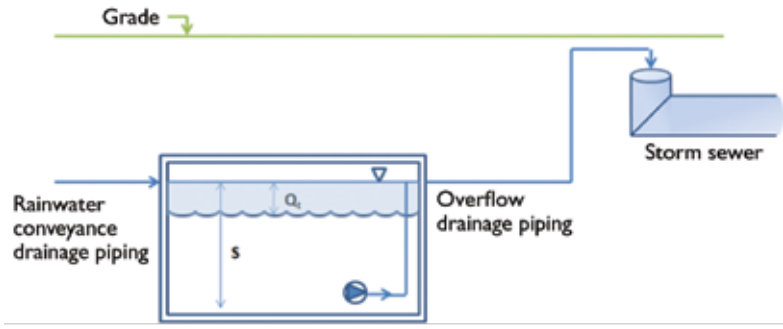
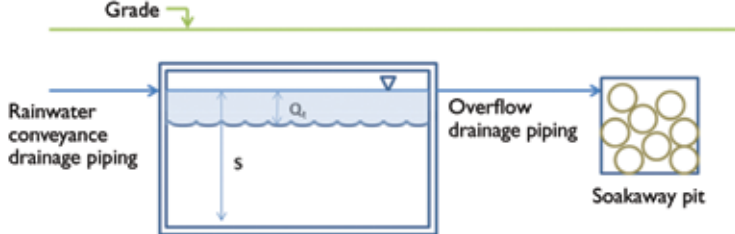
Overflow discharge locations/methods	Illustration/example
<p><b>3. Discharge to storm sewer via gravity flow</b></p> <p>This method is applicable to tanks located above grade or below grade, where rainwater overflows can be discharged into a storm sewer via gravity flow, although the tank cannot be directly connected to the sewer.<sup>1</sup></p>	 <p>The diagram shows a rectangular tank with a water level indicated by a dashed line. A horizontal line above the tank is labeled 'Grade'. An arrow labeled 'Rainwater conveyance drainage piping' points into the tank from the left. The water level is labeled <math>Q_t</math>. A vertical double-headed arrow labeled 's' indicates the depth of the tank. An arrow labeled 'Overflow drainage piping' points from the right side of the tank to a 'Storm sewer' located at a lower elevation than the tank's water level.</p>
<p><b>4. Discharge to storm sewer via pump-assisted flow</b></p> <p>This method is applicable to below-ground tanks and tanks integrated into buildings, where the storm sewer is located at a higher elevation than the storage tank.</p>	 <p>The diagram shows a rectangular tank with a water level indicated by a dashed line. A horizontal line above the tank is labeled 'Grade'. An arrow labeled 'Rainwater conveyance drainage piping' points into the tank from the left. The water level is labeled <math>Q_t</math>. A vertical double-headed arrow labeled 's' indicates the depth of the tank. An arrow labeled 'Overflow drainage piping' points from the right side of the tank to a 'Storm sewer' located at a higher elevation than the tank's water level. A small pump symbol is shown at the bottom of the tank, connected to the overflow piping.</p>
<p><b>5. Discharge to soakaway pit via gravity flow (pump-assisted flow N/A)</b></p> <p>This method is applicable to tanks located below ground, where rainwater overflows must be infiltrated on site and pumping to grade is impractical, and/or the overflow drainage piping cannot be connected to a storm sewer.</p>	 <p>The diagram shows a rectangular tank with a water level indicated by a dashed line. A horizontal line above the tank is labeled 'Grade'. An arrow labeled 'Rainwater conveyance drainage piping' points into the tank from the left. The water level is labeled <math>Q_t</math>. A vertical double-headed arrow labeled 's' indicates the depth of the tank. An arrow labeled 'Overflow drainage piping' points from the right side of the tank to a 'Soakaway pit' located at a lower elevation than the tank's water level. The soakaway pit is depicted as a square area containing several circles representing infiltration chambers.</p>

<sup>1</sup>Tanks can be indirectly connected to the storm sewer or, alternatively, a backwater valve can be installed on the overflow drainage piping in the case of a direct connection.

**Table 6-3** Comparison of the advantages and disadvantages associated with overflow discharge locations/methods

Overflow discharge locations/methods	Advantages	Disadvantages
<p><b>Discharge to grade via gravity flow</b> <b>(most recommended)</b></p>	<ul style="list-style-type: none"> <li>Simplest method to design, install and operate.</li> <li>Low probability of rainwater backing up the overflow drainage piping.</li> </ul>	<ul style="list-style-type: none"> <li>If discharge location not prepared properly, may cause soil erosion at site.</li> <li>May pose a nuisance/safety issue if discharging large volumes from big catchment surfaces.</li> <li>Overflow drainage piping may freeze if large sections are above the frost penetration depth; ice may build up at the point of discharge if not designed properly.</li> </ul>
<p><b>Discharge to storm sewer via gravity flow</b></p>	<ul style="list-style-type: none"> <li>Ideal for below-ground tanks as storm sewers are also located below grade.</li> <li>Storm sewers are specifically designed to collect roof runoff and direct it to an appropriate location off-site.</li> </ul>	<ul style="list-style-type: none"> <li>Design must prevent backflow from storm sewer into rainwater tank.</li> <li>Stormwater discharges can have negative environmental impacts on receiving water bodies.</li> </ul>
<p><b>Discharge to soakaway pit via gravity flow</b></p>	<ul style="list-style-type: none"> <li>Permits the handling of stormwater on site, which contributes to maintaining pre-development drainage regimes.</li> <li>Environmental benefits of groundwater recharge.</li> <li>In newer housing developments, an infiltration trench, serving multiple lots, may be built by the developer.</li> </ul>	<ul style="list-style-type: none"> <li>Soakaway pits require extensive site work to design and install (high in cost).</li> <li>Large rainfall events can exceed the infiltration capacity of the soil, requiring a separate overflow from the soakaway pit.</li> <li>Suitable only for permeable soils.</li> </ul>
<p><b>Discharge to grade or storm sewer via pump-assisted flow</b> <b>(least recommended)</b></p>	<ul style="list-style-type: none"> <li>In cases where the tank is located deep underground (building sub-basements, parking garages, etc.) this may be the only method of handling overflows.</li> </ul>	<ul style="list-style-type: none"> <li>Pump may fail in the event of a power outage.</li> <li>Large pump required to handle overflow volumes generated during intense rainfall events.</li> </ul>

## Selecting the most appropriate overflow discharge location

---

Selection of an overflow discharge location must not only include a comparison of the advantages and disadvantages discussed above, but also a number of other factors, which include:

- stormwater management requirements;
- applicable provincial/territorial regulations and municipal bylaws;
- location/placement of rainwater storage tank; and
- site conditions.

### ***Stormwater management requirements***

In some cases, overflow from the rainwater tank may need to be handled in accordance with special stormwater management requirements. These requirements may be imposed by a municipality or various conservation authorities for buildings located in an environmentally sensitive area, or in an area where the existing storm sewer infrastructure does not have sufficient capacity to accept additional stormwater flows, or for a variety of other reasons. Stipulations may include on-site retention of certain storm volumes with specified rates of release to the storm sewer and/or on-site management through infiltration or overland flow, for example. RWH systems and overflow provisions can be designed to meet such criteria.

Local authorities, including local conservation authorities, should be consulted during the RWH system design process, in order to verify whether special stormwater management practices are required.

### ***Applicable provincial/territorial regulations and municipal bylaws***

Even if there are no special stormwater management requirements, provincial regulations and municipal bylaws may still restrict the locations where rainwater overflows can be discharged. The *National Plumbing Code* prohibits the direct connection of an overflow from a rainwater tank to a storm sewer because of the possibility of storm sewage backing up into the rainwater tank during extreme rainfall events. Some municipalities may, however, accept such connections as long as they are protected by a backwater valve. Alternatively, an indirect connection may be made, where the rainwater tank overflows into either a small inceptor tank or soakaway pit, which in turn overflows into the storm sewer.

### ***Tank location***

The location of the storage tank can also have an impact on the overflow discharge location selected. Overflow handling is simplest with above-ground tanks, since overflows can typically be discharged to grade. Handling overflows is more challenging with

below-ground tanks and/or tanks integrated into buildings (located below grade). For these tanks, proximity to a storm sewer connection or to greenspace (for infiltration or overland flow) often plays a much greater role in determining where overflows can be directed.

### ***Site conditions***

Site conditions, such as topography, space availability and accessibility, and the existence of other buried services, also affect the selection of an overflow discharge location. For instance, a flat terrain may preclude the discharge of overflow from a buried tank to grade. Similarly, space constraints and buried service lines may limit excavation for overflow drainage piping and/or a soakaway pit.

Soakaway pits are particularly sensitive to site conditions. In addition to requiring significant space, they also require a degree of soil permeability (that is, soil cannot have a significant clay content). Sites with a large catchment area and/or low soil permeability may require a large infiltration area and/or the soakaway pit itself may require an overflow. In some cases, soakaway pits may not be feasible.

### **Soakaway pits**

---

Soakaway pits are composed of an excavated space filled with a non-porous material, such as stone, surrounded by an outer filter fabric. If the catchment area is very large and/or the soil is not sufficiently permeable, the soakaway pit may require its own overflow drainage pipe to a storm sewer or to grade. If treatment is required—for example, if the soil is very permeable and located near a well—a sand layer may be installed at the bottom of the trench. The basic version of an infiltration trench, considered to be suitable for most RWH systems, is illustrated in figure 6-1.

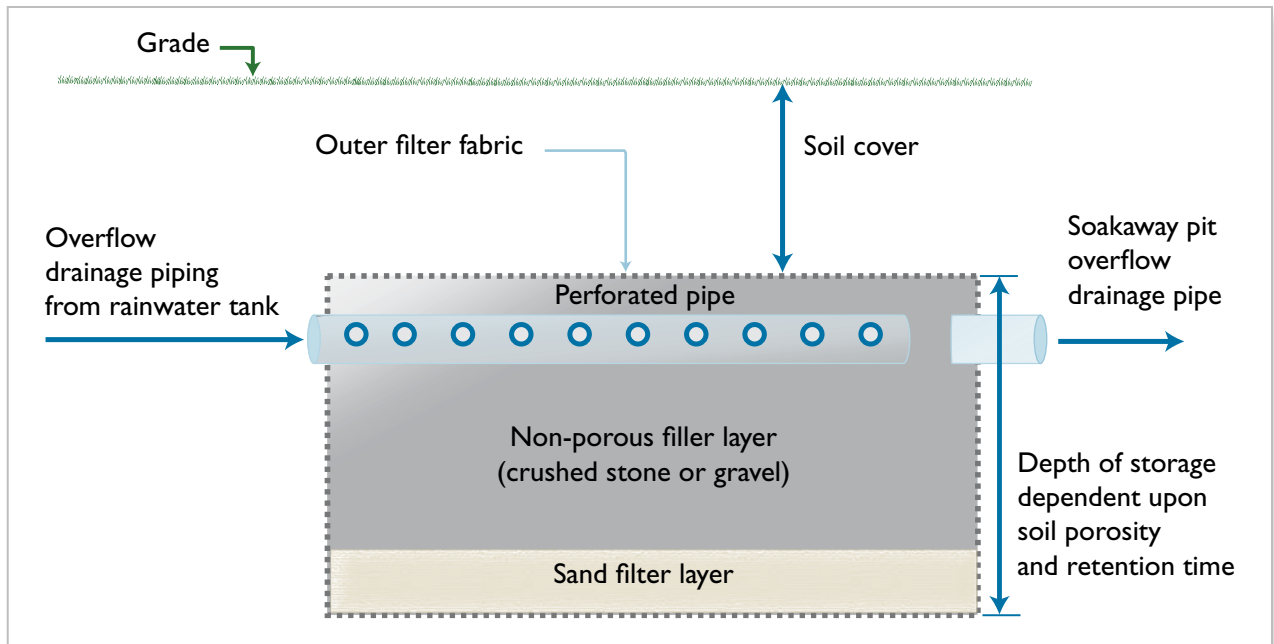

**Figure 6-1** A typical soakaway pit (cross-section view)<sup>21</sup>

The materials typically required for a soakaway pit include:

- **storage media** – crushed stone of a uniform size, used to provide a non-porous structure for the pit;
- **outer fabric** – non-woven filter fabric (polypropylene geotextile), used to protect the storage media from becoming clogged by the surrounding soil;
- **distribution pipes** – composed of perforated overflow drainage piping, and used to distribute rainwater uniformly throughout the entire pit/trench; and
- **filter layer** – composed of fine sand and placed on the outer fabric on the bottom of the trench to filter impurities prior to infiltration.

### Rainwater quality

To prevent contaminants from entering into the tank, the overflow drainage piping design should be similar to the conveyance network (that is, it should be structurally sound with no points of entry other than those required for water flow). If discharging to grade, the overflow drainage piping should have an insect screen, which is located where it can be inspected and cleaned. If discharging into the storm sewer, a type of check valve, called a 'backwater valve,' can be installed on the overflow drainage piping to prevent storm sewage from backing up into the tank during intense rainfall events.

<sup>21</sup> Adapted from Stormwater Management Planning and Design Manual, 2003. Ontario Ministry of the Environment, Toronto, ON.

## Rainwater harvesting as part of a stormwater management system

Installing an RWH system for the express purpose of reducing stormwater runoff is a relatively new concept in Canada. An RWH system cannot eliminate the need for other stormwater management systems; however, if rainwater is to be managed on site, RWH can reduce the size and complexity of other lot-level infiltration systems. Similarly, if overflow is discharged into the storm sewer, the rainwater tank can be used in place of a holding tank for detention and controlled release. As shown in figure 6-2, the bottom portion of the tank retains/stores rainwater for later use and the top portion of the tank temporarily detains rainwater and releases it at a predetermined rate through control valves. Excess volumes from extreme events are discharged through the overflow drainage piping.

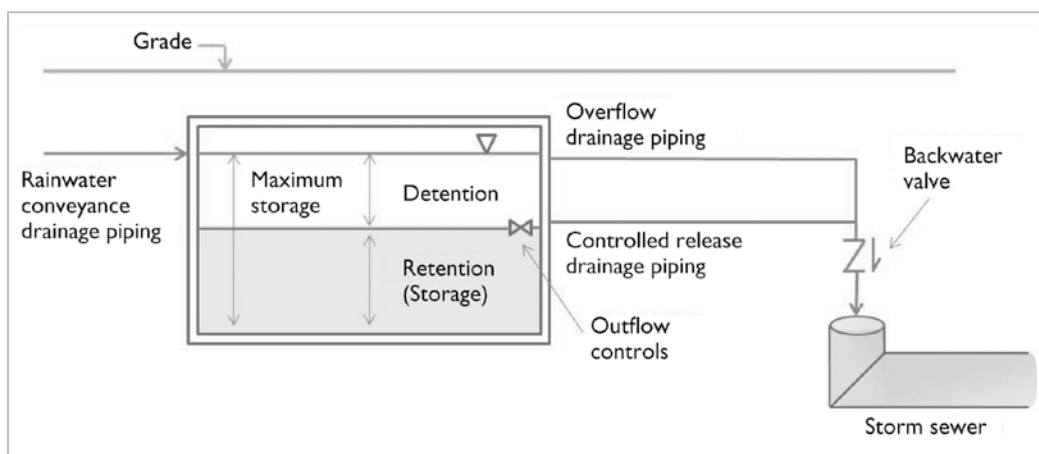

**Figure 6-2** RWH system with outflow controls and controlled release drainage piping for stormwater management. ('DETENTION' is the volume of runoff to be slowly released to storm sewer. The remaining volume 'RETENTION' is used to supply rainwater to permitted fixtures.)

For further guidelines on sizing a rainwater storage tank for both detention and retention, refer to *Appendix D*.

## 6.4 DESIGN AND INSTALLATION GUIDELINES

1. **Determine the overflow discharge location and method.**
  - a. Overflow discharge locations include: grade, storm sewer or soakaway pit.
  - b. Overflow discharge methods include: gravity flow or pump-assisted flow.
  - c. Overflow by pump-assisted flow is not recommended.
  - d. Consult the applicable provincial/territorial codes and regulations, municipal bylaws and local authorities regarding the permitted overflow discharge locations.
  - e. Evaluate the feasibility of the overflow discharge locations.
    - i. Overflow to grade
      1. The overflow discharge location must be at a lower elevation than the flood level rim of the tank for gravity flow to be feasible.
    - ii. Overflow to storm sewer
      1. A storm sewer connection must be present at the site.
      2. The overflow discharge location must be at a lower elevation than the flood level rim of the tank for gravity flow to be feasible.
    - iii. Overflow to soakaway pit
      1. The percolation rate of site soil must be sufficient to permit infiltration of rainwater overflows discharged into the soakaway pit (refer to *Appendix D* for guidelines on sizing soakaway pits).
2. **Plan the layout of the overflow system.**
  - a. Plan route of overflow drainage piping from the tank to the overflow discharge location (refer to *section 1.4 Design and installation guidelines* for guidelines and applicable provincial/territorial codes and regulations regarding drainage piping).
  - b. Contacting the municipality and service providers to ensure that there are no buried service lines (gas, electricity, water, stormwater, wastewater, phone or cable lines) in the area where digging will take place to accommodate buried overflow drainage piping.
3. **Overflow pipes**
  - a. Overflow drainage pipes
    - i. Pipe material
      1. PVC SDR35 pipe or ABS pipe is recommended.
      2. Pipe selected must be approved by applicable provincial/territorial codes and industry standards (CSA, ASTM, etc.).
    - ii. Pipe size and slope
      1. Overflow drainage piping shall be sized to ensure that the capacity of overflow drainage pipes is no less than the capacity of the rainwater conveyance drainage pipes.
      2. Ensure a minimum slope of 0.5-2% (the greater the slope the better) is maintained throughout the pipe length.
    - iii. Tank connection
      1. Overflow drainage piping shall exit the tank at a height no lower than the rainwater conveyance drainage piping, or, ideally, at a height 50 mm [2 in.] below the bottom of the conveyance drainage pipes entering the tank.
    - iv. Consult applicable provincial/territorial codes and regulations pertaining to the installation of drainage piping (refer to *section 1.2 Applicable codes, standards, and guidelines* for details).



**b. Overflow pressure pipes**

**i. Pipe material**

1. Polyethylene pipe is recommended.
2. Pipe selected must be approved by applicable provincial/territorial codes and industry standards (CSA, ASTM, etc.).

**ii. Pipe size and slope**

1. Overflow pressure piping shall be sized to ensure that the capacity of overflow pressure pipes is no less than the capacity of the rainwater conveyance drainage pipes.

**iii. Consult applicable provincial/territorial codes and regulations pertaining to the installation of pressure piping (refer to section 5.2 *Applicable codes, standards, and guidelines* for details).**

**4. Discharging overflow to grade**

- a. Overflow must be discharged at a location where rainwater will not pond or collect around building foundations.
- b. Erosion prevention measures should be taken.
- c. A screen should be installed where the pipe terminates to prevent the entry of birds, rodents and insects.

**5. Discharging overflow to storm sewer**

- a. Overflow drainage piping cannot be directly connected to a storm sewer, unless approved by local authorities.
- b. A direct connection may be permitted if a backwater valve is installed on the overflow drainage pipe. Consult local authorities for approval.
- c. An indirect connection can be made by:
  - i. overflowing to an interceptor tank, which then overflows into the storm sewer;
  - ii. overflowing to a soakaway pit, which then overflows into the storm sewer;
  - iii. overland flow to a sewer grate; or
  - iv. using an air gap in the case of above-ground tanks.

**6. Discharging overflows to a soakaway pit**

- a. Consult applicable provincial/territorial and municipal guidelines regarding the design and installation of soakaway pits.
- b. For guidance purposes only, soakaway pit design and installation guidelines are provided in *Appendix D*.
- c. If there is limited space for a soakaway pit or if the soil has low permeability, it is recommended that the soakaway pit have its own overflow, discharging overflows to grade or into a storm sewer.

**7. Overflow discharge pump**

- a. If rainwater overflows must be pumped, the pump shall be sized to handle the capacity of the rainwater conveyance drainage pipes.
- b. The pump shall be selected and installed in accordance with the guidelines provided in *chapter 5. Pump and pressurized distribution system*.

**8. Incorporating an RWH system as part of a stormwater management system**

- a. Consult the municipality and/or conservation authority regarding how to incorporate an RWH system into other stormwater management systems.
- b. If considering utilizing a rainwater storage tank for both retention and detention purposes, refer to *Appendix D* for further details.

**6.5 MANAGEMENT GUIDELINES**

1. **If the overflow drainage piping discharges above grade, it should be inspected annually.**
  - a. The point at which the overflow discharges should be examined for signs of erosion. A splash pad or several small rocks can be placed at the discharge point to protect the area from future damage.
  - b. The coarse screen at the end of the overflow drainage pipe should be inspected for dirt and debris and, if necessary, cleaned and/or replaced.
  - c. If removing the coarse screen for cleaning or replacement, the inside of the overflow drainage pipe should be inspected for objects or debris that may cause clogging.
2. **If the overflow drainage piping discharges below grade, inspection and/or repair is necessary only when signs of a blocked or poorly performing overflow-handling system are observed, such as:**
  - a. signs of water damage to the rainwater tank, tank lid or access hatch, or components located inside the tank above the maximum water level;
  - b. signs of water leaking from the tank lid or access hatch;
  - c. signs of water backing up rainwater inlet lines and top-up drainage piping; or
  - d. signs of water leaking from downspout-to-conveyance drainage pipe transitions, or from top-up system air gap.
3. **If any of the above signs are observed, the components of the overflow system should be inspected and repaired.**
  - a. Inspect coarse screens located on the overflow drainage pipe for debris that would impede water flow, and clean, repair or replace the coarse screen as necessary.
  - b. Inspect all overflow drainage pipes using a pipe scope for signs of blockages or pipe damage. All debris/blockages must be removed from the overflow drainage piping, and all damaged sections of pipe must be replaced.
  - c. If problems with the overflow system occur during periods of freezing temperatures, it may be necessary to winterize the overflow drainage piping using the methods provided in *chapter 1. Rainwater catchment and conveyance*.
  - d. If the overflow drainage piping discharges into a soakaway pit, the pit may be clogged with dirt and debris and may not be providing sufficient infiltration capacity. It may be necessary to repair and/or expand the pit to accommodate overflow volumes.

- e. If there are no obvious problems with the overflow system, it may be necessary to simulate an overflow event (or observe one during a rainfall event). Monitor the system visually or by pipe scope to determine what is causing the problem.
4. **While inspecting, cleaning or repairing components of the overflow system, follow all necessary safety precautions, including Part XI, Confined Spaces, of the *Canada Occupational Health and Safety Regulations*, if entry into the rainwater storage tank is required (See *chapter 2. Rainwater storage and tank sizing for details*).**



# Appendices



### **Appendix A Rainwater catchment and conveyance**

Collection losses from roof surfaces

Sizing gutters and downspouts

Sizing rainwater conveyance drainage piping

Frost penetration depth and pipe freeze protection

### **Appendix B Rainwater storage and tank sizing**

Rainwater harvesting design tool

Rainwater storage tank sizing tables

### **Appendix C Pump and pressurized distribution system**

Calculation of required pump capacity

Calculation of required pressure from pump (pump head)

Calculation of friction loss

Calculation of pressure tank size

Calculation of pipe size

### **Appendix D Overflow provisions and stormwater management**

Using a rainwater storage tank for retention and detention for stormwater management purposes

Design and sizing of soakaway pits

## Appendix A RAINWATER CATCHMENT AND CONVEYANCE

### Collection losses from roof surfaces

Although 1 L of runoff can theoretically be collected from each millimetre of rainfall contacting a 1-m<sup>2</sup> area, some losses occur following contact with the catchment surface. These losses vary depending on the type of catchment material and the geometry of the roof, and should be considered when estimating the amount of rainwater that can be collected by the RWH system. Losses for various roof catchment materials are listed in table A-1.

**Table A-1** Collection efficiency (loss factors) associated with various roof catchments<sup>22,23</sup>

Roof catchment material	Initial rainfall loss factor (mm)	Continuous rainfall loss ratio (%)
<b>Steel roof</b>	0.25	20.0
<b>Asphalt shingle roof</b>	0.5	20.0
<b>Fiberglass roof</b>	0.5	20.0
<b>Asphalt built-up flat roof</b>	1.5	20.0
<b>Hypalon (rubber) flat roof</b>	1.5	20.0

### Sizing gutters and downspouts

*Note: The guidelines for sizing gutters and downspouts provided in section 1.4 Design and installation guidelines are reproduced below to assist with following the example provided. The detailed example is located following the reproduced guidelines.*

- I. To determine the size of gutter required for a given roof drainage area:
  - a. consult applicable provincial/territorial codes and regulations pertaining to the design rainfall intensity for the site location (refer to section 1.2 Applicable codes, standards, and guidelines for details); and
  - b. calculate the area of roof draining into the gutter:

$$\text{Roof drainage area (m}^2\text{)} = \text{Length (m)} \times \text{Width (m)}$$

Equation A-1

**Where:** *Length* = length of the gutter served by a downspout (m)  
*Width* = distance from the eave to the ridge of the roof drainage area served (m)

<sup>22</sup> DIN 1989-1:2001-10. DIN 1989 Rainwater Harvesting Systems - Part 1: Planning, Installation, Operation and Maintenance. 2002. Fachvereinigung Betriebs- und Regenwassernutzung e.V. fbr; Darmstadt, Germany

<sup>23</sup> Building Capacity for Rainwater Harvesting in Ontario: Rainwater Quality and Performance of RWH Systems. 2008. Despins, C. M.Sc.Thesis, University of Guelph

- c. Refer to table A-2 to determine the minimum size of gutter required based on the roof drainage area (m<sup>2</sup>) and design rainfall intensity values determined above.

**Table A-2** Minimum gutter sizes for given roof drainage areas and rainfall intensities<sup>24</sup>

Minimum required gutter size and type	Maximum roof drainage area served per downspout (m <sup>2</sup> ) <sup>1,2</sup>							
	Design rainfall intensity (15 min rainfall, mm):							
	18.75	25	31.25	37.5	43.75	50	56.25	62.5
<b>100 mm [4 in.] K-style</b>	71	53	43	35	30	27	24	21
<b>125 mm [5 in.] K-style</b>	130	98	78	65	56	49	43	39
<b>150 mm [6 in.] K-style</b>	212	159	127	106	91	79	71	64

<sup>1</sup> Minimum required gutter size assumes that gutters have a minimum slope (≤ 6.25%). For greater gutter slopes, the table values may be multiplied by 1.1.

<sup>2</sup> Maximum roof drainage area assumed roof slopes ≤ 5:12. For steeper roof pitches, multiply the table values by 0.85.

- d. For other gutter types and/or larger roof drainage areas, consult the gutter manufacturer or contractor regarding gutter sizing.

**2. To determine the size of downspout required**

- a. Refer to table A-5 to determine the minimum size of downspout (either rectangular type or square type) based on the size of gutter the downspout is serving.

**Table A-3** Minimum downspout sizes for given gutter sizes<sup>25</sup>

Gutter size and type	Minimum downspout size ( mm [in.] )	
	Rectangular type	Square-type
<b>100 mm [4 in.] K-style</b>	50 x 75 [2 x 3]	75 x 75 [3 x 3]
<b>125 mm [5 in.] K-style</b>	50 x 75 [2 x 3]	75 x 75 [3 x 3]
<b>150 mm [6 in.] K-style</b>	75 x 100 [3 x 4]	100 x 100 [4 x 4]

- b. For other downspout types and/or larger gutter sizes, consult the gutter/downspout manufacturer or contractor regarding downspout sizing.

<sup>24</sup> Adapted from Moisture Resistant Homes: A Best Practice Guide and Plan Review Tool for Builders and Designers. 2006. U.S. Department of Housing and Urban Development, Washington, D.C.

<sup>25</sup> Adapted from Moisture Resistant Homes: A Best Practice Guide and Plan Review Tool for Builders and Designers. 2006. U.S. Department of Housing and Urban Development, Washington, D.C.

■ Example:

For a house located in Saskatoon, SK, with a roof with the peaks and roof pitch illustrated in figure A-1 and figure A-2:

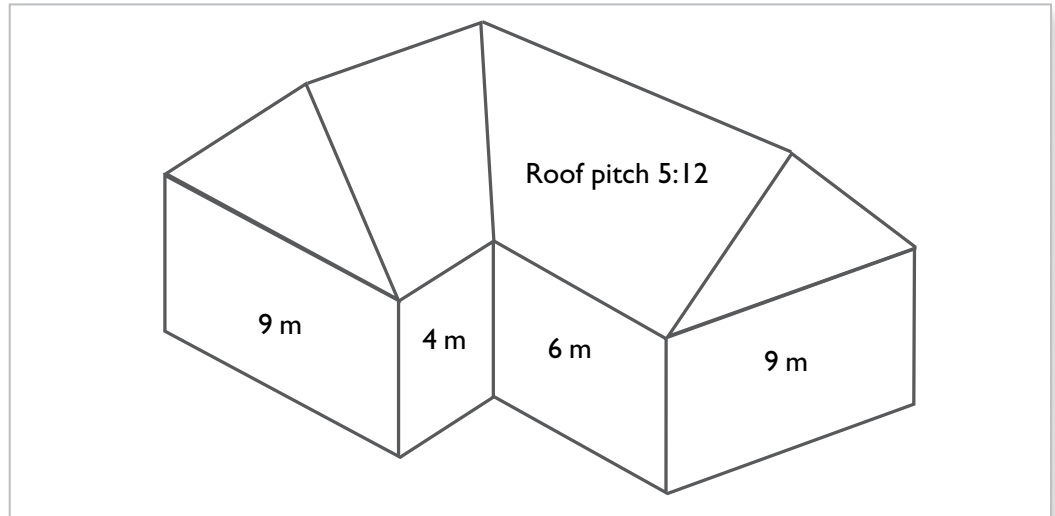

**Figure A-1** Roof drainage area to be guttered (isometric 'facing' view)<sup>26</sup>

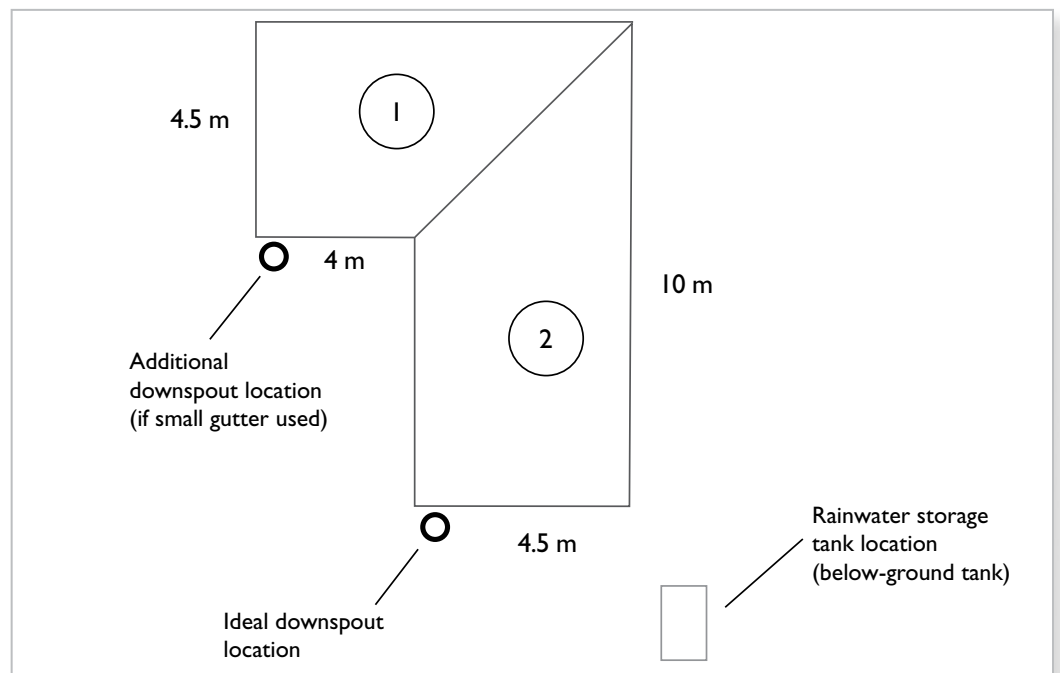

**Figure A-2** Roof drainage area to be guttered (projected 'top-down' view)<sup>27</sup>

<sup>26</sup> Adapted from Moisture Resistant Homes: A Best Practice Guide and Plan Review Tool for Builders and Designers. 2006. U.S. Department of Housing and Urban Development, Washington, D.C.

<sup>27</sup> Adapted from Moisture Resistant Homes: A Best Practice Guide and Plan Review Tool for Builders and Designers. 2006. U.S. Department of Housing and Urban Development, Washington, D.C.



From the National Building Code Division B, Appendix C – table C-2 (refer to section 1.2 *Applicable codes, standards and guidelines* for details).

**Design rainfall intensity (15 min rainfall value, mm): 23**

To calculate the roof drainage area:

$$\text{Roof drainage area (m}^2\text{)} = \text{Area 1} + \text{Area 2}$$

$$\text{Area 1} = 4 \text{ m} \times 4.5 \text{ m}$$

$$\text{Area 1} = 18 \text{ m}^2$$

$$\text{Area 2} = 4.5 \text{ m} \times 10 \text{ m}$$

$$\text{Area 2} = 45 \text{ m}^2$$

$$\text{Roof drainage area} = \text{Area 1} + \text{Area 2}$$

$$\text{Roof drainage area} = 18 \text{ m}^2 + 45 \text{ m}^2$$

$$\text{Roof drainage area} = 63 \text{ m}^2$$

Referring to table A-2 (reproduced from table 1-3), the maximum roof drainage area for this section of roof is given in the second column (23 mm rainfall intensity for the City of Saskatoon—rounded up to 25 mm).

**To discharge the entire roof drainage area to one downspout.**

Referring to the second column of table A-2, a 100-mm [4-in.] K-style gutter can be used only to convey rainwater from roof areas up to 53 m<sup>2</sup>, which is less than the drainage area calculated for this residential household—63 m<sup>2</sup>.

By selecting a larger gutter—a 125-mm [5 in.] K-style gutter—all of the drainage area can be discharged into one downspout as this gutter size can convey rainwater from an area up to 78 m<sup>2</sup> (> 63 m<sup>2</sup>).

Referring to table A-3 (reproduced from table 1-4), a 125-mm [5-in.] K-style gutter requires a 50×75 mm [2×3 in.] rectangular-type downspout, or a 75×75 mm [3×3 in.] square-type downspout.

To minimize the length of conveyance drainage piping required the downspout should be located as close as possible to the rainwater storage tank. The ideal location of the downspout is illustrated in figure A-2.

***To discharge the roof drainage area to more than one downspout.***

Referring to the second column of table A-2, a 100-mm [4-in.] K-style gutter can be used—but additional downspouts are required because the roof drainage area considered is greater than the maximum roof drainage area served per downspout (by one downspout).

To calculate the number of downspouts required:

$$\text{Number of downspouts} = \frac{\text{Roof drainage area}}{\text{Max roof drainage area served per downspout}}$$

$$\text{Number of downspouts} = \frac{63 \text{ m}^2}{53 \text{ m}^2}$$

$$\text{Number of downspouts} = 1.2 \text{ (round up to 2)}$$

By selecting a smaller gutter—a 100-mm [4-in.] K-style gutter—the drainage area must be discharged into 1.2 downspouts (rounded up to 2 downspouts).

Referring to table A-3 (reproduced from table I-4), a 100-mm [4-in.] K-style gutter requires a 50×75 mm [2×3 in.] rectangular-type downspout, or a 75×75 mm [3×3 in.] square-type downspout.

In addition to the one downspout located close to the rainwater storage tank (shown in figure A-2 as the 'ideal downspout location'), a second downspout is required. Locating downspouts on interior building corners is not recommended. It should, therefore, be placed at the corner closest to the rainwater storage tank (See figure A-2).

### **Sizing rainwater conveyance drainage piping**

---

- I. Table A-4 and table A-5 can be used as a conservative estimate of the size of the conveyance drainage piping required for different catchment areas (consult applicable provincial/territorial codes and regulations to verify required conveyance pipe size).

Province	Roof Area (m <sup>2</sup> )																			
	0	50	100	150	200	250	300	350	400	450	500	550	600	650	700	750	800	850	900	950
British Columbia		4	4	4	4	4	4	4	4	6	6	6	6	6	6	6	6	6	6	6
Alberta		4	4	4	4	4	4	4	4	6	6	6	6	6	6	6	6	6	6	6
Saskatchewan		4	4	4	4	4	4	4	4	6	6	6	6	6	6	6	6	6	6	6
Manitoba		4	4	4	4	4	4	4	4	6	6	6	6	6	6	6	6	6	6	6
Ontario		4	4	4	4	4	4	4	4	6	6	6	6	6	6	6	6	6	6	6
Quebec		4	4	4	4	4	4	4	4	6	6	6	6	6	6	6	6	6	6	6
New Brunswick		4	4	4	4	4	4	4	4	6	6	6	6	6	6	6	6	6	6	6
Nova Scotia		4	4	4	4	4	4	4	4	6	6	6	6	6	6	6	6	6	6	6
Prince Edward Island		4	4	4	4	4	4	4	4	6	6	6	6	6	6	6	6	6	6	6
Newfoundland		4	4	4	4	4	4	4	4	6	6	6	6	6	6	6	6	6	6	6
Yukon		4	4	4	4	4	4	4	4	6	6	6	6	6	6	6	6	6	6	6
Northwest Territories		4	4	4	4	4	4	4	4	6	6	6	6	6	6	6	6	6	6	6
Nunavut		4	4	4	4	4	4	4	4	6	6	6	6	6	6	6	6	6	6	6

**Legend**



- 4" Pipe
- 6" Pipe
- 8" Pipe
- 10" Pipe
- 12" Pipe
- 15" Pipe

**Table A-4** Conveyance drainage pipe size requirements for roof areas 50-950 m<sup>2</sup> <sup>28</sup>

<sup>28</sup> Adapted from National Plumbing Code of Canada and National Building Code of Canada 2010. National Research Council of Canada, Ottawa, Ontario. Assumes maximum 15 min rain value for each province and 1% pipe slope.

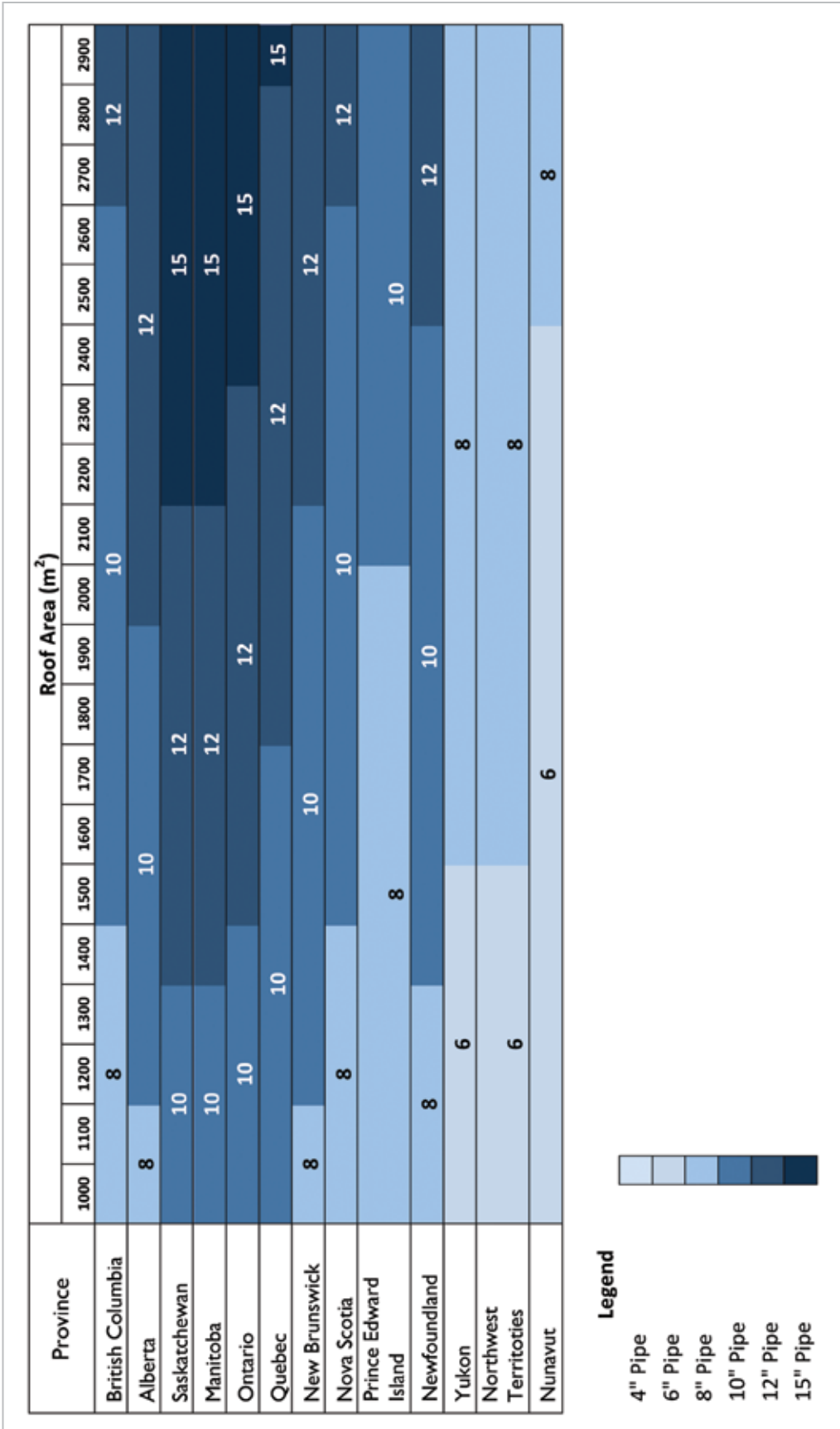
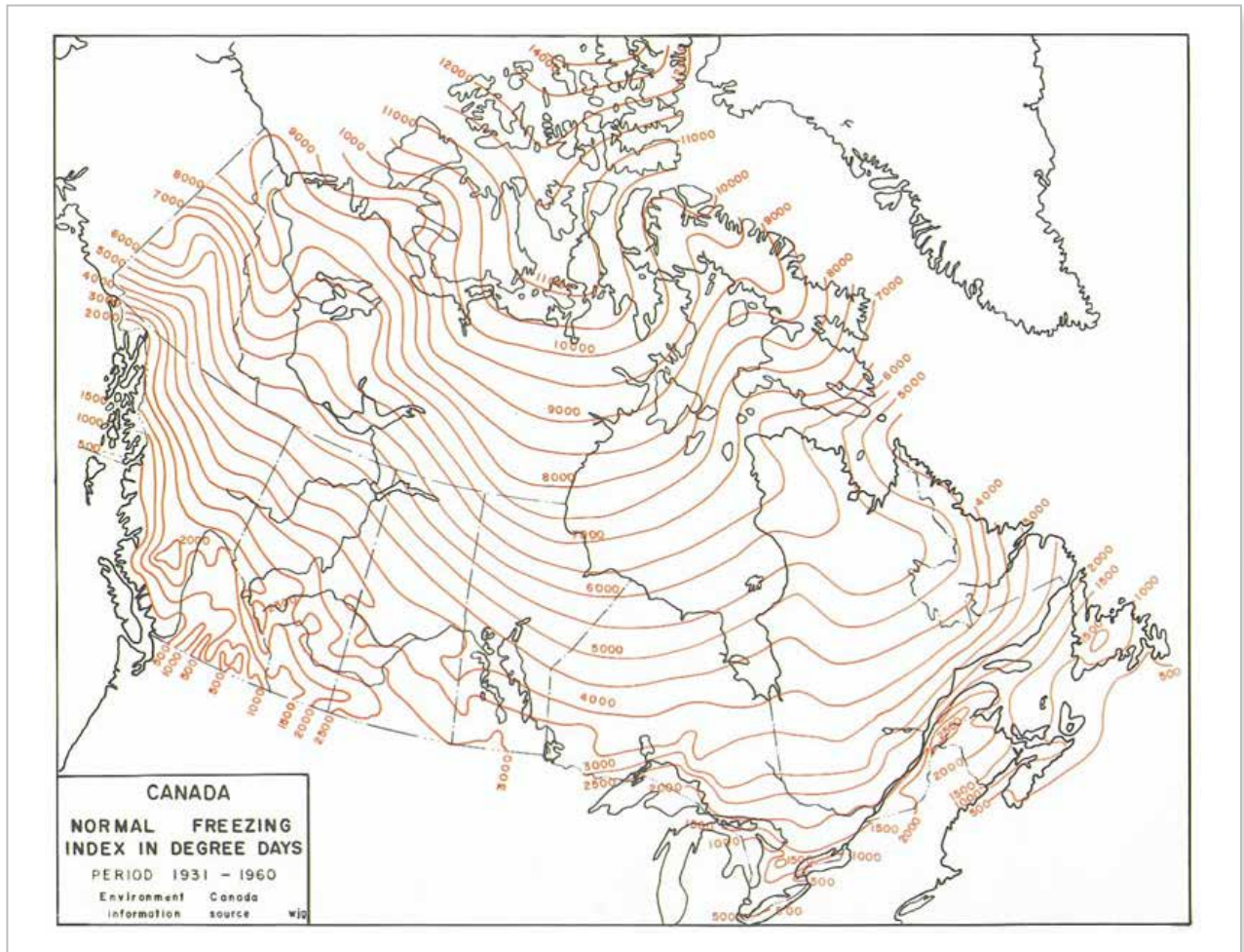

**Table A-5** Conveyance drainage pipe size requirements for roof areas 1000-3000 m<sup>2</sup> <sup>29</sup>

<sup>29</sup> Adapted from National Plumbing Code of Canada and National Building Code of Canada 2010. National Research Council of Canada, Ottawa, Ontario. Assumes maximum 15 min rain value for each province and 1% pipe slope.

## Frost penetration depth and pipe freeze protection

- I. Local frost penetration depths can be estimated using the following method:
  - a. locate the site on the map in figure A-3 and identify the nearest contour line and its associated freezing index value (given in degree days); and
  - b. estimate the frost penetration depth by correlating the degree-day value from figure A-3 to the corresponding depth in table A-6.



**Figure A-3** Normal freezing index for Canada in degree days<sup>30</sup>

<sup>30</sup> Adapted from Canada Normal Freezing Index in Degree Days, Period 1931-1960. Environment Canada, Ottawa, ON.

**Table A-6** Approximate frost depths associated with various freezing index values<sup>31</sup>

Freezing index (Degree days)	Frost depth (m)	Freezing index (Degree days)	Frost depth (m)
<b>400</b>	0.66	<b>2,000</b>	1.98
<b>450</b>	0.71	<b>2,050</b>	2.01
<b>500</b>	0.76	<b>2,100</b>	2.04
<b>550</b>	0.81	<b>2,150</b>	2.07
<b>600</b>	0.86	<b>2,200</b>	2.1
<b>650</b>	0.91	<b>2,250</b>	2.13
<b>700</b>	0.96	<b>2,300</b>	2.16
<b>750</b>	1	<b>2,350</b>	2.19
<b>800</b>	1.05	<b>2,400</b>	2.22
<b>850</b>	1.09	<b>2,450</b>	2.25
<b>900</b>	1.14	<b>2,500</b>	2.28
<b>950</b>	1.18	<b>2,550</b>	2.31
<b>1,000</b>	1.21	<b>2,600</b>	2.34
<b>1,050</b>	1.25	<b>2,650</b>	2.36
<b>1,100</b>	1.29	<b>2,700</b>	2.39
<b>1,150</b>	1.32	<b>2,750</b>	2.42
<b>1,200</b>	1.36	<b>2,800</b>	2.45
<b>1,250</b>	1.39	<b>2,850</b>	2.48
<b>1,300</b>	1.43	<b>2,900</b>	2.51
<b>1,350</b>	1.47	<b>2,950</b>	2.52
<b>1,400</b>	1.5	<b>3,000</b>	2.54
<b>1,450</b>	1.54	<b>3,050</b>	2.56
<b>1,500</b>	1.57	<b>3,100</b>	2.59
<b>1,550</b>	1.62	<b>3,150</b>	2.62
<b>1,600</b>	1.66	<b>3,200</b>	2.64
<b>1,650</b>	1.7	<b>3,250</b>	2.67
<b>1,700</b>	1.74	<b>3,300</b>	2.69
<b>1,750</b>	1.78	<b>3,350</b>	2.72
<b>1,800</b>	1.82	<b>3,400</b>	2.74
<b>1,850</b>	1.86	<b>3,450</b>	2.77
<b>1,900</b>	1.9	<b>3,500</b>	2.79
<b>1,950</b>	1.94	<b>4,000</b>	2.8

<sup>31</sup> Adapted from Ambient Temperatures – Below Ground (Frost Depth). 2009. Urecon Ltd., Saint-Lazare-de-Vaudreuil, Quebec.

**2. To plan layout of conveyance drainage piping for rainwater storage tanks located below grade:**

- a. determine the location of the tank (refer to *chapter 2. Rainwater storage and tank sizing* for guidance)
- b. determine the frost penetration depth by consulting local building authorities regarding regulations or 'rules of thumb' for frost penetration depths. For estimation purposes, refer to the above methods in *Appendix A*;
- c. where possible, rainwater conveyance drainage pipes and the storage tank should be buried below the frost penetration depth. Otherwise, additional freeze protection measures, such as insulation, shall be required; and
- d. to determine whether the conveyance drainage pipes can be buried below the frost penetration depth:

i. determine the final pipe burial depth ( $D_f$ ), where this depth depends on:

1. the local frost penetration depth; and
2. the maximum rated burial depth of the rainwater storage tank.

Where  $D_f$  shall be the lesser of the two values (that is if the tank cannot be buried below the frost penetration depth due to tank burial depth restrictions, then  $D_f$  shall be equal to the tank's max rated burial depth).

ii. determine the initial pipe burial depth ( $D_i$ ), where this depth depends on:

1. the total length of pipe;
2. the slope of pipe;
3. the site grading; and
4. where  $D_i$  can be determined using figure A-4 and equation A-2.

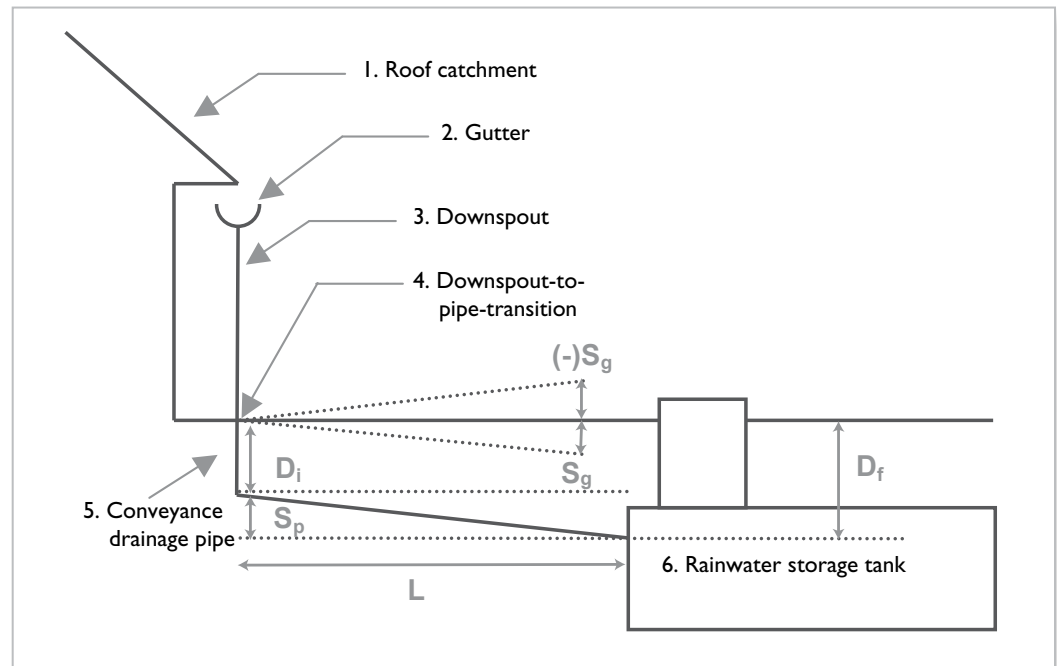

**Figure A-4** Pipe conveyance (profile view)

$$D_i = D_f - L_p S_p + L_g S_g$$

Equation A-2

**Where:**  $D_i$  = Initial pipe burial depth (m)  
 $D_f$  = Final pipe burial depth (m)  
 $L_p$  = Length of pipe (m)  
 $L_g$  = Length of pipe for which there is a grade change (m)  
 $S_p$  = Pipe slope factor (0.01 recommended)  
 $S_g$  = Grade slope factor, assumes downward slope

- iii. If  $D_f$  and/or  $D_i$  is less than the frost penetration depth, then there is a risk of rainwater freezing in the conveyance network. In such cases, repeat the above process, while considering the following:
1. locate the tank in an area with the lowest elevation at the site;
  2. minimize the distance between the furthest downspout and the tank (decrease the horizontal travel distance, H);
  3. increase the burial depth of the tank (ensure that the tank is rated to handle increased burial depth); and/or
  4. reduce the pipe slope to a minimum of 0.5-1%.
- iv. If the conveyance drainage pipe cannot be maintained at or near frost penetration depth, consider insulating the pipe (refer to the method below) or, alternatively, install heat tracing for use during periods of extreme cold.
3. If burial below the frost penetration depth is not feasible, the pipe should be insulated.
- a. Figure A-5 and equation A-3 can be used to estimate the width of insulation required.

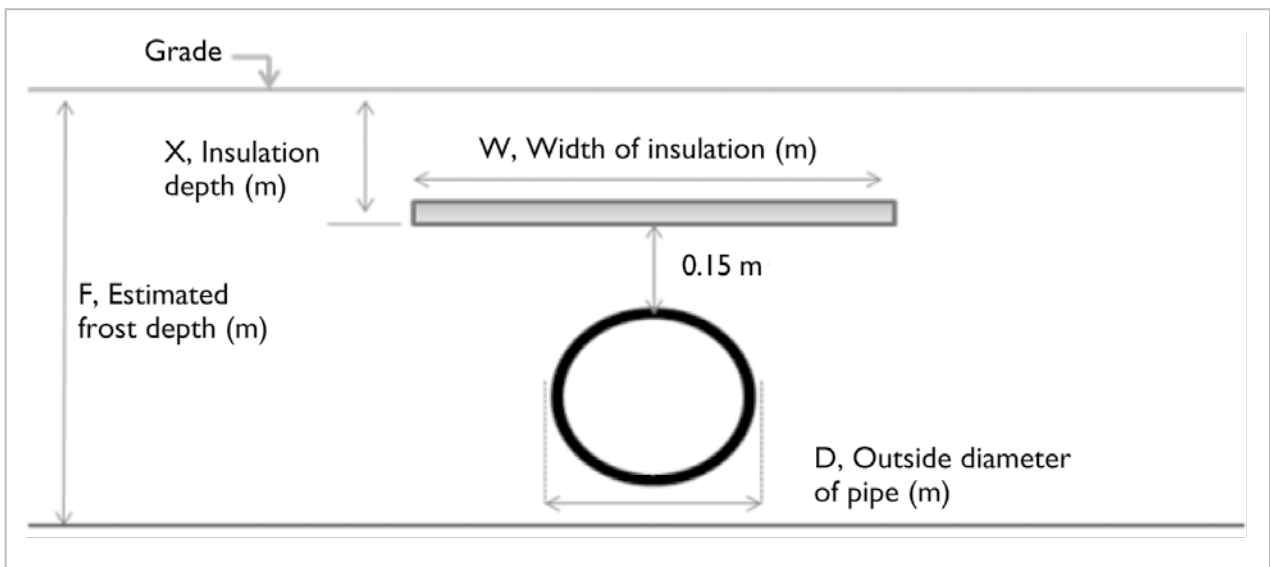

**Figure A-5** Frost protection of pipe by horizontal insulation<sup>32</sup>

<sup>32</sup> Adapted from Ontario's Building Code, 2006. Ministry of Municipal Affairs and Housing, Toronto, ON.



$$W = D + [2 \times (F - X)] - 0.3$$

Equation A-3<sup>33</sup>

**Where:** *W* = width of insulation (m)  
*D* = outside diameter of pipe (m)  
*X* = insulation depth (m)  
*F* = estimated frost depth (m)

b. The thickness of the insulation can be estimated using table A-7:

**Table A-7** Thickness of foam insulation given various pipe burial (backfill) depths<sup>34</sup>

Thickness of foam insulation (mm)							
Amount of backfill over the insulation	Frost depth						
	1.1 m	1.3 m	1.5 m	1.7 m	1.9 m	2.1 m	2.3 m
≤ 0.6 m	50	65	75	90	100	115	125
≤ 0.9 m	40	50	65	75	90	100	115
≤ 1.2 m	25	40	50	65	75	90	100
≤ 1.5 m		25	40	50	65	75	90
≤ 1.8 m				40	50	65	75
≤ 2.1 m					40	50	65

<sup>33</sup> Adapted from Ontario's Building Code, 2006. Ministry of Municipal Affairs and Housing, Toronto, ON.

<sup>34</sup> Adapted from Ontario's Building Code, 2006. Ministry of Municipal Affairs and Housing, Toronto, ON, and Canada Normal Freezing Index in Degree Days, Period 1931-1960. Environment Canada, Ottawa, ON.

## Appendix B RAINWATER STORAGE AND TANK SIZING

*Note: Some of the fixtures listed in this Appendix may not be permitted by the applicable provincial/territorial codes and regulations. Data and examples referencing such fixtures are provided for illustration purposes only.*

### Rainwater harvesting design tool

---

1. For select provinces, rainwater storage tanks can be sized using the *Rainwater harvesting system design tool*, which can be accessed online.
2. Instructions on the use of the Rainwater harvesting system design tool are provided with the design tool software package. Refer to these instructions for further details.

### Rainwater storage tank sizing tables

---

1. **Rainwater storage tanks can be sized using the Tank sizing tables developed using the Rainwater harvesting system design tool. Refer to the appropriate table, based upon the following regions.**
  - a. Table B-3 Maritime Provinces: Newfoundland, Nova Scotia, New Brunswick and Prince Edward Island
  - b. Table B-4 Ontario and Quebec
  - c. Table B-5 Prairie Provinces: Manitoba, Saskatchewan and Alberta
  - d. Table B-6 British Columbia
  - e. *Note: Table B-5 provides tank sizes for the Prairie Provinces, but these tank sizes should also be applicable for Northern regions. In regions where there is less annual rainfall than the City of Edmonton, tanks with larger storage capacities than those listed in table B-5 are recommended.*
2. **Household indoor rainwater demand can be estimated using table B-1 and the following instructions.**
  - a. For each fixture to be supplied with rainwater, determine the fixture type and associated water usage by examining the fixture and/or referring to the manufacturer's product literature.
  - b. Once the fixture type and water usage have been determined, calculate the daily rainwater usage for the fixture by multiplying the water usage (provided by the manufacturer, or using the average figures provided in table B-1) by the number of uses per person per day (provided in table B-1). Multiply the resulting figure by the number of occupants residing in the household.
  - c. Sum these values to determine the total indoor rainwater demand (litres per day).
  - d. Sum the total indoor rainwater demand with the total outdoor rainwater demand, where applicable (refer to table B-2 and the accompanying instructions for assistance on calculating outdoor rainwater usage).

**Table B-1** Household indoor fixtures and associated water usage figures/assumptions<sup>35</sup>

Fixtures	Fixture type	Water usage	Number of uses per person per day	Water usage duration
<b>Toilet</b>	Low flush	13.0 litres/flush	5	
<b>Toilet</b>	Ultra-low flush	6.0 litres/flush	5	
<b>Toilet</b>	Dual-flush/HET	4.8 litres/flush	5	
<b>Laundry</b>	Top-loading	150 litres/load	0.37	
<b>Laundry</b>	Front-loading	100 litres/load	0.37	
<b>Lavatory</b>	Inefficient/old	8.0 litres/minute	3	0.5 minutes
<b>Lavatory</b>	Standard	5.3 litres/minute	3	0.5 minutes
<b>Lavatory</b>	High-efficiency	3.2 litres/minute	3	0.5 minutes
<b>Shower</b>	Inefficient/old	9.5 litres/minute	0.3	5 minutes
<b>Shower</b>	Standard	8.3 litres/minute	0.3	5 minutes
<b>Shower</b>	High-efficiency	5.7 litres/minute	0.3	5 minutes

### ■ Example

For a household of five, using rainwater for toilet flushing and laundry:

- The toilets in the home are the ultra-low flush 6.0 litre per flush type.
- The washing machine is a typical top-loading machine using 150 litres per load.

**Daily rainwater demand (toilets)** = 6.0 litres/flush × 5 flushes per person per day × 5 persons

**Daily rainwater demand (toilets)** = 150 litres/day

**Daily indoor rainwater demand (total)** = 150 litres/day

3. Household outdoor rainwater demand can be estimated using table B-2 and the following instructions.
  - a. For each fixture to be supplied with rainwater, determine the fixture type and associated water usage by examining the fixture and/or referring to the manufacturer's product literature.

<sup>35</sup> Adapted from: Vickers, A. 2001. Handbook of Water Use and Conservation. Water Plow Press. Amherst, MA.

- b. Once the fixture type and water usage have been determined, calculate the weekly rainwater usage:
  - i. for the garden hose by multiplying the water usage (provided by the manufacturer; or using the average figures provided in table B-2) by the number of uses per week and multiplying the resulting figure by the water usage duration (provided in table B-2);
  - ii. for the irrigation system by multiplying the water usage (provided by the manufacturer; or using the average figures provided in table B-2) by the irrigated area (in m<sup>2</sup>), and multiplying the resulting figure by the number of times the irrigation system is used per week (provided in table B-2).
- c. Convert this weekly rainwater usage to a daily usage by dividing the above figure by 7.
- d. Repeat this process for each of the fixtures to be supplied with rainwater, and sum these values to determine the total outdoor rainwater demand (litres per day).
- e. Sum the total outdoor rainwater demand with the total indoor rainwater demand, where applicable (refer to table B-1 and the accompanying instructions for assistance on calculating indoor rainwater usage).

**Table B-2** Household outdoor fixtures and associated water usage figures/assumptions<sup>36</sup>

Fixtures	Fixture type	Water usage	Number of uses per person per day	Water usage duration
<b>Garden hose</b>	Hose with 13 mm [1/2 in.] supply	11 litres/minute	3	30 minutes
<b>Garden hose</b>	Hose with 18 mm [3/4 in.] supply	19 litres/minute	3	30 minutes
<b>Irrigation system</b>	Providing equivalent of 25 mm [1 in.] rainfall per use	25 litres/m <sup>2</sup>	3	
<b>Irrigation system</b>	Providing equivalent of 13 mm [1/2 in.] rainfall per use	12.5 litres/m <sup>2</sup>	3	
<b>Irrigation system</b>	Providing equivalent of 6 mm [1/4 in.] rainfall per use	6 litres/m <sup>2</sup>	3	

#### ■ Example

For a household using rainwater for both a garden hose and an irrigation system:

- the garden hose has a 13 mm [1/2 in.] supply, and is used three times each week, for approximately 30 minutes each time;

<sup>36</sup> Residential Water Systems: Goulds Pumps Technical Data, Water Products. 2007. ITT Corporation, White Plains, N.Y.

- the irrigation system provides the equivalent of 6 mm [ $\frac{1}{4}$  in.] rainfall per use, and has an irrigated area of 50 m<sup>2</sup>.

**Weekly rainwater demand (garden hose)** = 111 Litres/minute  $\times$  30 minutes  $\times$  3 uses  
per week

**Weekly rainwater demand (garden hose)** = 990 litres/week

**Daily rainwater demand (garden hose)** = 1,017 litres/week  $\div$  7 days/week

**Daily rainwater demand (garden hose)** = 141 litres/day

**Weekly rainwater demand (irrigation system)**

= 6 litres/m<sup>2</sup>  $\times$  50 m<sup>2</sup> irrigated area  $\times$  3 uses per week

**Weekly rainwater demand (irrigation system)** = 900 litres/week

**Daily rainwater demand (irrigation system)** = 900 litres/week  $\div$  7 days/week

**Daily rainwater demand (irrigation system)** = 129 litres/day

**Daily outdoor rainwater demand (total)** = 141 litres/day + 129 litres/day

**Daily outdoor rainwater demand (total)** = 270 litres/day

4. Calculate the daily rainwater demand (litres per day) by summing the household indoor rainwater demand and the outdoor rainwater demand.

- **Example**

Summing indoor and outdoor demand:

**Daily rainwater demand (total)** = 150 litres/day + 270 litres/day

**Daily rainwater demand (total)** = 420 litres/day

5. Refer to the appropriate tank sizing table to find the recommended tank size using the daily rainwater demand (litres per day) and the roof catchment area (m<sup>2</sup>).

6. **Note: How were tank sizing table recommended storage volumes determined?**

- a. For each unique combination of daily rainwater demand and roof catchment area (that is, for an RWH system with a rainwater demand of 50 litres/day and a roof catchment area of 100 m<sup>2</sup>) rainwater storage tanks of increasing storage capacities were modelled using the Rainwater harvesting design tool.
- b. While comparing multiple tanks, if a tank with a larger storage capacity provided a significant increase in the water savings provided by the RWH system, compared to a smaller tank, the design tool recommended the larger tank.
- c. This process was repeated with increasing storage tank volumes until the water savings increase provided by the larger tank was considered to be insignificant.
- d. The criterion that was used to distinguish between significant and insignificant was as follows:
  - i. if larger tank provides  $\geq$  2.5% increase in water savings per 1,000 litres, select larger tank and continue process to examine the water savings of subsequent larger tanks; and
  - ii. if larger tank provides  $<$  2.5% increase in water savings per 1,000 litres, do not consider the tank, and recommend the largest storage tank that met the  $\geq$  2.5% criterion.

Rainwater Demand (litres per day)	Optimum Rainwater Cistern Capacity (L)																			
	Roof Catchment Area (m <sup>2</sup> )																			
	50	100	150	200	250	300	350	400	450	500	600	700	800	900	1,000	1,500	2,000	2,500	3,000	
50	2,000	2,000	2,000	2,000	2,000	2,000	2,000	2,000	2,000	2,000	2,000	2,000	2,000	2,000	2,000	2,000	2,000	2,000	2,000	2,000
100	4,000	2,000	2,000	2,000	2,000	2,000	2,000	2,000	2,000	2,000	2,000	2,000	2,000	2,000	2,000	2,000	2,000	2,000	2,000	2,000
150	4,000	4,000	4,000	4,000	4,000	4,000	4,000	4,000	4,000	4,000	4,000	4,000	4,000	4,000	4,000	4,000	4,000	4,000	4,000	4,000
200	4,000	5,000	5,000	4,000	4,000	4,000	4,000	4,000	4,000	4,000	4,000	4,000	4,000	4,000	4,000	4,000	4,000	4,000	4,000	4,000
250	4,000	5,000	5,000	5,000	5,000	4,000	4,000	4,000	4,000	4,000	4,000	4,000	4,000	4,000	4,000	4,000	4,000	4,000	4,000	4,000
300	4,000	7,500	7,500	7,500	5,000	5,000	5,000	4,000	4,000	4,000	4,000	4,000	4,000	4,000	4,000	4,000	4,000	4,000	4,000	4,000
350	4,000	7,500	7,500	7,500	7,500	7,500	5,000	5,000	5,000	5,000	5,000	5,000	5,000	5,000	5,000	5,000	5,000	5,000	5,000	5,000
400	4,000	7,500	7,500	7,500	7,500	7,500	7,500	5,000	5,000	5,000	5,000	5,000	5,000	5,000	5,000	5,000	5,000	5,000	5,000	5,000
450	4,000	7,500	7,500	7,500	7,500	7,500	7,500	7,500	7,500	5,000	5,000	5,000	5,000	5,000	5,000	5,000	5,000	5,000	5,000	5,000
500	4,000	7,500	7,500	7,500	7,500	7,500	7,500	7,500	7,500	7,500	5,000	5,000	5,000	5,000	5,000	5,000	5,000	5,000	5,000	5,000
600	4,000	7,500	7,500	7,500	7,500	7,500	7,500	7,500	7,500	7,500	7,500	5,000	5,000	5,000	5,000	5,000	5,000	5,000	5,000	5,000
700	4,000	7,500	7,500	10,000	10,000	10,000	10,000	10,000	10,000	10,000	10,000	10,000	7,500	7,500	7,500	7,500	7,500	7,500	7,500	5,000
800	4,000	7,500	7,500	10,000	10,000	10,000	10,000	10,000	10,000	10,000	10,000	10,000	7,500	7,500	7,500	7,500	7,500	7,500	7,500	7,500
900	4,000	7,500	7,500	10,000	10,000	10,000	10,000	10,000	10,000	10,000	10,000	10,000	7,500	7,500	7,500	7,500	7,500	7,500	7,500	7,500
1,000	4,000	7,500	7,500	10,000	10,000	10,000	10,000	10,000	10,000	10,000	10,000	10,000	7,500	7,500	7,500	7,500	7,500	7,500	7,500	7,500
1,500	4,000	7,500	7,500	10,000	10,000	10,000	10,000	10,000	10,000	10,000	10,000	10,000	10,000	10,000	10,000	10,000	10,000	10,000	10,000	10,000
2,000	4,000	7,500	7,500	10,000	10,000	10,000	10,000	10,000	10,000	10,000	10,000	10,000	10,000	10,000	10,000	10,000	10,000	10,000	10,000	10,000
2,500	4,000	7,500	7,500	10,000	10,000	10,000	10,000	10,000	10,000	10,000	10,000	10,000	10,000	10,000	10,000	10,000	10,000	10,000	10,000	10,000
3,000	4,000	7,500	7,500	10,000	10,000	10,000	10,000	10,000	10,000	10,000	10,000	10,000	10,000	10,000	10,000	10,000	10,000	10,000	10,000	10,000

**Table B-3** Maritime Provinces – Recommended storage tank capacities for catchment areas and rainwater demands for RWH systems

Recommended rainwater storage tank capacities generated using the Rainwater harvesting system design tool assuming:

- historical rainfall for St. John's, NL, from 1950-2005 (median annual rainfall: 1,156 mm); and
- optimum rainwater storage tank capacity values include an assumption of a 20% unused volume (typically referred to as 'dead space').



Rainwater Demand (litres per day)	Optimum Rainwater Cistern Capacity (L)																			
	Roof Catchment Area (m <sup>2</sup> )																			
	50	100	150	200	250	300	350	400	450	500	600	700	800	900	1,000	1,500	2,000	2,500	3,000	
50	2,000	2,000	2,000	2,000	2,000	2,000	2,000	2,000	2,000	2,000	2,000	2,000	2,000	2,000	5,000	5,000	5,000	5,000	5,000	5,000
100	2,000	2,000	2,000	2,000	2,000	2,000	2,000	2,000	2,000	2,000	2,000	2,000	2,000	2,000	5,000	5,000	5,000	5,000	5,000	5,000
150	2,000	4,000	4,000	4,000	4,000	4,000	4,000	4,000	4,000	4,000	4,000	4,000	4,000	4,000	5,000	5,000	5,000	5,000	5,000	5,000
200	2,000	5,000	5,000	5,000	5,000	5,000	5,000	5,000	5,000	5,000	5,000	5,000	5,000	5,000	5,000	5,000	5,000	5,000	5,000	5,000
250	2,000	5,000	5,000	7,500	7,500	7,500	7,500	7,500	7,500	7,500	7,500	7,500	7,500	7,500	7,500	7,500	7,500	7,500	7,500	7,500
300	2,000	5,000	5,000	7,500	7,500	7,500	7,500	7,500	7,500	7,500	7,500	7,500	7,500	7,500	7,500	7,500	7,500	7,500	7,500	7,500
350	-	5,000	5,000	7,500	7,500	7,500	7,500	7,500	7,500	7,500	7,500	7,500	7,500	7,500	7,500	7,500	7,500	7,500	7,500	7,500
400	-	5,000	5,000	7,500	7,500	7,500	7,500	7,500	7,500	7,500	7,500	7,500	7,500	7,500	7,500	7,500	7,500	7,500	7,500	7,500
450	-	5,000	5,000	7,500	7,500	7,500	7,500	7,500	7,500	7,500	7,500	7,500	7,500	7,500	7,500	7,500	7,500	7,500	7,500	7,500
500	-	5,000	5,000	7,500	7,500	7,500	7,500	7,500	7,500	7,500	7,500	7,500	7,500	7,500	7,500	7,500	7,500	7,500	7,500	7,500
600	-	5,000	5,000	7,500	7,500	7,500	7,500	7,500	7,500	7,500	7,500	7,500	7,500	7,500	7,500	7,500	7,500	7,500	7,500	7,500
700	-	5,000	5,000	7,500	7,500	7,500	7,500	7,500	7,500	7,500	7,500	7,500	7,500	7,500	7,500	7,500	7,500	7,500	7,500	7,500
800	-	5,000	5,000	7,500	7,500	7,500	7,500	7,500	7,500	7,500	7,500	7,500	7,500	7,500	7,500	7,500	7,500	7,500	7,500	7,500
900	-	-	5,000	7,500	7,500	7,500	7,500	7,500	7,500	7,500	7,500	7,500	7,500	7,500	7,500	7,500	7,500	7,500	7,500	7,500
1,000	-	-	5,000	7,500	7,500	7,500	7,500	7,500	7,500	7,500	7,500	7,500	7,500	7,500	7,500	7,500	7,500	7,500	7,500	7,500
1,500	-	-	5,000	7,500	7,500	7,500	7,500	7,500	7,500	7,500	7,500	7,500	7,500	7,500	7,500	7,500	7,500	7,500	7,500	7,500
2,000	-	-	5,000	7,500	7,500	7,500	7,500	7,500	7,500	7,500	7,500	7,500	7,500	7,500	7,500	7,500	7,500	7,500	7,500	7,500
2,500	-	-	-	7,500	7,500	7,500	7,500	7,500	7,500	7,500	7,500	7,500	7,500	7,500	7,500	7,500	7,500	7,500	7,500	7,500
3,000	-	-	-	7,500	7,500	7,500	7,500	7,500	7,500	7,500	7,500	7,500	7,500	7,500	7,500	7,500	7,500	7,500	7,500	7,500

**Table B-4** Ontario and Quebec – Recommended storage tank capacities for catchment areas and rainwater demands for RWH systems

Recommended rainwater storage tank capacities generated using the Rainwater harvesting system design tool assuming:

- historical rainfall for Toronto, ON, from 1961-2005 (median annual rainfall: 678 mm); and
- optimum rainwater storage tank capacity values include an assumption of a 20% unused volume (typically referred to as 'dead space').

Rainwater Demand (litres per day)		Optimum Rainwater Cistern Capacity (L)																		
		Roof Catchment Area (m <sup>2</sup> )																		
		50	100	150	200	250	300	350	400	450	500	600	700	800	900	1,000	1,500	2,000	2,500	3,000
50	2,000	2,000	2,000	2,000	2,000	2,000	2,000	2,000	2,000	2,000	2,000	2,000	2,000	2,000	2,000	2,000	2,000	2,000	2,000	2,000
100	2,000	4,000	4,000	4,000	4,000	4,000	4,000	4,000	4,000	4,000	4,000	4,000	4,000	4,000	4,000	4,000	4,000	4,000	4,000	4,000
150	2,000	4,000	4,000	4,000	4,000	4,000	4,000	4,000	4,000	4,000	4,000	4,000	4,000	4,000	4,000	4,000	4,000	4,000	4,000	4,000
200	2,000	4,000	4,000	4,000	4,000	4,000	4,000	4,000	4,000	4,000	4,000	4,000	4,000	4,000	4,000	4,000	4,000	4,000	4,000	4,000
250	-	4,000	4,000	4,000	4,000	4,000	4,000	4,000	4,000	4,000	4,000	4,000	4,000	4,000	4,000	4,000	4,000	4,000	4,000	4,000
300	-	4,000	4,000	4,000	4,000	4,000	4,000	4,000	4,000	4,000	4,000	4,000	4,000	4,000	4,000	4,000	4,000	4,000	4,000	4,000
350	-	4,000	4,000	4,000	4,000	4,000	4,000	4,000	4,000	4,000	4,000	4,000	4,000	4,000	4,000	4,000	4,000	4,000	4,000	4,000
400	-	4,000	4,000	4,000	4,000	4,000	4,000	4,000	4,000	4,000	4,000	4,000	4,000	4,000	4,000	4,000	4,000	4,000	4,000	4,000
450	-	4,000	4,000	4,000	4,000	4,000	4,000	4,000	4,000	4,000	4,000	4,000	4,000	4,000	4,000	4,000	4,000	4,000	4,000	4,000
500	-	-	4,000	4,000	4,000	4,000	4,000	4,000	4,000	4,000	4,000	4,000	4,000	4,000	4,000	4,000	4,000	4,000	4,000	4,000
600	-	-	4,000	4,000	4,000	4,000	4,000	4,000	4,000	4,000	4,000	4,000	4,000	4,000	4,000	4,000	4,000	4,000	4,000	4,000
700	-	-	4,000	4,000	4,000	4,000	4,000	4,000	4,000	4,000	4,000	4,000	4,000	4,000	4,000	4,000	4,000	4,000	4,000	4,000
800	-	-	4,000	4,000	4,000	4,000	4,000	4,000	4,000	4,000	4,000	4,000	4,000	4,000	4,000	4,000	4,000	4,000	4,000	4,000
900	-	-	4,000	4,000	4,000	4,000	4,000	4,000	4,000	4,000	4,000	4,000	4,000	4,000	4,000	4,000	4,000	4,000	4,000	4,000
1,000	-	-	4,000	4,000	4,000	4,000	4,000	4,000	4,000	4,000	4,000	4,000	4,000	4,000	4,000	4,000	4,000	4,000	4,000	4,000
1,500	-	-	-	-	4,000	4,000	4,000	4,000	4,000	4,000	4,000	4,000	4,000	4,000	4,000	4,000	4,000	4,000	4,000	4,000
2,000	-	-	-	-	-	4,000	4,000	4,000	4,000	4,000	4,000	4,000	4,000	4,000	4,000	4,000	4,000	4,000	4,000	4,000
2,500	-	-	-	-	-	-	4,000	4,000	4,000	4,000	4,000	4,000	4,000	4,000	4,000	4,000	4,000	4,000	4,000	4,000
3,000	-	-	-	-	-	-	-	4,000	4,000	4,000	4,000	4,000	4,000	4,000	4,000	4,000	4,000	4,000	4,000	4,000

**Table B-5** Prairie Provinces – Recommended storage tank capacities for catchment areas and rainwater demands for RWH systems

Recommended rainwater storage tank capacities generated using the Rainwater harvesting system design tool assuming:

- historical rainfall for Edmonton, AB, from 1961-2005 (median annual rainfall: 346 mm); and
- optimum rainwater storage tank capacity values include an assumption of a 20% unused volume (typically referred to as 'dead space').



Rainwater Demand (litres per day)	Optimum Rainwater Cistern Capacity (L)																			
	Roof Catchment Area (m <sup>2</sup> )																			
	50	100	150	200	250	300	350	400	450	500	600	700	800	900	1,000	1,500	2,000	2,500	3,000	
50	2,000	2,000	2,000	2,000	2,000	2,000	2,000	2,000	2,000	2,000	2,000	2,000	2,000	2,000	2,000	5,000	5,000	5,000	5,000	5,000
100	4,000	4,000	4,000	4,000	2,000	2,000	2,000	2,000	2,000	2,000	2,000	2,000	2,000	2,000	2,000	5,000	5,000	5,000	5,000	5,000
150	4,000	5,000	5,000	4,000	4,000	4,000	4,000	4,000	4,000	4,000	4,000	4,000	4,000	4,000	4,000	5,000	5,000	5,000	5,000	5,000
200	4,000	5,000	7,500	7,500	5,000	5,000	5,000	5,000	5,000	5,000	4,000	4,000	4,000	4,000	5,000	5,000	5,000	5,000	5,000	5,000
250	4,000	5,000	7,500	7,500	7,500	7,500	7,500	7,500	7,500	7,500	7,500	7,500	7,500	7,500	7,500	5,000	5,000	5,000	5,000	5,000
300	4,000	5,000	7,500	7,500	7,500	7,500	7,500	7,500	7,500	7,500	7,500	7,500	7,500	7,500	7,500	5,000	5,000	5,000	5,000	5,000
350	4,000	5,000	7,500	7,500	7,500	7,500	7,500	7,500	7,500	7,500	7,500	7,500	7,500	7,500	7,500	7,500	7,500	7,500	7,500	5,000
400	4,000	5,000	7,500	7,500	7,500	7,500	7,500	7,500	7,500	7,500	7,500	7,500	7,500	7,500	7,500	7,500	7,500	7,500	7,500	7,500
450	4,000	5,000	7,500	7,500	7,500	7,500	7,500	7,500	7,500	7,500	7,500	7,500	7,500	7,500	7,500	7,500	7,500	7,500	7,500	7,500
500	4,000	5,000	7,500	7,500	7,500	7,500	7,500	7,500	7,500	7,500	7,500	7,500	7,500	7,500	7,500	7,500	7,500	7,500	7,500	7,500
600	4,000	5,000	7,500	7,500	7,500	7,500	7,500	7,500	7,500	7,500	7,500	7,500	7,500	7,500	7,500	7,500	7,500	7,500	7,500	7,500
700	4,000	5,000	7,500	7,500	7,500	7,500	7,500	7,500	7,500	7,500	7,500	7,500	7,500	7,500	7,500	7,500	7,500	7,500	7,500	7,500
800	4,000	5,000	7,500	7,500	7,500	7,500	7,500	7,500	7,500	7,500	7,500	7,500	7,500	7,500	7,500	7,500	7,500	7,500	7,500	7,500
900	4,000	5,000	7,500	7,500	7,500	7,500	7,500	7,500	7,500	7,500	7,500	7,500	7,500	7,500	7,500	7,500	7,500	7,500	7,500	7,500
1,000	4,000	5,000	7,500	7,500	7,500	7,500	7,500	7,500	7,500	7,500	7,500	7,500	7,500	7,500	7,500	7,500	7,500	7,500	7,500	7,500
1,500	4,000	5,000	7,500	7,500	7,500	7,500	7,500	7,500	7,500	7,500	7,500	7,500	7,500	7,500	7,500	7,500	7,500	7,500	7,500	7,500
2,000	4,000	5,000	7,500	7,500	7,500	7,500	7,500	7,500	7,500	7,500	7,500	7,500	7,500	7,500	7,500	7,500	7,500	7,500	7,500	7,500
2,500	4,000	5,000	7,500	7,500	7,500	7,500	7,500	7,500	7,500	7,500	7,500	7,500	7,500	7,500	7,500	7,500	7,500	7,500	7,500	7,500
3,000	4,000	5,000	7,500	7,500	7,500	7,500	7,500	7,500	7,500	7,500	7,500	7,500	7,500	7,500	7,500	7,500	7,500	7,500	7,500	7,500

**Table B-6** British Columbia – Recommended storage tank capacities for catchment areas and rainwater demands for RWH systems

Recommended rainwater storage tank capacities generated using the Rainwater harvesting system design tool assuming:

- historical rainfall for Vancouver, BC, from 1950-2005 (median annual rainfall: 1,102 mm); and
- optimum rainwater storage tank capacity values include an assumption of a 20% unused volume (typically referred to as 'dead space').

## Appendix C PUMP AND PRESSURIZED DISTRIBUTION SYSTEM

*Note: Some of the fixtures listed in this Appendix may not be permitted by the applicable provincial/territorial codes and regulations. Data and examples referencing such fixtures are provided for illustration purposes only.*

### Calculation of required pump capacity

- I. For estimation purposes only, the maximum peak demand (minimum recommended pump flow rate) can be calculated using table C-1, table C-2 and methods below. *Note that this method is an industry standard method—be sure to consult local building authorities to ensure that the flow rates below are permitted for the fixtures served by the rainwater harvesting system.*

**Table C-1** Minimum recommended waterflow rate for various indoor fixtures<sup>37</sup>

Indoor fixtures	Minimum flow rate (per fixture)
<b>Shower or bathtub</b>	19 LPM [5 GPM]
<b>Lavatory</b>	1 LPM [0.3 GPM]
<b>Toilet</b>	2.7 LPM [0.7 GPM]
<b>Kitchen sink</b>	1.6 LPM [0.4 GPM]
<b>Washing machine</b>	19 LPM [5 GPM]
<b>Dishwasher</b>	7.6 LPM [2 GPM]

**Table C-2** Minimum recommended waterflow rate for various outdoor fixtures<sup>38</sup>

Outdoor fixtures	Minimum flow rate (per fixture)
<b>Garden hose with 13 mm [1/2 in.] supply</b>	11 LPM [3 GPM]
<b>Garden hose with 18 mm [3/4 in.] supply</b>	19 LPM [6 GPM]
<b>Irrigation system</b>	Varies (Consult supplier / contractor)

<sup>37</sup> Adapted from Residential Water Systems: Goulds Pumps Technical Data, Water Products. 2007. ITT Corporation, White Plains, N.Y. (flow rates from Jet and Submersible Pump Selection for Private Residences table, total usage column values ÷ 7).

<sup>38</sup> Adapted from Residential Water Systems: Goulds Pumps Technical Data, Water Products. 2007. ITT Corporation, White Plains, N.Y. (flow rates from Yard Fixtures table).

■ **Example**

Using table C-1, if a given pump and pressure system must provide rainwater to three toilets, a washing machine and hose bib, the maximum peak demand can be determined as follows:

**Table C-3** Example calculation—sizing maximum peak demand

Indoor fixtures	Number of fixtures	Minimum flow rate (per fixture)	Total flow rate
<b>Toilet</b>	3	2.7 LPM	8.1 LPM
<b>Washing machine</b>	1	19 LPM	19 LPM
<b>Hose watering (1/2 in. supply)</b>	1	11 LPM	11 LPM
<b>Maximum peak demand</b>			<b>38 LPM</b>

As shown in table C-3, the total water usage is determined by multiplying the number of fixtures by the minimum flow rate for each fixture, and summed for all types of fixtures to estimate the maximum peak demand.

For the above application, a pump providing a minimum flow rate of 38 LPM [10 GPM] is recommended

### Calculation of required pressure from pump (pump head)

- I. The pump head can be calculated using the following equations:
  - a. Pump head (m or ft.) = Required system pressure + Total dynamic head

**Where:** *Required system pressure is the operating pressure required for the rainwater fixtures (275-415 kPa [-40-60 psi] for typical residential applications). Pressure can be converted from kPa or psi to m or ft. using table C-4:*

**Table C-4** Conversion factors for 'kPa' and 'psi'

	Pressure (kPa)	Pressure (psi)
<b>Conversion to metres (m)</b>	Height (m) = ____ kPa x 0.10	Height (m) = ____ psi x 0.70
<b>Conversion to feet (ft.)</b>	Height (ft.) = ____ kPa x 0.33	Height (ft.) = ____ psi x 2.31

b. Total dynamic head (m or ft.) = Static lift + Static height + Friction loss

**Where:** *Static lift is the height from the water level to the pump (applicable only for jet pumps). Static height is the height from the pump to the furthest fixture. Friction loss can be calculated using the method provided below.*

## Calculation of friction loss

### I. To calculate the Friction loss component of the Total dynamic head:

- a. calculate the friction head losses that occur due to the flow rate and pipe sizes using table C-5 (table values assume a SCH40 PVC pipe or similar material such as [PE] polyethylene or [PP] polypropylene is utilized):

**Table C-5** Friction head losses for SCH40 PVC pipe at various flow rates<sup>39</sup>

F <sub>100</sub> , Friction head (m / 100 m pipe)						
Flow rate, Q (LPM)	Pipe diameter					
	13 mm [½ in.]	18 mm [¾ in.]	25 mm [1 in.]	32 mm [1 ¼ in.]	38 mm [1 ½ in.]	50 mm [2 in.]
<b>8</b>	4.8	1.2	0.38	0.1		
<b>19</b>	25.8	6.3	1.9	0.5	0.2	
<b>30</b>	63.7	15.2	4.6	1.2	0.6	0.2
<b>38</b>	97.5	26	6.9	1.8	0.8	0.3
<b>57</b>		49.7	14.6	3.8	1.7	0.5
<b>76</b>		86.9	25.1	6.4	2.9	0.9
<b>113</b>				13.6	6.3	1.8

### ■ Example

Using table C-5, for a pump generating a flow rate of 38 LPM [10 GPM], with a rainwater service pipe diameter of 32 mm [1 ¼ in.] and a rainwater supply pipe diameter of 18 mm [¾ in.]:

**F<sub>100-SE</sub>, Friction head (m / 100 m pipe) = 1.8 m / 100 m pipe-service pipe**

**F<sub>100-SU</sub>, Friction head (m / 100 m pipe) = 26 m / 100 m of pipe-supply pipe**

<sup>39</sup> Adapted from Residential Water Systems: Goulds Pumps Technical Data, Water Products, 2007. ITT Corporation, White Plains, N.Y.

- b. Calculate the friction head losses that occur due to the type of pipe fitting and pipe size using table C-6 (table values assume a SCH40 PVC pipe or similar material such as [PE] polyethylene or [PP] polypropylene is utilized)

**Table C-6** Equivalent length of pipe for different fittings<sup>40</sup>

Equivalent length of pipe (m)							
Fitting	Pipe diameter						
	13 mm [½ in.]	18 mm [¾ in.]	25 mm [1 in.]	32 mm [1 ¼ in.]	38 mm [1 ½ in.]	50 mm [2 in.]	75 mm [3 in.]
<b>90° elbow</b>	0.5	0.6	0.8	1.1	1.3	1.7	2.4
<b>45° elbow</b>	0.2	0.3	0.4	0.5	0.6	0.8	1.2
<b>Gate valve (shut-off valve) (open)</b>	0.1	0.2	0.2	0.2	0.3	0.4	0.5
<b>Tee flow – run</b>	0.3	0.6	0.6	0.9	0.9	1.2	1.8
<b>Tee flow – branch</b>	1.0	1.4	1.7	2.3	2.7	3.7	5.2
<b>In line check valve (Spring) or foot valve</b>	1.2	1.8	2.4	3.7	4.3	5.8	9.8

■ **Example**

Using table C-6, for a pressure system with three 32-mm [1-¼ in.], 90° elbows on the rainwater service piping, and five 18-mm [¾-in.], 90° elbows on the rainwater supply piping:

**$L_{F-SE}$ , Equivalent length of pipe (m) = 3 x 1.1**

**$L_{F-SE}$ , Equivalent length of pipe (m) = 3.3 m service pipe**

**$L_{F-SU}$ , Equivalent length of pipe (m) = 5 x 0.6**

**$L_{F-SU}$ , Equivalent length of pipe (m) = 3.0 m supply pipe**

- c. To calculate the total friction head losses, equation C-1 should be used:

$$Friction\ loss = (L_{P-SE} + L_{F-SE}) \times \frac{F_{100-SE}}{100\ m\ pipe} + (L_{P-SU} + L_{F-SU}) \times \frac{F_{100-SU}}{100\ m\ pipe} \quad \text{Equation C-1}$$

<sup>40</sup> Adapted from Residential Water Systems: Goulds Pumps Technical Data, Water Products. 2007. ITT Corporation, White Plains, N.Y.

**Where:** *Friction loss* = Combined friction losses (m) for the service piping (SE) and supply piping (SU)

$L_p$  = Linear length of pipe (m)

$L_F$  = Equivalent length of the pipe fittings (m)

$F_{100}$  = Friction loss per 100 m of pipe

#### ■ Example

Using the above equation, the losses for a pump and pressure system using the above pipe diameters and number of fittings, where the length of the rainwater service piping was 15 m and the rainwater supply piping was 10 m:

$$\text{Friction loss} = \left[ (15 \text{ m} + 3.3 \text{ m}) \times \frac{1.8 \text{ m}}{100 \text{ m pipe}} \right] + \left[ (10 \text{ m} + 3 \text{ m}) \times \frac{26 \text{ m}}{100 \text{ m pipe}} \right]$$

$$\text{Friction loss} = [0.33 \text{ m}] + [3.38 \text{ m}]$$

$$\text{Friction loss} = 3.7 \text{ m} [12.2 \text{ ft.}]$$

For the pump and pressure system described above, the friction loss is equivalent to 3.7 m of pipe, which can be used to calculate the Total dynamic head.

### Calculation of pressure tank size

#### I. To size a pressure tank that is compatible with a constant speed pump:

- a. Use the following equation to calculate the required capacity for the pressure tank:

$$\text{Tank size (L)} = 3.78 \times \left( \frac{\text{Pump flow rate (GPM)} \times \text{Pump run time (min)}}{\text{Drawdown factor}} \right)$$

Equation C-2

**Where:** *Pump flow rate (capacity) was determined above.*

*Pump run time is provided by the pump manufacturer/supplier (typically, 1-2 minutes). The drawdown factor can be determined using table C-7*

**Table C-7** Drawdown factors for various cut-in/cut-out pressures<sup>41</sup>

System pressure (Cut-in/cut-out pressure)	Drawdown factor
138/276 kPa [20/40 psi]	0.37
276/414 kPa [40/60 psi]	0.27
414/552 kPa [60/80 psi]	0.21
552/689 kPa [80/100 psi]	0.17

<sup>41</sup> Adapted from Residential Water Systems: Goulds Pumps Technical Data, Water Products, 2007. ITT Corporation, White Plains, N.Y.

## Calculation of pipe size

I. To determine the required pipe size diameter for the rainwater service piping and supply piping, the following steps can be used for estimation purposes:

a. For the service piping

- i. The diameter of the rainwater service pipe can be sized using the equation below (the equation assumes PVC or similar material such as [PE] polyethylene or [PP] polypropylene is utilized):

$$\text{Pipe diameter (mm)} = 25.4 \times \left( \frac{0.098 \times \frac{Q^{1.85}}{3.78}}{F_{100-SE}} \right)^{\frac{1}{4.87}}$$

Equation C-3<sup>42</sup>

**Where:**  $Q$  = the pump flow rate (LPM)

$F_{100}$  = the friction loss per 100 m of pipe (see following steps for details)

- ii. Before this equation can be solved, however, the maximum permitted head loss ( $F_{100-SE}$ ) must be set. A general rule of thumb is that this loss not exceed 5 m/100 m pipe [5 ft./100 ft. pipe]<sup>43</sup>; however, the pump manufacturer/supplier should be contacted to confirm that these head losses will not impair pump performance or cause a loss of prime.

iii. **Example:**

Assuming that  $F_{100-SE} = 5$  m/100 m of pipe, the pipe diameter can be calculated as follows for a 38 LPM [10 GPM] pump:

$$\text{Pipe diameter (mm)} = 25.4 \times \left( \frac{0.098 \times \left( \frac{38}{3.78} \right)^{1.85}}{5} \right)^{\frac{1}{4.87}}$$

$$\text{Pipe diameter (mm)} = 27.2$$

$$\text{Pipe diameter (mm)} = 32 \text{ mm [1 } \frac{1}{4} \text{ in.]}$$

b. For the supply piping

- i. Rainwater supply pipe must be sized in accordance with applicable provincial/territorial codes and regulations. The following information is provided for estimation purposes only.
- ii. To size the rainwater supply pipe for private use (such as a single-detached household), refer to table C-8 and instructions on next page.

<sup>42</sup> Adapted from Hazen-Williams Equation - Calculating Friction Head Loss in Water Pipes. 2005. The Engineering ToolBox.

<sup>43</sup> Planning for an Individual Water System. Fourth Edition Revised. 1982. Turner, H.J., Athens, Ga.

**Table C-8** Supply pipe sizing for various fixtures<sup>44</sup>

Fixture	Minimum size of supply pipe	Hydraulic load (fixture units)
<b>Toilet, 6 LPF or less with flush tank</b>	10 mm [ $\frac{3}{8}$ in.]	2.2
<b>Toilet, greater than 6 LPF with flush tank</b>	10 mm [ $\frac{3}{8}$ in.]	3
<b>Urinal, with flush tank</b>	10 mm [ $\frac{3}{8}$ in.]	3
<b>Urinal, with self-closing metering valve</b>	13 mm [ $\frac{1}{2}$ in.]	2
<b>Hose bib</b>	13 mm [ $\frac{1}{2}$ in.]	2.5
<b>Hose bib</b>	18 mm [ $\frac{3}{4}$ in.]	3
<b>Washing machine, 3.5 kg [front load]</b>	13 mm [ $\frac{1}{2}$ in.]	2.25
<b>Washing machine, 6.8 kg [top-down]</b>	13 mm [ $\frac{1}{2}$ in.]	3
<b>Lavatory, 8.3 LPM or less</b>	10 mm [ $\frac{3}{8}$ in.]	0.7
<b>Lavatory, greater than 8.3 LPM</b>	10 mm [ $\frac{3}{8}$ in.]	1
<b>Bathtub (with or without shower)</b>	13 mm [ $\frac{1}{2}$ in.]	1.4

- iii. In table C-8, the minimum diameter of pipe that can be used to supply an individual residential plumbing fixture is listed in the second column (for toilets, the minimum size of supply pipe permitted is 10 mm [ $\frac{3}{8}$  in.]).
- iv. The values in the third column, hydraulic load (fixture units), are used to determine the pipe diameter of the piping immediately following the pressure tank/control unit. This represents the diameter of the main branch from which smaller supply pipes will be run to individual fixtures.
- v. The hydraulic load of the pump and pressure system is calculated by summing up the number of fixture units based upon the types and number of fixtures connected to the system.

■ **Example<sup>45</sup>**

If three 6 LPF toilets and one front-loading (3.5 kg) washing machine are connected to the system, the hydraulic load can be calculated as follows:

$$\text{Hydraulic load (fixture units)} = (3 \times 2.2) + (1 \times 2.25)$$

$$\text{Hydraulic load (fixture units)} = 8.85 \text{ fixture units}$$

- vi. Once the number of fixture units have been determined, the required size of rainwater supply pipe can be determined using table C-9.

<sup>44</sup> Adapted from *National Plumbing Code of Canada*. 2010. National Research Council of Canada, Ottawa, ON.

<sup>45</sup> Note: Example utilizes hydraulic load figures from the 2010 *National Plumbing Code*. Consult the appropriate code when sizing piping.



**Table C-9** Maximum allowable pipe lengths<sup>46</sup>

Pipe diameter	Maximum allowable length (m)			
	12	18	24	30
	Number of fixture units served			
<b>13 mm [½ in.]</b>	6	5	4	3
<b>18 mm [¾ in.]</b>	18	16	14	12
<b>25 mm [1 in.]</b>	36	31	27	25
<b>32 mm [1 ¼ in.]</b>	83	68	57	48
<b>38 mm [1 ½ in.]</b>	151	124	105	91

■ **Example**

Referring to table C-9, if the total length of the supply pipe is 17 m, and the hydraulic load is equal to 8.85 (~9) fixture units:

***Pipe diameter*** = 18 mm [¾ in.]

*Note: With the example above, ¾ in. pipe must be used since 17 m > 12 m, so the 18 m column must be referenced, following which 9 fixture units > 5 fixture units (making ½ in. pipe insufficient), therefore ¾ in. pipe must be used, as 9 fixture units < 16 fixture units.*

<sup>46</sup> Adapted from National Plumbing Code of Canada. 2010. National Research Council of Canada, Ottawa, ON.

## Appendix D OVERFLOW PROVISIONS AND STORMWATER MANAGEMENT

### Using a rainwater storage tank for retention and detention for stormwater management purposes

- I. To design a rainwater harvesting system for the purpose of extended detention and controlled release of stormwater, the following schematic (figure D-1) and guidelines are provided for estimation purposes only:

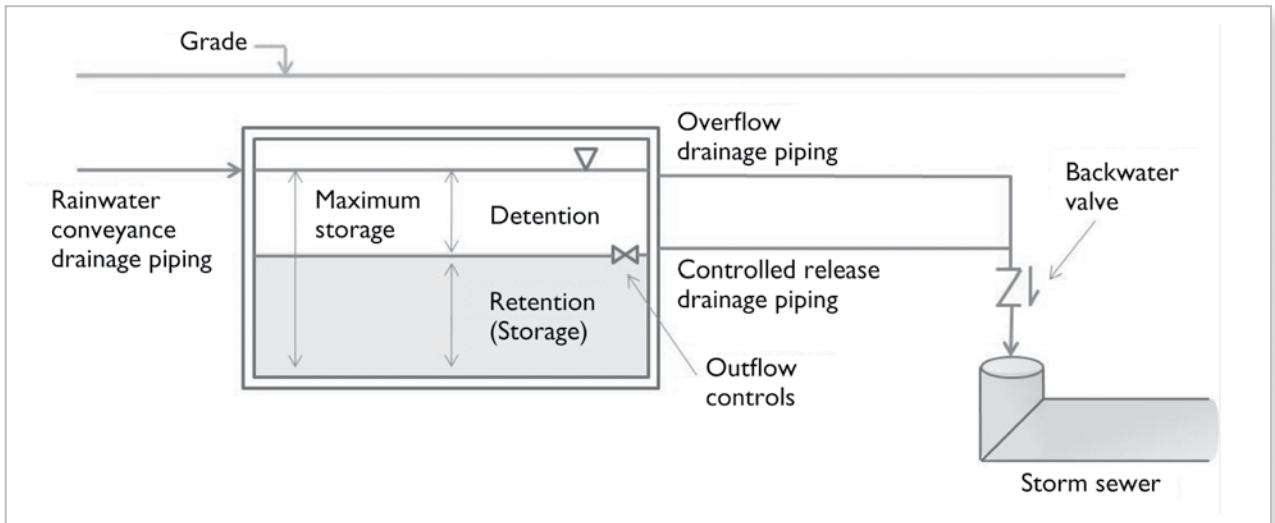

**Figure D-1** RWHS system with outflow controls and controlled release drainage piping for stormwater management. ('DETENTION' is the volume of runoff to be slowly released to storm sewer. The remaining volume 'RETENTION' is used to supply rainwater to permitted fixtures.)

- a. To size the retention (storage) volume:
  - i. refer to *Appendix B* for guidelines regarding the sizing of rainwater storage tanks. The storage tank volume determined using the methods provided in *Appendix B* shall be the retention volume of the rainwater tank.
- b. To size the detention volume:
  - i. *Note: While a rainwater tank can be used to provide extended detention for stormwater management purposes, the required storage volumes may be very large for large roof areas.*
  - ii. contact the local conservation authority and/or municipality regarding the size of rainfall event or volume of stormwater to be detained in the tank for the particular site.

■ **Example**

If a municipality requires that 5 mm of rainfall must be detained, then for a roof with a 200-m<sup>2</sup> catchment area:

$$\text{Detention volume (L)} = \text{Rainfall event (mm)} \times \text{Area (m}^2\text{)}$$

Equation D-1

$$\text{Detention volume (L)} = 5 \text{ mm} \times 200 \text{ m}^2$$

$$\text{Detention volume (L)} = 1,000 \text{ L}$$

- c. Given the detention volume, the maximum storage depth can be calculated by:

$$H = \frac{V}{w \times l}$$

Equation D-2<sup>47</sup>

**Where:** *H* = Maximum storage depth, measured from the bottom of the overflow drainage pipe to the centreline of the drawdown pipe (m)

*V* = Stormwater detention volume (m<sup>3</sup>)

*w* = Width of the rainwater storage tank (m)

*l* = Length of the rainwater storage tank (m)

- d. Next, the rate of discharge from the controlled release pipe can be determined as follows:

$$Q = Q_{AVG} \times F$$

Equation D-3<sup>48</sup>

**Where:** *Q* = Peak discharge rate (m<sup>3</sup>/s)

*Q*<sub>AVG</sub> = Average discharge rate (discharge volume/drawdown time) (m<sup>3</sup>/s)

*F* = Peaking factor (typically 1.5)

- e. Finally, to size the diameter of the controlled release pipe:

$$D^2 = \frac{4Q}{C_d \pi \sqrt{2gH}}$$

Equation D-4<sup>49</sup>

**Where:** *D* = Required controlled release pipe diameter (m)

*Q* = Peak discharge rate (m<sup>3</sup>/s)

*C*<sub>d</sub> = Coefficient depending on the type of orifice (available in engineering texts or manuals)

*g* = Acceleration due to gravity (9.8 m/s<sup>2</sup>)

*H* = Maximum storage depth, measured from the bottom of the overflow drainage pipe to the centreline of the drawdown pipe (m)

#### ■ Example

For a rainwater harvesting system with the characteristics listed in table D-1, a rainwater harvesting system for detention and controlled release can be sized as follows:

<sup>47</sup> Adapted from Low Impact Development Stormwater Management Manual (Draft). 2008. Toronto and Region Conservation Authority, Toronto, ON.

<sup>48</sup> Low Impact Development Stormwater Management Manual (Draft). 2008. Toronto and Region Conservation Authority, Toronto, ON.

<sup>49</sup> Adapted from Stormwater Management Planning and Design Manual. 2003. Ontario Ministry of the Environment, Toronto, ON.

**Table D-1** RWH system characteristics (example)

Detail	Value
Storage tank volume	18 m <sup>3</sup>
Maximum stormwater detention volume	9 m <sup>3</sup>
Storage tank dimensions (l x w x h)	6.2 m x 2.6 m x 1.3 m

$$H = \frac{V}{w \times l}$$

$$H = \frac{9 \text{ m}^3}{6.2 \text{ m} \times 2.6 \text{ m}}$$

$$H = 0.56 \text{ m}$$

$$\mathbf{H \approx 0.6 \text{ m}}$$

Given this height, the centerline (middle) of the controlled release pipe would need to be installed at a height 0.6 m below the bottom of the overflow drainage pipe

The peak discharge from the rainwater storage tank, over a 24-hour period would be:

$$Q_{AVG} = \frac{9 \text{ m}^3}{24 \text{ hr} \times 60 \frac{\text{min}}{\text{hr}} \times 60 \frac{\text{s}}{\text{min}}}$$

$$Q_{AVG} = 0.000104 \text{ m}^3/\text{s}$$

$$Q = Q_{AVG} \times F$$

$$Q = 0.000104 \frac{\text{m}^3}{\text{s}} \times 1.5$$

$$\mathbf{Q = 0.000156 \text{ m}^3/\text{s}}$$

Assuming the depth in the cistern is 0.56 m when the full 9 m<sup>3</sup> is being stored, the required pipe size would be:

$$D^2 = \frac{4 Q}{C_d \pi \sqrt{2gH}}$$

$$D = \frac{4 \times 0.000156}{0.62 \pi \sqrt{2 \times 9.8 \times 0.56}}$$

$$D = 0.0098 \text{ m}$$

$$D \approx 10 \text{ mm}$$

Thus, based on these calculations, a 10-mm diameter pipe is required; however, in practice, such a small orifice would not be used as it would be prone to clogging or to freezing during the winter. A minimum orifice size recommended for controlled release pipes is 75 mm.<sup>50</sup> Consult the local conservation authority and/or municipality regarding the minimum controlled release pipe diameter sizing.

### Design and sizing of soakaway pits

Soakaway pits are composed of an excavated space filled with a non-porous material, surrounded by an outer filter fabric. A basic infiltration trench, suitable for most RWH systems, is illustrated below in figure D-2.

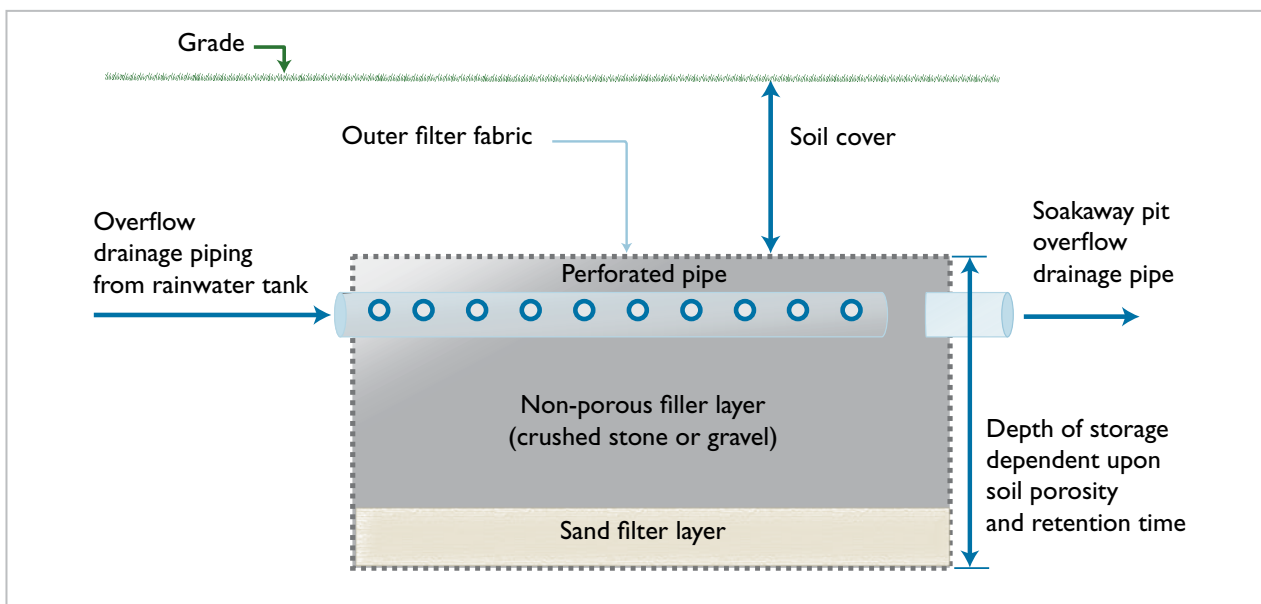

**Figure D-2** A typical soakaway pit (cross-section view)<sup>51</sup>

<sup>50</sup> Low Impact Development Stormwater Management Manual (Draft). 2008. Toronto and Region Conservation Authority, Toronto, ON. 75 mm is the minimum orifice size required for controlled release pipes in stormwater retention ponds located in the City of Toronto.

<sup>51</sup> Adapted from Stormwater Management Planning and Design Manual. 2003. Ontario Ministry of the Environment, Toronto, ON.

The materials required for a soakaway pit include:

- **storage media** – crushed stone of a uniform size, used to provide a non-porous structure for the pit;
- **outer fabric** – non-woven filter fabric (polypropylene geotextile), used to protect the storage media from becoming clogged by the surrounding soil;
- **distribution pipes** – perforated drainage pipe used to distribute rainwater uniformly throughout the entire pit/trench; and
- **filter layer** – fine sand placed on the outer fabric on the bottom of the trench to filter impurities prior to infiltration.

#### 1. General design considerations<sup>52</sup>

- a. The soakaway pit should be located at least 4 m [13 ft.] away from a building foundation or other buried structure, and 1.5 m [5 ft.] from buried water or utility lines.
- b. The length of the pit (parallel to the overflow drainage pipe) should be maximized compared to the width.
- c. The maximum height of the pit/trench should be 1.5 m [5 ft.].
- d. The soakaway pit should be buried sufficiently to protect it from freezing.

#### 2. To size a soakaway pit or infiltration trench, the following guidelines are provided for estimation purposes only<sup>53</sup>

- a. The depth of the soakaway pit can be calculated using equation D-5 (further details below):

$$d = \frac{P \times T}{1,000}$$

Equation D-5

**Where:** *d* = Maximum allowable depth of the soakaway pit (m)

*P* = Percolation rate (mm/hour)

*T* = Drawdown time (hour)

- b. Given the storage depth, the size (area) of the soakaway pit can then be calculated using equation D-6:

$$A = \frac{V}{d \times n}$$

Equation D-6

**Where:** *A* = Surface area of soakaway pit (m<sup>2</sup>)

*V* = Runoff volume to be infiltrated (m<sup>3</sup>)

*d* = Maximum allowable depth of the soakaway pit (m)

*n* = Porosity of storage media (0.4 for clear stone)

<sup>52</sup>Adapted from Stormwater Management Planning and Design Manual. 2003. Ontario Ministry of the Environment, Toronto, ON, and Low Impact Development Stormwater Management Manual (Draft). 2008. Toronto and Region Conservation Authority, Toronto, ON.

<sup>53</sup>Adapted from Stormwater Management Planning and Design Manual. 2003. Ontario Ministry of the Environment, Toronto, ON.

- c. When calculating equation D-5 and equation D-6, the following sizing guidelines are recommended.
  - i. Soakaway pits can only be used in areas where soil has a percolation rate  $\geq 15$  mm/hr. Refer to table D-2 for approximate percolation rates for various soils. *Note: to ensure that soil has the necessary infiltration capacity, soil may need to be tested.*

**Table D-2** Minimum soil percolation rates<sup>54</sup>

Soil type	Percolation rate “P” (mm/hr)
<b>Sand</b>	210
<b>Loamy sand</b>	60
<b>Sandy loam</b>	25
<b>Loam</b>	15

- ii. A conservative drawdown time of 24 hr ( $T = 24$  hr) should be chosen when calculating the depth of the soakaway pit/infiltration trench.
- iii. The maximum depth (d) of the soakaway pit should be no more than 1.5 m to maximize the infiltration capacity of the pit/trench. If the calculated depth is  $> 1.5$ , use 1.5.
- iv. The surface area of the trench should be configured in a 4:1 ratio for length to width to ensure the full bottom area of the trench is being used for infiltration.
- v. A maximum storage volume equal to the runoff from a 4-hour, 15 mm/h storm is recommended:

$$V = \frac{\text{Catchment area (m}^2) \times 15 \frac{\text{mm}}{\text{hr}} \times 4 \text{ hr}}{1,000}$$

Equation D-7

■ **Example**

For a rainwater harvesting system with the characteristics listed in table D-3, a soakaway pit can be sized as follows:

**Table D-3** RWH system characteristics (example)

Detail	Value
<b>Catchment area (A)</b>	150 m <sup>2</sup>
<b>Soil percolation rate (P)</b>	60 mm/hr
<b>Storage media porosity (d)</b>	0.4 clear stone

<sup>54</sup> Adapted from Stormwater Management Planning and Design Manual, 2003. Ontario Ministry of the Environment, Toronto, ON.

$$d = \frac{P \times T}{1,000}$$

$$d = \frac{60 \frac{mm}{hr} \times 24 \text{ hr}}{1,000}$$

$$\mathbf{d = 1.44 \text{ m}}$$

Given the depth of the soakaway pit, the size (area) of the pit/trench can be calculated as follows:

$$V = \frac{\text{Catchment area (m}^2\text{)} \times 15 \frac{mm}{hr} \times 4 \text{ hr}}{1,000}$$

$$V = \frac{150 \text{ m}^2 \times 15 \frac{mm}{hr} \times 4 \text{ hr}}{1,000}$$

$$\mathbf{V = 9 \text{ m}^3}$$

$$A = \frac{V}{d \times n}$$

$$A = \frac{9 \text{ m}^3}{1.44 \text{ m} \times 0.4}$$

$$\mathbf{A = 15.6 \text{ m}^2}$$

Given this example, to infiltrate the rainwater on site, given the design criteria of the rainwater harvesting system and the surrounding soils, the soakaway pit would need to be 1.4 m deep, with an area of 16 m<sup>2</sup>.



3. The soakaway pit must be buried at a sufficient depth to protect it from frost. figure D-3 indicates the required soil cover, based on soil type and depth of soakaway pit.

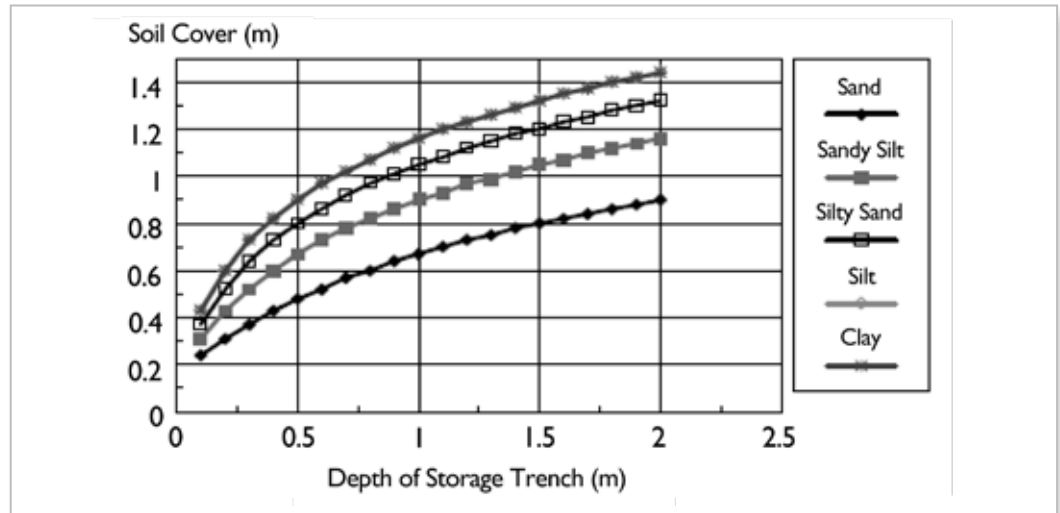

**Figure D-3** Soil cover for soakaway pits, based on frost heave<sup>55</sup>

<sup>55</sup> Stormwater Management Planning and Design Manual, 2003. Ontario Ministry of the Environment, Toronto, ON.

# Guidelines for Residential Rainwater Harvesting Systems Handbook