

Draft – 10-11-2023

**USER AGREEMENT FOR THE WORD COPY OF THE
ICC/NSSA Standard for the Design and Construction of Storm Shelters–2023 draft
(ICC 500–2023 draft)**

By downloading or otherwise using this WORD copy of the ICC/NSSA Standard for the Design and Construction of Storm Shelters–2023 draft (ICC 500–2023 draft) (the “File”), you hereby agree to: (i) not further distribute, display, or reproduce the File to anyone outside the committee (the “Committee”); (ii) take reasonable measures to maintain security of the File (including use of a password, if the File is password protected by ICC); (iii) to report promptly to ICC any infringement, misuse or other unauthorized use of the File that comes to your attention; and (iv) to delete the File and related drafts as requested by ICC. On the condition of your compliance with the foregoing requirements, ICC hereby grants you the limited license to use and modify the attached WORD copy of the File solely in connection with your responsibilities as a member of the Committee. ICC maintains all right, including copyright, in the File.

Use of this document constitutes your agreement to abide by the User Agreement located at the beginning of this document.

ICC/NSSA Standard for the Design and Construction of Storm Shelters—**2023 draft**
(ICC 500—**2023 draft**)

Copyright © **2023**
by
INTERNATIONAL CODE COUNCIL, INC.

ALL RIGHTS RESERVED. This ICC/NSSA *Standard for the Design and Construction of Storm Shelters—2023 draft* (ICC 500—**2023 draft**) is a copyrighted work owned by the International Code Council, Inc. (“ICC”). Without advance written permission from the ICC, no part of this book may be reproduced, distributed or transmitted in any form or by any means, including, without limitation, electronic, optical or mechanical means (by way of example, and not limitation, photocopying, or recording by or in an information storage retrieval system). For information on use rights and permissions, please contact: ICC Publications, 4051 Flossmoor Road, Country Club Hills, IL 60478. Phone 1-888-ICC-SAFE (422-7233).

Trademarks: “International Code Council,” the “International Code Council” logo, “ICC,” the “ICC” logo and other names and trademarks appearing in this book are registered trademarks of the International Code Council, Inc., and/or its licensors (as applicable), and may not be used without permission.

Cover Photo Credit:

Use of this document constitutes your agreement to abide by the User Agreement located at the beginning of this document.

American National Standard

Approval of an American National Standard requires verification by ANSI that the requirements for due process, consensus and other criteria for approval have been met by the standards developer.

Consensus is established when in the judgment of the ANSI Board of Standards Review, substantial agreement has been reached by directly and materially affected interests. Substantial agreement means much more than a simple majority, but not necessarily unanimity. Consensus requires that all views and objections be considered, and that a concerted effort be made toward their resolution.

The use of American National Standards is completely voluntary; their existence does not in any respect preclude anyone, whether he or she has approved the standards or not, from manufacturing, marketing, purchasing or using products, processes or procedures not conforming to the standards.

The American National Standards Institute does not develop standards and will in no circumstances give an interpretation of any American National Standard. Moreover, no person shall have the right or authority to issue an interpretation of an American National Standard in the name of the American National Standards Institute. Requests for interpretations should be addressed to the secretariat or sponsor whose name appears on the title page of this standard.

CAUTION NOTICE: This American National Standard may be revised or withdrawn at any time. The procedures of the American National Standards Institute require that action be taken periodically to reaffirm, revise or withdraw this standard. Purchasers of American National Standards may receive current information on all standards by calling or writing the American National Standards Institute.

FOREWORD

[The information contained in this foreword is not part of this American National Standard (ANS) and has not been processed in accordance with ANSI's requirements for an ANS. As such, this foreword may contain material that has not been subjected to public review or a consensus process. In addition, it does not contain requirements necessary for conformance to this standard.]

Introduction

IS-STM 03-02-23 AM/AFM BC2

In May of 2002 the International Code Council (ICC) and the National Storm Shelter Association (NSSA) initiated a joint project to write a standard for the design and construction of storm shelters. A standard development committee was created, and the first meeting of that committee was in May of 2003. The scope of the standard is to provide minimum design and construction requirements for storm shelters that provide a safe refuge from storms that produce high winds, hurricanes and tornadoes. Hurricanes and tornadoes generate high winds that produce wind pressures on buildings and structures and that create flying debris at levels and intensities that are higher than those for which most commercial buildings and residences are designed. The magnitude of the ~~tornado and~~ wind speeds associated with these storms are such that building occupants and residents are required to evacuate the area or seek protection in a shelter designed for resistance to extraordinary loads and flying debris. This standard provides design requirements for the main wind force resisting structural system and components and cladding of these shelters, and provides basic occupant life safety and health requirements for these shelters, including means of egress, lighting, sanitation, ventilation, fire safety and minimum required floor space for occupants.

Development

This is the third edition of the International Code Council (ICC) and National Storm Shelter Association's (NSSA) *Standard for the Design and Construction of Storm Shelters*. This standard was developed by the ICC/NSSA Consensus Committee on Storm Shelters (IS-STM) that operates under ANSI Approved ICC Consensus Procedures for the Development of ICC Standards. The consensus process of ICC for promulgating standards is accredited by ANSI. The Storm Shelter Committee is a balanced committee formed and operated in accordance with ICC rules and procedures.

The meetings of the ICC/NSSA IS-STM Consensus Committee were open to the public and interested individuals and organizations from across the country participated. The technical content of currently published documents on storm shelters, including documents of the National Storm Shelter Association, the Federal Emergency Management Agency (FEMA), the Red Cross, and the State of Florida, was reviewed and considered by the committee. The information from these documents helped form a basis for the regulations installed in this standard, but the exact provisions adopted by the committee were determined based upon the scope and intent of this standard. The requirements of ICC/NSSA 500 are based on the intent to establish provisions consistent with the scope of the ICC family of codes and standards that are written to adequately protect public health, safety and welfare; provisions that do not necessarily increase construction costs; provisions that do not restrict the use of new materials, products or methods of construction; and

Use of this document constitutes your agreement to abide by the User Agreement located at the beginning of this document.

provisions that do not give preferential treatment to particular types or classes of materials, products or methods of construction.

Adoption

ICC/NSSA 500 *Standard for the Design and Construction of Storm Shelters* is available for adoption and use by any jurisdiction. Its use within a governmental jurisdiction is intended to be accomplished through adoption by reference in accordance with proceedings establishing the jurisdiction's laws. At the time of adoption, jurisdictions should insert the appropriate information in provisions requiring specific local information, such as the name of the jurisdiction.

Interpretations

Requests for Interpretations on the provisions of ICC 500—~~2020~~ **2023** should be addressed to: ICC, Central Regional Office, 4051 Flossmoor Road, Country Club Hills, IL 60478.

Maintenance – Submittal of Proposals

All ICC standards are periodically updated as required by ANSI. Proposals for revising this edition are welcome. Please visit the ICC website at www.iccsafe.org for the official “Call for Proposals” announcement. A proposal form and instructions can also be downloaded from www.iccsafe.org.

This standard is maintained under a continuous maintenance schedule to consider recommended changes to any part of it by action of the consensus body. The Code Council accepts public comments and proposals for this standard on a continual basis and during regular calls for comment. Comments and proposals submitted on ICC Public Comment and Proposal Forms may be submitted to the committee secretariat at kpaarlberg@iccsafe.org.

ICC, its members and those participating in the development of ICC 500—~~2020~~ **2023** do not accept any liability resulting from compliance or noncompliance with the provisions of ICC 500—~~2020~~ **2023**. ICC does not have the power or authority to police or enforce compliance with the contents of this standard. Only the governmental body that enacts this standard into law has such authority.

International Code Council/National Storm Shelter Association Consensus Committee on Storm Shelters (IS-STM)

Consensus Committee SCOPE: The ICC/NSSA Consensus Committee on Storm Shelters (IS-STM) shall have primary responsibility for minimum requirements to safeguard the public health, safety and general welfare through design, construction and installation requirements for storm shelters.

This standard was processed and approved for submittal to ANSI by the ICC/NSSA Consensus Committee on Storm Shelters (IS-STM). Committee approval of the standard does not necessarily imply that all committee members voted for its approval.

Representatives on the Consensus Committee are classified in one of three voting interest categories. The committee has been formed in order to achieve consensus as required by ANSI Essential Requirements. At the time it approved this standard, the IS-STM Consensus Committee consisted of the following members:

~~General Interest (G) – User Interest (U) – Producer Interest (P)~~

Use of this document constitutes your agreement to abide by the User Agreement located at the beginning of this document.

Manufacturer(A); Builder(B); Standards Promulgator/Testing Laboratory(C); User(D); Utility(E); Consumer(F); Public Segment(G); Government Regulator(H); Insurance(I).

Mr. Brian Bishop, CBO (GH), City of Des Moines, IA

Mr. Gary J. Ehrlich, P.E. (BP), National Association of Home Builders , Washington, DC

Mr. Benchmark Harris, P.E. (A), National Storm Shelter Association, Fort Worth, TX

Mr. Rick Hautekeete, P.E. (D), McClure Engineering, St. Louis, MO

Dr. Andrew Holstein, Ph.D., PE (C), Intertek, Middleton, WI

Mr. John T. Hutton, P.E., S.E. (UD), NCSEA Code Advisory Committee, Atlanta, GA

~~Mr. Danny John Kilcollins (G), Florida Division of Emergency Management, Tallahassee, FL~~

~~Mr. Scott Lambaise, CBO (G), MA Building Commissioners and Inspectors, Duxbury, MA~~

Dr. Marc L. Levitan (UC), National Institute of Standards and Technology, Gaithersburg, MD

Mr. Andie Lorenz, CBO (GH), Adams County, Othello, WA

~~Ms. Bonnie Manly, P.E. (P) American Iron and Steel Institute, Norfolk, MA-~~

~~Mr. Kurt A. Roeper (P), ASSA ABLOY Americas Door Security Solutions, New Haven, CT~~

~~Dr.-Ms. Pataya Scott Ph.D., EIT (GD), FEMA, Washington, DC~~

Mr. Corey Schultz, AIA (UD), Schultz Squared Architects, LLC, Wichita, KS

Mr. David Stammen, (A) ASSA ABLOY, New Haven, CT

Mr. Steve Szoke, P.E. (UC), American Concrete Institute, Antioch, IL

Mr. Paul Taft (GH), ~~Town of North Salem, NY~~ Village of Bronxville, NY

Mr. E. Scott Tezak, P.E. (UD), Atkins, ~~Boston, MA~~ Alexandria, VA

Mr. Anthony L. Warren, CBO, CFM (H), City of Waxahachie, Waxahachie, TX

Dr. Borjen Yeh, Ph.D., P.E. (PC), APA-The Engineered Wood Association, Tacoma, WA

Committee Secretariat **Kimberly Paarlberg, RA**, Senior Staff Architect, Codes and Standards, International Code Council, Country Club Hills, IL

Voting Membership in Each Category

Category	Number
General (G)	5
User (U)	6
Producer (P)	4
<u>Manufac- turer(A)</u>	<u>2</u>
<u>Builder(B)</u>	<u>1</u>

Use of this document constitutes your agreement to abide by the User Agreement located at the beginning of this document.

<u>Standards Promulgator/Testing Laboratory(C)</u>	<u>4</u>
<u>User(D)</u>	<u>5</u>
<u>Utility(E)</u>	<u>0</u>
<u>Consumer(F)</u>	<u>0</u>
<u>Public Segment(G)</u>	<u>0</u>
<u>Government Regulator(H)</u>	<u>4</u>
<u>Insurance(I)</u>	<u>0</u>
TOTAL	<u>15-16</u>

Interest Categories

~~General Interest: Individuals assigned to the General Interest category are those who represent the interests of an entity, including an association of such entities, representing the general public or entities that promulgate or enforce the provisions within the committee scope. These entities include consumers and government regulatory agencies.~~

~~User Interest: Individuals assigned to the User Interest category are those who represent the interests of an entity, including an association of such entities, which is subject to the provisions or voluntarily utilizes provisions within the committee scope. These entities include academia, applied research laboratory, building owner, design professional, government nonregulatory agency, insurance company, private inspection agency and product certification/evaluation agency.~~

~~Producer Interest: Individuals assigned to the Producer Interest category are those who represent the interests of an entity, including an association of such entities, which produces, installs or maintains a product, assembly or system subject to the provisions within the committee scope. These entities include builder, contractor, distributor, labor, manufacturer, material association, standards promulgator, testing laboratory and utility.~~

~~**Manufacturer(A):** Individuals assigned to the Manufacturer Interest category are those who represent the interests of an entity, including an association of such entities that produces an assembly or system subject to the provisions within the committee scope.~~

~~**Builder(B):** Individuals assigned to the Builder Interest category are those who represent the interests of an entity, including an association of such entities that builds, installs or maintains an assembly or system subject to the provisions within the committee scope.~~

~~**Standards Promulgator/Testing Laboratory(C):** Individuals assigned to the Standards Promulgator/Testing Laboratory Interest category are those who represent the interests of an entity, including an association of such entities that provides independent standards promulgation or laboratory testing of an assembly or system subject to the provisions within the committee scope.~~

~~Use of this document constitutes your agreement to abide by the User Agreement located at the beginning of this document.~~

User(D): Individuals assigned to the User Interest category are those who represent the interests of an entity, including an association of such entities, which is subject to the provisions or voluntarily utilize the provisions within the committee scope, including designers, architects, consultants and building owners.

Utility(E): Individuals assigned to the Utility category are those who represent the interests of an entity, including an association of such entities, which supplies power or water or accepts wastewater from an assembly or system subject to the provisions within the committee scope.

Consumer(F): Individuals assigned to the Consumer Interest category are those who represent the interests of an entity, including an association of such entities that represent the ultimate purchaser of the assembly or system subject to the provisions within the committee scope.

Public Segment(G): Individuals assigned to the Public Segment Interest category are those who represent the interests of an entity, including an association of such entities that represent a particular group of the public that benefits from the assembly or system subject to the provisions within the committee scope.

Government Regulator(H): Individuals assigned to the Government Regulator Interest category are those who represent the interests of an entity, including an association of such entities, representing the entities that promulgate or enforce the provisions within the committee scope.

Insurance(I): Individuals assigned to the Insurance Interest category are those who represent the interests of an entity, including an association of such entities, that insure subject to the provisions or voluntarily utilize the provisions within the committee scope, including insurance related inspection agencies.

~~NOTE — Multiple Interests:~~ ~~Individuals representing entities in more than one of the above interest categories, one of which is a Producer Interest, are assigned to the Producer Interest. Individuals representing entities in the General Interest and User Interest categories are assigned to the User Interest.~~

TABLE OF CONTENTS

CHAPTER 1 APPLICATION AND ADMINISTRATION

Section		
101	General	1
102	Compliance Alternatives	1
103	Conventions	1
104	Construction and Occupancy	1
105	Applicable Code	1
106	Submittal Documents	1
107	Quality Assurance Plan	3
108 109	Owner's Responsibility	3
109 108	Peer Review	4
110	<u>CONTRACTOR'S STATEMENT OF RESPONSIBILITY</u>	
110 111	Special Inspections	4
111 112	Structural Observations	4
112	Listing and Labeling	5
113	Evaluation, Maintenance and Repairs	5

CHAPTER 2 DEFINITIONS

Section		
201	General	7
202	Definitions	7
203	Symbols and Nomenclature	9

CHAPTER 3 STRUCTURAL DESIGN AND TESTING CRITERIA

Section		
301	General	11
302	Load Combinations	11
303	Loads	11
304	<u>TORNADO LOADS AND</u> Wind Loads	12
305	Debris Hazards	12
306	Storm Shelter Envelope Component Design and Testing	14
307	Connection of Storm Shelters to Foundations or Slabs	15

CHAPTER 4 SITING

Section		
401	General	27
402	Flood Criteria	27
403	Maximum Travel Distance for Tornado Shelters	28

CHAPTER 5
**OCCUPANCY OCCUPANT DENSITY, ACCESS ENTRY, ACCESSIBILITY, EGRESS AND
SIGNAGE**

Section		
501	General	29
502	Occupant Density in Community Storm Shelters	29
503	Occupant Density in Residential Storm Shelters	29
504	<u>ACCESS ENTRY</u> and Egress in Community Shelters	30
505	<u>ACCESS ENTRY</u> and Egress in Residential Storm Shelters	30
506	Vertical Access and Egress	31
507	Latching	32
508	Signage	32

CHAPTER 6
FIRE SAFETY

Section		
601	General	33
602	Fire Protection Systems	33
603	Fire- <u>Resistant Resistance</u> -Rated Construction	33
604	Fire Extinguishers	33

CHAPTER 7
STORM SHELTER ESSENTIAL FEATURES AND ACCESSORIES

Section		
701	General	35
702	Tornado Shelters	35
703	Hurricane Shelters	36

CHAPTER 8
TEST METHODS FOR IMPACT AND PRESSURE TESTING

Section		
801	General	39
802	Test Specimens	39
803	Impact Testing	39
804	Static and Cyclic Pressure Testing	48
805	Static and Cyclic Pressure Testing Procedures	48

CHAPTER 9
REFERENCED STANDARDS

APPENDIX A
STORM SHELTER PREPAREDNESS AND EMERGENCY OPERATIONS
PLAN (SSPEOP)

Section

Use of this document constitutes your agreement to abide by the User Agreement located at the beginning of this document.

A101	General	53
A102	Definitions	53
A103	SSPEOP Requirements	53
A104	SSPEOP Basic Information Requirements	53
A105	SSPEOP Preparedness Requirements	54
A106	SSEOP Emergency Operational Procedures Requirements	56

CHAPTER 1

APPLICATION AND ADMINISTRATION

SECTION 101 GENERAL

101.1 Purpose. The purpose of this standard is to establish minimum requirements to safeguard the public health, safety and general welfare relative to the design, construction and installation of *storm shelters* constructed for protection from tornadoes, hurricanes and other severe windstorms. This standard is intended for adoption by government agencies and organizations for use in conjunction with *applicable codes* to achieve uniformity in the technical design and construction of *storm shelters*.

101.2 Scope. This standard applies to the design, construction, installation and inspection of *storm shelters* constructed for the purpose of providing protection from tornadoes, hurricanes and other severe windstorms. *Storm shelters* shall be constructed as either separate detached buildings or rooms or spaces within new or existing buildings. Design of facilities for use as emergency shelters after the storm is outside the scope of this standard.

101.3 Requirements not included. Where requirements are not provided by this standard, the applicable provisions of the *applicable codes* adopted by the *authority having jurisdiction* shall apply to the *storm shelter*.

101.4 Referenced standards. The specific year, date and editions of the standards referenced by this standard are listed in Chapter 9.

SECTION 102 COMPLIANCE ALTERNATIVES

102.1 Compliance alternatives. Nothing in this standard is intended to prevent the use of designs, technologies or products as alternatives to any prescriptions in this standard, provided equivalence is demonstrated and *approved*.

SECTION 103 CONVENTIONS

IS-STM 03-11-23 AM errata

103.1 Dimensions. Dimensions stated as “maximum” or “minimum” are actual limits. All Dimensions that are not stated as “maximum” or “minimum” are nominal. Nominal All dimensions are subject to conventional industry tolerances unless otherwise noted.

103.2 Figures. Unless specifically stated, figures included herein are provided for informational purposes only and are not considered part of the standard.

Use of this document constitutes your agreement to abide by the User Agreement located at the beginning of this document.

SECTION 104 CONSTRUCTION AND OCCUPANCY

IS-STM 01-01-23 AM; IS-STM 01-02-23 AS/AFM BC1

104.2 104.1 Dedicated facilities—storm shelters. Where a **facility storm shelter** is designed to be occupied solely as a *storm shelter*, the designated occupancy shall be Group A-3 as defined by the *International Building Code*[®] for purposes of determination of applicable requirements that are not included in this standard.

Exceptions:

1. Where the **facility storm shelter** has a *design occupant capacity* of less than 50 persons the designated occupancy shall be in accordance with Section 303 of the *International Building Code*.
2. Where the **facility storm shelter** is a *residential storm shelter*, the designated occupancy shall be the Group R occupancy served as defined by the *International Building Code* or the **facility structure** shall comply with the *International Residential Code*[®], as applicable.

IS-STM 01-01-23 AM

104.1 104.2 Storm shelters occupied for other purposes Storm shelters within host buildings. Where a designated storm shelters is constructed as a room or space within a host building **Storm shelters** that will normally be occupied for other purposes **shall comply with** the requirements of the *applicable code* for the occupancy of the building, or the individual rooms or spaces thereof, **shall apply** unless otherwise required by ICC 500.

104.3 Design and construction. *Storm shelters* designed and constructed to this standard shall be designated as *hurricane shelters*, *tornado shelters* or combined *hurricane and tornado shelters*.

104.3.1 Combination storm shelters. Where the purpose of a *storm shelter* is to provide protection from both tornadoes and hurricanes, the entire *storm shelter* shall be designed and constructed using the most restrictive requirements for each hazard.

104.3.2 Storm shelters on islands in the Western North Pacific Ocean and South Pacific Ocean and in Alaska. *Storm shelters* located in Guam, the Northern Mariana Islands, American Samoa and Alaska shall be designed and constructed using the requirements for *hurricane shelters*.

SECTION 105 APPLICABLE CODE

105.1 Applicable code. Where construction of a *storm shelter* is to take place where no *applicable codes* are adopted, the applicable provisions of the *International Building Code* or the *International Residential Code*, shall apply.

SECTION 106 SUBMITTAL DOCUMENTS

IS-STM 01-02-23 AS

Use of this document constitutes your agreement to abide by the User Agreement located at the beginning of this document.

106.1 General. Submittal documents consisting of construction documents and other documentation shall be prepared and submitted to the *authority having jurisdiction* with each permit application. Such documents shall contain information as required by the *applicable code* and this standard. *Storm shelter* construction documents, including the design information listed in Section 106.2.1, shall be prepared and sealed by a registered design professional.

Exception: Where the following items are *listed* and *labeled* to indicate compliance with ICC 500, construction documents for those items are not required to be prepared and sealed by a registered design professional:

1. *Residential storm shelters.*
2. Structural components and *impact-protective systems* installed in *residential storm shelters.*

IS-STM 01-03-23 AM

106.2 Design Information required. The following information applicable to the design, construction, and operation of the *storm shelter* shall be supplied as part of the construction documents documented or explicitly referenced on a single sheet within the construction documents.

IS-STM 01-03-23 AM; IS-STM 01-04-23 AM; IS-STM 03-02-23 AM/AFM BC3; errata – Item 9 repeated

106.2.1 Design information. For the areas of a building designed for occupancy as a *storm shelter*, the following information shall be provided within the construction documents:

1. Type of *storm shelter*. Residential or community and tornado, hurricane or a combination of both.
2. Use of *community storm shelter*. use by the general public, building occupants or a combination of both.
3. A statement that the design conforms to the provisions of the ICC 500 *Standard for the Design and Construction of Storm Shelters*, with the edition year specified.
4. The *storm shelter* design tornado speed, V_T or design wind speed, V_T , V_H , or both, mph (m/s).
5. The tornado and wind exposure category (indicate all where more than one is used).
6. The directionality factor, K_d or K_{dT} or both.
7. The topographic factor, K_{zt} .
8. The internal pressure coefficient, GC_{pi} or GC_{piT} or both.
9. Design tornado pressure or design wind pressures and their applicable zones with dimensions needed for the specification of the components and cladding of the *storm shelter envelope*, psf (kN/m²) or both.
- ~~9. Design wind pressures and their applicable zones with dimensions needed for the specification of the components and cladding of the storm shelter envelope, psf (kN/m²).~~
10. Where the *storm shelter* is subject to the requirements of Section 402.1, a statement that the *storm shelter* has or has not been constructed in accordance with Chapter 4.
11. Where the *storm shelter* is subject to the requirements of Section 402.1, the minimum elevation of the lowest floor required by the *authority having jurisdiction* for the location where the *storm shelter* is installed; the base flood elevation, 500-year flood elevation

Use of this document constitutes your agreement to abide by the User Agreement located at the beginning of this document.

and *storm surge flood elevation* where applicable; and the *storm shelter* floor elevation. Where the National Hurricane Center's Sea, Lake and Overland Surges from Hurricanes (SLOSH) or other *approved* source is utilized for data, the construction documents shall indicate the version, date and the source of the maps.

12. Documentation showing that components of the *storm shelter envelope* will meet the static and cyclic pressure and impact test requirements identified in Chapters 3 and 8.
13. A floor plan drawing or image indicating location of the *storm shelter* on a site or within a building or facility; including a drawing or image indicating the entire facility.
14. A *storm shelter* section or elevation indicating the height of the *storm shelter* relative to the finished grade, finished floor and the *host building*, where applicable.
15. The lowest *storm shelter* floor elevation and corresponding datum, except for *residential tornado shelters* outside of special *flood hazard areas*.
16. The *design occupant capacity*.
17. Calculations for the *usable floor area*, in square feet (m²).
18. Calculations for the venting area provided and the locations in the *storm shelter*.
19. Calculations for the number of sanitation facilities for *community storm shelters*.
20. Minimum foundation capacity requirements including foundation thickness, steel reinforcement and concrete cover.
21. Installation requirements for prefabricated *storm shelters*, *Storm-storm shelter structural components*, and *impact-protective systems* installation requirements, including anchor location, minimum edge and end distance and minimum required capacity for all post-installed anchors.
22. For *hurricane shelters*, the rainfall rate of the roof primary drainage system.
23. For *hurricane shelters*, the rainfall rate of the roof secondary (overflow) drainage system where required.
24. For *hurricane shelters*, the rainwater drainage design rainfall rate for facilities subject to rainwater impoundment.

IS-STM 01-03-23 AM

106.2.2 Design information documentation. Design information listed in Section 106.2.1 and instructions listed in Section 106.2.6 shall be documented or explicitly referenced on a single sheet within the construction documents.

IS-STM 01-03-23 AM; IS-STM 01-05-23 AS

106.3 106.2.3 Storm shelter envelope Enclosure. Where a storm shelter is to be constructed as a portion of a host building, the The roofs, walls, and floors comprising enclosing the *storm shelter envelope* shall be clearly indicated in the construction documents on the drawings.

IS-STM 01-03-23 AM

106.4 106.2.4 Signage. The type and location of signs required by this standard shall be indicated on the floor plans.

IS-STM 01-03-23 AM; IS-STM 01-06-23 AS

Use of this document constitutes your agreement to abide by the User Agreement located at the beginning of this document.

106.5 106.2.5 Storm shelter details. The submittal construction documents shall provide or include any manufacturer's details or installation instructions for systems or equipment designed for the protection and operation of the *storm shelter*.

IS-STM 01-03-23 AM; IS-STM 01-06-23 AS

106.6 106.2.6 Storm shelter instructions. The submittal construction documents shall provide or include any details or instructions required for the functional operation of the *storm shelter*, such as:

1. Type and location of equipment and amenities required within the *storm shelter*, including water supply, sanitary facilities, fire extinguishers, batteries, flashlights, special emergency lighting equipment or any other equipment required to be installed in the *storm shelter*.
2. Specifications for any alarm system to be installed.
3. Instructions for the installation or deployment of any *impact-protective systems* such as shutters, screens, doors or windows.
4. Instructions for the installation, activation or deployment of any mechanical, electrical and plumbing equipment.

SECTION 107 QUALITY ASSURANCE PLAN

IS-STM 01-07-23 AS/AFM BC1

107.1 Quality assurance plan. The construction documents for *community storm shelters* shall contain a quality assurance plan prepared by a registered design professional in accordance with Sections 107.2 through 107.4. and shall identify the following:

IS-STM 01-07-23 AS

107.2 Detailed requirements. ~~A quality assurance plan shall be provided for the following:~~

1. Roof cladding, soffits and roof framing connections.
2. Wall connections to roof and floor diaphragms and framing.
3. Roof and floor diaphragm systems, including connectors, drag struts and boundary elements.
4. Main windforce-resisting systems, including braced frames, moment frames and shear walls.
5. Main windforce-resisting system connections to the foundation.
6. Fabrication and installation of Components and assemblies that are part of wall assemblies, roof assemblies or *impact-protective systems* of the *storm shelter envelope* required to meet impact or static or cyclic pressure test requirements of Chapter 3, such as, window assembly, door assembly, shutter assembly or louver.
7. Wall cladding and wall cladding connections.
8. Corrosion resistance or protection of exposed metal connectors providing load path continuity.
9. *Storm shelter critical support systems* and connections and impact protection of the components and connections.
10. Foundation design.

Use of this document constitutes your agreement to abide by the User Agreement located at the beginning of this document.

11. Prefabricated *storm shelter* installation requirements, including anchor location and minimum required capacity for each type of anchor.
12. Prefabricated *storm shelter* minimum foundation capacity requirements.

IS-STM 01-07-23 AS

~~107.3 Quality assurance plan preparation.~~ A quality assurance plan prepared by a registered design professional shall be provided for each main windforce-resisting system and wind-resisting components and cladding.

~~The quality assurance plan shall identify the following:~~

- ~~1. The main windforce-resisting systems and wind-resisting components and cladding.~~
- ~~2. The special inspections and testing to be required in accordance with Section 110.1.~~
- ~~3-13.~~ The type and frequency of testing required.
- ~~4-14.~~ The type and frequency of *special inspections* required in accordance with Section ~~110~~ **111**.
- ~~5-15.~~ The structural observations to be performed in accordance with Section ~~111.4 111~~ **112**.
- ~~6-16.~~ The required distribution, type and frequency of reports of test, inspections and structural observations.

IS-STM 01-08-23 AS

SECTION ~~109 108~~ PEER REVIEW

IS-STM 01-10-23 AS

~~109 108.1 Storm shelters requiring peer review.~~ A *peer review* shall be conducted for the following ~~community~~ *storm shelter* types:

1. ~~Community storm~~ *Storm* shelters with a design occupant capacity of 50 or greater.
2. *Storm shelters* in elementary schools, secondary schools and day care facilities with a design occupant capacity greater than 16.
3. *Storm shelters* for buildings and structures assigned to Risk Category IV (essential facilities) as defined in Table 1604.5 in the *International Building Code*.

~~109 108.2 Peer review.~~ The owner or the owner's authorized agent, other than the registered design professionals for the project, shall employ independent registered design professionals to conduct a *peer review* for compliance with the requirements of Sections 106, 107, ~~110 111~~ and ~~111 112~~ and Chapters 3, 4, 5, 6 and 7.

Exception: A registered design professional for the project is permitted to employ the peer reviewer where the registered design professional for the project is also the owner.

~~109 108.3 Peer reviewer disclosure.~~ The peer reviewer shall disclose to the owner or the owner's authorized agent and the *authority having jurisdiction* any possible conflicts of interest, financial or otherwise.

~~109 108.4 Peer reviewer qualifications.~~ The peer reviewers shall provide written documentation to the owner or owner's authorized agent demonstrating relevant experience and training in the **Use of this document constitutes your agreement to abide by the User Agreement located at the beginning of this document.**

specific areas of practice being peer reviewed and for projects similar in complexity to the type of *storm shelter* design under review.

409 108.5 Peer review report. A signed and sealed report shall be submitted to the owner or owner's authorized agent and to the *authority having jurisdiction* with the construction documents prior to the issuance of a permit for construction. The report shall describe the items reviewed, provide an explanation of noncompliant issues, and recommend acceptance or rejection of the items reviewed.

IS-STM 01-08-23 AS /AFM BC1

409 108.5.1 Changes. The registered design professional in responsible charge shall submit to the peer reviewer changes to the main windforce-resistance system or components and cladding that occur after the peer review report, that are related to the requirements of Section **409.4 108.2** and occur before the issuance of permits for construction. If determined to be needed by the authority having jurisdiction, an amended peer review report shall be submitted before such design changes are implemented.

IS-STM 01-08-23 AS

SECTION 408 109 OWNER'S RESPONSIBILITY

408 109.1 Owner's statement of responsibility. For each *community storm shelter*, the owner shall submit to the *authority having jurisdiction* a written statement of responsibility acknowledging the owner's responsibilities regarding shelter operation and maintenance with the application for a construction permit.

408 109.2 Preparedness and emergency operations plan. For each *community storm shelter*, the owner or the owner's authorized agent shall submit to the *authority having jurisdiction* a written preparedness and emergency operations plan for the *storm shelter* prior to approval of the certificate of occupancy.

IS-STM 01-09-23 AM/AFM BC1

408 109.3 Evaluation and maintenance plan. For each *community storm shelter*, the owner or the owner's authorized agent shall submit to the *authority having jurisdiction* a written evaluation and maintenance plan in accordance with Section 113.

IS-STM 01-08-23 AS

SECTION 110 CONTRACTOR'S STATEMENT OF RESPONSIBILITY

110.1 107.4 Contractor's statement of responsibility. Each contractor responsible for the construction, fabrication or installation of a main windforce-resisting system, *impact-protective system* or any component listed in the quality assurance plan shall submit a written statement of responsibility to the *authority having jurisdiction*, the responsible design professional and the owner or

Use of this document constitutes your agreement to abide by the User Agreement located at the beginning of this document.

the owner's authorized agent prior to the commencement of work on the system or component. The contractor's statement of responsibility shall contain:

1. Acknowledgement of awareness of the special requirements contained in the quality assurance plan.
2. Acknowledgement that control will be exercised to obtain compliance with the construction documents.
3. Procedures for exercising control within the contractor's organization, the method and frequency of reporting and the distribution of reports.
4. Identification and qualifications of the person exercising such control and their position in the organization.

Exception: A written statement of responsibility shall not be required for the fabrication of *storm shelter* components that have been inspected and *labeled* by an *approved agency* as meeting the requirements of the *applicable code* and this standard.

IS-STM 01-08-23 AS

SECTION 110 111 SPECIAL INSPECTIONS

110 111.1 Special inspections. *Special inspections* shall be provided in accordance with this section, in addition to those required by the *authority having jurisdiction* in accordance with the *applicable code*.

One statement of *special inspections* shall be permitted to apply to both *host building* and *storm shelter* construction.

110 111.1.1 Inspection of fabricators. Where fabrication of structural load-bearing and impact-resistant components and assemblies is being performed on the premises of a fabricators shop, special inspection of the fabricator shall be provided.

Exception: Prefabricated or panelized *storm shelter* components that have been inspected and *labeled* by an *approved agency* meeting the requirements of the *applicable code*.

110 111.1.2 Special cases. *Special inspections* shall be provided for proposed work comprised of the following:

1. Construction materials and systems that are alternatives to traditional materials and systems prescribed by the *applicable code*.
2. Unusual design and construction applications.
3. Anchors post-installed in hardened concrete and masonry, where used for anchorage of *storm shelter* components forming a part of the *storm shelter* enclosure or for anchorage of the *storm shelter* structure to foundations shall be in accordance with Section 110.1.2.1.

110 111.1.2.1 Special inspections to verify anchor installation. A *special inspection* shall be provided to verify the post-installed anchor installation and capacity in accordance with Section 106.2.1. For post-installed anchorage to foundations, *special inspection* shall be provided to verify foundation adequacy in accordance with Sections 106.2.1 and 307.

Exception: For *residential storm shelters*, where the *authority having jurisdiction* verifies that the anchorage and, where required, the foundation complies with the requirements of

the *storm shelter* design as provided in documentation required by Section 106, *special inspection* is permitted to be waived by the *authority having jurisdiction*.

IS-STM 01-08-23 AS

SECTION ~~111~~ **112** STRUCTURAL OBSERVATIONS

444 **112.1 Structural observations.** During construction of *community storm shelters*, the building owner shall employ a registered design professional to conduct visual observations of the construction of the structural system for general conformance to the *approved* construction documents at significant construction stages and at completion of the construction of the structural system. Structural observation shall not obviate the need for other inspections or testing required by this standard or the *applicable code*.

Deficiencies shall be reported in writing to the *authority having jurisdiction* and owner or the owner's authorized agent. At the conclusion of the work, the registered design professional who made the structural observations shall submit to the *authority having jurisdiction* a written statement that the site visits have been made and shall identify any reported deficiencies that, to the best of the structural observer's knowledge, have not been resolved.

IS-STM 01-08-23 AS; IS-STM 01-11-23 AM relocated to 306.4

~~SECTION 112~~ ~~LISTING AND LABELING~~

IS-STM 01-11-23 AM relocated to 306.4.1.1

~~112.1 Listing and labeling.~~ *Impact protective systems* shall be *listed* and *labeled* denoting compliance with this standard.

IS-STM 01-11-23 AM relocated to 306.4.1.1.1

~~112.1.1 Marking.~~ The following function and performance characteristics shall be provided on the *label* for each *impact protective system* tested:

- ~~1. Manufacturer's identification reference or listing number for the assembly~~
- ~~2. Type of *impact protective system*, such as window assembly, door assembly, shutter assembly or louver.~~
- ~~3. Hazard: hurricane, tornado or both.~~
- ~~4. Missile weight and speed.~~
- ~~5. *Design wind pressure*.~~
- ~~6. Edition of ICC 500.~~

IS-STM 01-08-23 AS (end result is no change to main section number)

SECTION 113 EVALUATION, MAINTENANCE AND REPAIRS

IS-STM 01-09-23 AM/AFM BC1

113.1 General. Community shelters shall be evaluated and maintained in accordance with Sections 113.2 through ~~113.4~~ **113.5**.

Use of this document constitutes your agreement to abide by the User Agreement located at the beginning of this document.

IS-STM 01-09-23 AM/AFM BC1

113.2 Evaluation and maintenance plan. The owner or the owner's authorized agent shall develop and maintain a written evaluation and maintenance plan.

IS-STM 01-09-23 AM/AFM BC1

113.3 113.2 Evaluation. The owner or owner's authorized agent shall evaluate the *storm shelter* annually and when requested by the *authority having jurisdiction*. The evaluation of the *storm shelter* shall include the following:

1. The *storm shelter envelope* shall be evaluated through visual observation to assess whether the walls and roofs are intact and undamaged.
2. *Impact-protective systems* shall be evaluated for compliance with the manufacturer's operational and maintenance requirements.
3. *Critical support systems* evaluation, maintenance, and repair records shall be reviewed for compliance with Section ~~113.3.3-113.4.3~~.

IS-STM 01-09-23 AM/AFM BC1

113.4 113.3 Maintenance and repairs. *Storm shelters* shall be maintained in an operational operable condition at all times. All structural ~~and operational~~ elements, impact-protective systems and critical support systems shall be repaired or replaced where damaged or found to be inoperable.

IS-STM 01-09-23 AM/AFM BC1

113.4.1 113.3.1 Damaged or missing components. *Storm shelters* shall be maintained so that walls and roofs are intact and undamaged. Any damage to the *storm shelter* or its *impact-protective systems* that impair its functionality shall be repaired or replaced. Damaged or missing components shall be replaced with components that are specified within the tested or *listed* assembly.

IS-STM 01-09-23 AM/AFM BC1

113.4.2 113.3.2 Replacement assemblies and systems. Where it is necessary to replace assemblies certified or listed impact-protective systems, replacements shall comply with applicable ICC 500 requirements, and shall be ~~tested and~~ installed as required by this standard for new installations or construction.

IS-STM 01-09-23 AM/AFM BC1

113.4.3 113.3.3 Critical support systems. *Critical support systems* shall be maintained and repaired in compliance with manufacturers requirements and Section ~~108.3-109.3~~. Stored supplies such as generator fuel and water supply shall be maintained at appropriate levels in accordance with Section ~~108.3-109.3~~.

IS-STM 01-09-23 AM/AFM BC1

113.5 113.4 Recordkeeping. A record of the evaluations shall be maintained by the owner or owner's authorized agent. A record of the evaluations, and any other tests, repairs or replacements, and other operations and maintenance shall be kept on the premises or other *approved* location, and consist of all All changes to the original *storm shelter envelope*, ~~or~~ *impact-protective*
Use of this document constitutes your agreement to abide by the User Agreement located at the beginning of this document.

systems or critical support systems shall be recorded. Records shall include the date and person conducting the evaluations and maintenance or repairs.

CHAPTER 2

DEFINITIONS

SECTION 201 GENERAL

201.1 General. For the purposes of this standard, the terms listed in Section 202 shall have the indicated meaning.

201.2 Undefined terms. The terms not specifically defined in this standard or in standards referenced herein shall have ordinarily accepted meanings such as the context implies.

201.3 Interchangeability. Words used in the present tense include the future; words stated in the masculine gender include the feminine and neuter; the singular number includes the plural and the plural, the singular.

SECTION 202 DEFINITIONS

500-YEAR FLOOD. The flood having a 0.2 percent chance of being equaled or exceeded in any given year.

500-YEAR FLOOD ELEVATION. The elevation of the *500-year flood*, including wave height.

500-YEAR FLOOD HAZARD AREA. The area subject to the *500-year flood*.

ALCOVE STORM SHELTER ENTRY SYSTEM. See “Entry system, alcove or baffled storm shelter.”

APPLICABLE CODE. The regulation for design and construction of buildings and structures adopted by the *authority having jurisdiction* over the construction of the specific *storm shelter*.

APPROVED. Acceptable to the authority having jurisdiction.

IS-STM 02-01-23 AS

[A] APPROVED AGENCY. An established and recognized agency organization that is regularly engaged in conducting tests, furnishing inspection services or furnishing product evaluation or certification where such agency organization has been *approved*.

AREAS OF CONCENTRATED FURNISHINGS. The areas of a *storm shelter* with furniture or fixtures that cannot be moved easily, including areas such as bathrooms, locker rooms and rooms with fixed seating or fixed tables.

AREAS OF OPEN PLAN FURNISHINGS. The areas of a *storm shelter* that are generally free of furniture or fixtures that cannot be moved easily and of interior partitions or other features that block movement through, or otherwise subdivide, the space.

AREAS OF UNCONCENTRATED FURNISHINGS. The areas of a *storm shelter* with furniture or fixtures that can be moved easily, including areas such as classrooms and offices.

Use of this document constitutes your agreement to abide by the User Agreement located at the beginning of this document.

AUTHORITY HAVING JURISDICTION. The organization, political subdivision, office or individual charged with the responsibility for administering and enforcing the provisions of this standard.

BAFFLED STORM SHELTER ENTRY SYSTEM. See “Entry system, alcove or baffled storm shelter.”

BASE FLOOD. The flood having a 1-percent chance of being equaled or exceeded in any given year.

IS-STM 02-01-23 AS

[BS] BASE FLOOD ELEVATION. The elevation of the *base flood*, including wave height, relative to the National Geodetic Vertical Datum (NGVD), North American Vertical Datum (NAVD) or other datum specified on the *Flood Insurance Rate Map (FIRM)*.

COASTAL A ZONE. Area within a special *flood hazard area*, landward of a V zone or landward of an open coast without mapped *coastal high-hazard areas*. In a *coastal A zone*, the principal source of flooding is astronomical tides, storm surges, seiches or tsunamis, not riverine flooding. During the *base flood* conditions, the potential for breaking wave height is greater than or equal to 1½ feet (457 mm). The inland limit of the *coastal A zone* is one of the following:

1. The Limit of Moderate Wave Action if delineated on a FIRM.
2. Designated by the *authority having jurisdiction*.

COASTAL HIGH-HAZARD AREA. Area within the special *flood hazard area* extending from offshore to the inland limit of a primary dune along an open coast and any other area that is subject to high-velocity wave action from storms or seismic sources, and shown on a Flood Insurance Rate Map (FIRM) or other flood hazard map as velocity Zone V, VO, VE or V1-30.

IS-STM 02-02-23 AM; correlation with IS-STM 07-06-23 for order or requirements; 07-02-23 AS/AFM BC1

CRITICAL SUPPORT SYSTEMS, STORM SHELTER. Systems and components required by Chapter 7 to ensure the health, safety, and well-being of shelter occupants. Critical support systems include, water closets, lavatories, sanitation support systems, drinking water, roof drainage systems, ventilation systems, lighting systems, potable water and waste water systems, emergency and standby power system, and emergency power systems, and lighting systems, and ventilation systems.

DESIGN OCCUPANT CAPACITY. The number of occupants for which the *storm shelter* is designed.

IS-STM 03-02-23 AM

DESIGN TORNADO PRESSURE. For *tornado shelters*, the tornado pressure on a specific location of the *storm shelter envelope*, as determined in accordance with Section 304, which controls the design of components and cladding (C & C) of the *storm shelter envelope* or the main wind force resisting system (MWFRS) for the *storm shelter*.

IS-STM 03-02-23 AM

DESIGN WIND PRESSURE. For *hurricane shelters*, The the wind pressure on a specific location of the *storm shelter envelope*, as determined in accordance with Section 304, Wind Loads, which controls the design of components and cladding (C & C) of the *storm shelter envelope* or the main wind force resisting system (MWFRS) for the *storm shelter*.

ENTRY SYSTEM, ALCOVE OR BAFFLED STORM SHELTER. An entry system that uses walls and passageways to allow access to and egress from the *protected occupant area* while providing shielding from wind-borne debris.

ENVELOPE, STORM SHELTER. The roofs, walls and floors and the *impact-protective systems* that provide protection to occupants during a severe windstorm and meet the requirements of Chapter 3.

FALLING DEBRIS HAZARDS. See “Hazards, falling debris.”

FIRE BARRIER. A fire-resistance-rated wall assembly of materials designed to restrict the spread of fire in which continuity is maintained.

FLOOD ELEVATION. The *base flood elevation, 500-year flood elevation or storm surge flood elevation* applicable for the design and construction of a *storm shelter*.

FLOOD ELEVATION STUDY. An examination, evaluation and determination of flood hazard and, where appropriate, corresponding water surface elevations, or an examination, evaluation and determination of storm surge inundation, including coastal wave effects, associated with the maximum intensity hurricane.

FLOOD HAZARD AREA. The greater of the following two areas:

1. The area in a floodplain subject to the *base flood*.
2. The area designated as a *flood hazard area* on a community’s flood hazard map, or otherwise legally designated.

FURNISHINGS. See “Areas of concentrated furnishings,” “Areas of open plan furnishings” and “Areas of unconcentrated furnishings.”

IS-STM 03-02-23 AM

HAZARDS.

Coastal. See “Coastal high hazard area.”

Falling debris. Exterior components, cladding, and appurtenances, such as parapet walls, masonry cladding, or rooftop equipment, that could fall onto the roof of a *storm shelter* from **wind windstorm** damage to adjacent, taller buildings or taller sections of a *host building*.

Flood. See “500-year flood hazard area” and “Flood hazard area.”

Laydown. Adjacent building elements, other structures and natural objects, that could fall onto the roof of a *storm shelter*, such as exterior walls of adjacent single story structures, self-supporting towers, poles or large trees.

Storm surge. See “Storm surge flood hazard area.”

HORIZONTAL ASSEMBLY. A fire-resistance-rated floor or *roof assembly* of materials designed to restrict the spread of fire in which continuity is maintained.

HOST BUILDING. A building that is not designed or constructed as a *storm shelter* that totally or partially encloses, or is connected to, a *storm shelter*.

HURRICANE SHELTER. A *storm shelter* specifically for use to protect occupants during hurricanes.

IMPACT-PROTECTIVE SYSTEM. An assembly or device, subject to static or cyclic pressure and impact testing as detailed in this standard, installed to protect an opening in the *storm shelter envelope*.

Use of this document constitutes your agreement to abide by the User Agreement located at the beginning of this document.

LABEL. An identification applied on a product by the manufacturer that contains the name of the manufacturer, the function and performance characteristics of the product or material, and the name and identification of an *approved agency* and that indicates that the representative sample of the product or material has been tested and evaluated by an *approved agency*.

LABELED. Equipment, materials or products to which has been affixed a *label*, seal, symbol or other identifying mark of a nationally recognized testing laboratory, *approved agency* or other organization concerned with product evaluation that maintains periodic inspection of the production of the above-labeled items and whose labeling indicates either that the equipment, material or product meets identified standards or has been tested and found suitable for a specified purpose.

LAYDOWN HAZARDS. See “Hazards, laydown.”

IS-STM 02-01-23 AS

LISTED. Equipment, materials, products or services included in a list published by an *approved* organization and concerned with evaluation of products or services that maintains periodic inspection of production of *listed* equipment or materials or periodic evaluation of services and whose listing states either that the equipment, material, product or service meets identified standards or has been tested and found suitable for a specified purpose. Terms that are used to identify listed equipment, products, or materials include “listed”, “certified”, “classified” or other terms as determined appropriate by the listing organization.

NATURAL VENTILATION. Passive ventilation, not requiring a power source, resulting from convection of heated air, movement of inside air and movement of outside air over and around the *storm shelter* resulting in air exchange through vent openings.

OCCUPANT SUPPORT AREAS. Areas within the *storm shelter envelope* provided to serve the health, safety and well-being of occupants including, but not limited to, *storm shelter* management, food preparation, storage, electrical and mechanical rooms, toilet and other sanitation rooms and first-aid stations.

OCCUPIED STORM SHELTER AREAS. The designated *storm shelter* area within the *storm shelter envelope*.

IS-STM 01-02-23 AS/AFM BC1

ON-SITE. Either inside, immediately adjacent to, or on the same site as the designated *storm shelter facility*, and under the control of the owner or lawful tenant.

IS-STM 02-06-23 AS

PROTECTED OCCUPANT AREA. The portions of the *storm shelter* area that are protected from intrusion of storm wind-borne debris.

REBOUND IMPACT. The impact by a test missile, or fragments thereof, on a portion of the *storm shelter envelope* after the test missile has impacted another surface of the *storm shelter envelope*.

ROLLING DOOR ASSEMBLY. A vertically operating coiling door made of a curtain consisting of formed metal slats interlocking together, supported by a barrel assembly at the top of the opening, operating by means of door guides at the jambs.

SECTIONAL DOOR ASSEMBLY. A vertically operating door made of two or more horizontal sections hinged together, operating by means of tracks and track rollers at the jambs.

IS-STM 02-01-23 AS

Use of this document constitutes your agreement to abide by the User Agreement located at the beginning of this document.

SPECIAL INSPECTION. Inspection of construction requiring the expertise of **a an approved** *special inspector* in order to ensure compliance with this standard and the *approved* construction documents.

SPECIAL INSPECTOR. A qualified person employed or retained by an *approved agency* and *approved* as having the competence necessary to inspect a particular type of construction requiring *special inspection*.

SPECIMEN. The entire assembled unit submitted for testing, including but not limited to anchorage devices to which the product is to be mounted.

IS-STM 02-07-23 AS

STORM SHELTER. A building, structure or portion thereof, constructed in accordance with this standard, **designated for use during for protection from** tornadoes, hurricanes and other severe windstorms.

Community Storm Shelter. Any *storm shelter* not defined as a *residential storm shelter*. This includes *storm shelters* intended for use by the general public, by building occupants or a combination of both.

Residential Storm Shelter. A *storm shelter* serving occupants of dwelling units and having a *design occupant capacity* not exceeding 16 persons.

STORM SURGE FLOOD. The flooding associated with the maximum storm surge inundation associated with the maximum intensity hurricane modeled using an *approved* source such as the National Hurricane Center's Sea, Lake and Overland Surges from Hurricanes (SLOSH).

STORM SURGE FLOOD ELEVATION. The elevation corresponding to the *storm surge flood*, including coastal wave effects

STORM SURGE FLOOD HAZARD AREA. The area subject to the *storm surge flood*

TEST CHAMBER. An airtight enclosure of sufficient depth to allow unobstructed deflection of the *specimen* during pressure cycling, including ports for air supply and removal, and equipped with instruments to measure test pressure differentials.

TEST LABORATORY. A testing agency accredited to conduct impact and static and cyclic pressure testing as required in Chapter 8.

TORNADO SHELTER. A *storm shelter* specifically for use to protect occupants during tornadoes.

USABLE FLOOR AREAS. The portions of the floor area within the *storm shelter envelope* not including *occupant support areas*, used to determine the *design occupant capacity of the storm shelter*.

IS-STM 03-02-23 AM

WIND PRESSURE. See "Design wind pressure;" **and "Design tornado pressure."**

SECTION 203 SYMBOLS AND NOMENCLATURE

IS-STM 03-02-23 AM

APC = atmospheric pressure change.

D = dead load.

F_{aH} = flood load on *hurricane shelters* in accordance with Section 303.5.

GC_{pi} = internal pressure coefficient.

Use of this document constitutes your agreement to abide by the User Agreement located at the beginning of this document.

GC_{piT} = ~~internal~~ tornado ~~internal~~ pressure coefficient.

L = uniform live load for floors in *hurricane shelters* in accordance with the *applicable code* for the normal use of the space.

L_T = uniform live load for floors in *tornado shelters* in accordance with Section 303.2.

L_{rH} = roof live load for *hurricane shelters* in accordance with Sections 303.3 and 305.3.

L_{rT} = roof live load for *tornado shelters* in accordance with Sections 303.3 and 305.3.

LRFD = load and resistance factor design.

K_d = directionality factor for wind loads.

K_{dT} – directionality factor for tornado loads

~~K_{zt} – topographic factor~~

MWFRS = main wind force-resisting system.

R_H = rain load for *hurricane shelters* in accordance with Section 303.1.1.

R = rain load for *tornado shelters* in accordance with the *applicable code*.

V_H = design wind speed for hurricanes.

V_T = design wind tornado speed for tornadoes.

W_H = load due to hurricane winds.

W_T = load due to ~~tornadoes winds~~ tornadic winds.

CHAPTER 3

STRUCTURAL DESIGN AND TESTING CRITERIA

SECTION 301 GENERAL

301.1 Scope. The requirements of this chapter shall govern the structural design and testing criteria of *storm shelters*.

301.2 General design requirements. *Storm shelters* shall be designed to resist the loads and load combinations as prescribed by this chapter in addition to the loads and load combinations prescribed in the *applicable code*.

301.3 General testing requirements. Where the capacity of *storm shelter envelope* components cannot be determined by engineering calculations in accordance with Section 301.2, it shall be determined through testing in accordance with Section 306.

IS-STM 03-02-23 AM

301.4 Performance based design for tornado loads. Where tornado loads are determined using a performance-based procedure~~s~~, the tornado loads shall be in accordance with ASCE 7 Section 32.1.3, providing loads are not lesser in magnitude than required by this chapter.

IS-STM 03-02-23 AM

301.5 Performance based design for wind loads. Where wind loads are determined using a performance-based procedure~~s~~, the wind loads shall be in accordance with ASCE 7 Section 26.1.3, providing loads are not lesser in magnitude than required by this chapter.

SECTION 302 LOAD COMBINATIONS

302.1 General. The *storm shelter* shall be designed to resist the load combinations specified in Section 302.2 or 302.3. *Storm shelters* that are designed as combination tornado and *hurricane shelters* shall comply with requirements for both sets of load combinations using either Section 302.2 or 302.3.

IS-STM 03-01-23 AS

302.2 Strength design. Where strength design or load and resistance factor design (LRFD) is used, *storm shelters* and portions thereof shall be designed to resist the most critical effects resulting from the following combinations of factored loads. Each load combination shall also be investigated with one or more of the variable loads set to zero.

For *tornado shelters*:

$$1.4D \text{ (Equation 3-1)}$$

$$1.2D + 1.6L_T + 0.5L_{rT} \text{ (Equation 3-2 Equation 3-1)}$$

Use of this document constitutes your agreement to abide by the User Agreement located at the beginning of this document.

$$1.2D + 1.6L_{rT} + (L_T \text{ or } 0.5W_T) \quad (\text{Equation 3-3 Equation 3-2})$$

$$1.2D + 1.0W_T + L_T + 0.5L_{rT} \quad (\text{Equation 3-4 Equation 3-3})$$

$$0.9D + 1.0W_T \quad (\text{Equation 3-5 Equation 3-4})$$

For *hurricane shelters*:

$$1.4D \quad (\text{Equation 3-6})$$

$$1.2D + 1.6L + (0.5(L_{rH} \text{ or } 1.0R_H)) \quad (\text{Equation 3-7 Equation 3-5})$$

$$1.2D + (1.6(L_{rH} \text{ or } 1.0R_H) + (L \text{ or } 0.5W_H)) \quad (\text{Equation 3-8 Equation 3-6})$$

$$1.2D + 1.0W_H + L + (0.5(L_{rH} \text{ or } 1.0R_H)) \quad (\text{Equation 3-9 Equation 3-7})$$

$$0.9D + 1.0W_H \quad (\text{Equation 3-10 Equation 3-8})$$

In addition, for *hurricane shelters* subject to the requirements of Section 402.1 and located in:

Coastal high-hazard area or a *Coastal A Zone*:

$$1.2D + 1.0W_H + 2.0F_{aH} + L + 0.5(L_{rH} \text{ or } R_H) \quad (\text{Equation 3-11 Equation 3-9})$$

$$0.9D + 1.0W_H + 2.0F_{aH} \quad (\text{Equation 3-12 Equation 3-10})$$

All other locations:

$$1.2D + 0.5W_H + 1.0F_{aH} + L + 0.5(L_{rH} \text{ or } R_H) \quad (\text{Equation 3-13 Equation 3-11})$$

$$0.9D + 0.5W_H + 1.0F_{aH} \quad (\text{Equation 3-14 Equation 3-12})$$

IS-STM 03-01-23 AS

302.3 Allowable stress design. Where allowable stress design (ASD, working stress design) is used, *storm shelters* and portions thereof shall be designed to resist the most critical effects resulting from the following combinations of loads. Each load combination shall also be investigated with one or more of the variable loads set to zero.

For *tornado shelters*:

$$D + L_T \quad (\text{Equation 3-15 Equation 3-13})$$

$$D + L_{rT} \quad (\text{Equation 3-16 Equation 3-14})$$

$$D + 0.75L_T + 0.75L_{rT} \quad (\text{Equation 3-17 Equation 3-15})$$

$$D + 0.6W_T \quad (\text{Equation 3-18 Equation 3-16})$$

$$D + 0.75L_T + 0.75(0.6W_T) + 0.75L_{rT} \quad (\text{Equation 3-19 Equation 3-17})$$

$$0.6D + 0.6W_T \quad (\text{Equation 3-20 Equation 3-18})$$

For *hurricane shelters*:

$$D + L \quad (\text{Equation 3-21})$$

$$D + (L_{rH} \text{ or } 0.7R_H) \quad (\text{Equation 3-22 Equation 3-19})$$

$$D + 0.75L + (0.75(L_{rH} \text{ or } 0.7R_H)) \quad (\text{Equation 3-23 Equation 3-20})$$

$$D + 0.6W_H \quad (\text{Equation 3-24 Equation 3-21})$$

$$D + 0.75L + 0.75(0.6W_H) + (0.75(L_{rH} \text{ or } 0.7R_H)) \quad (\text{Equation 3-25 Equation 3-22})$$

$$0.6D + 0.6W_H \quad (\text{Equation 3-26 Equation 3-23})$$

In addition, for *hurricane shelters* subject to the requirements of Section 402.1 and located in:

Coastal high-hazard area or a *Coastal A Zone*:

$$D + 0.6W_H + 1.5F_{aH} \quad (\text{Equation 3-27 Equation 3-24})$$

$$D + 0.75L + 0.75(0.6W_H) + 0.75(L_{rH} \text{ or } R_H) + 1.5F_{aH} \quad (\text{Equation 3-28 Equation 3-25})$$

$$0.6D + 0.6W_H + 1.5F_{aH} \quad (\text{Equation 3-29 Equation 3-26})$$

All other locations:

$$D + 0.75L + 0.75(0.6W_H) + 0.75(L_{rH} \text{ or } R_H) + 0.75F_{aH} \quad \text{(Equation 3-30 Equation 3-27)}$$

$$0.6D + 0.6W_H + 0.75F_{aH} \quad \text{(Equation 3-34 Equation 3-28)}$$

SECTION 303 LOADS

303.1 Rain loads. Rain loads shall be determined in accordance with the *applicable code*.

303.1.1. Rainfall rate. For *hurricane shelter* roofs the rainfall rate shall be determined by adding 6 inches (152 mm) of rainfall per hour to the 100-year, 1-hour rainfall rate. The 100-year, 1-hour rainfall rate shall be determined from Figures 303.1.1(1) through 303.1.1(5) or *approved* local weather data.

FIGURE 303.1.1(1)
100-YEAR, 1-HOUR RAINFALL (INCHES), EASTERN/CENTRAL UNITED STATES

FIGURE 303.1.1(2)—continued
100-YEAR, 1-HOUR RAINFALL (INCHES), CENTRAL UNITED STATES

FIGURE 303.1.1(3)—continued
100-YEAR, 1-HOUR RAINFALL (INCHES), WESTERN UNITED STATES

FIGURE 303.1.1(4)—continued
100-YEAR, 1-HOUR RAINFALL (INCHES), ALASKA

FIGURE 303.1.1(5)—continued
100-YEAR, 1-HOUR RAINFALL (INCHES), HAWAII

303.2 Floor live loads. *Community tornado shelter* floors shall be designed for not less than the minimum uniform live loads for assembly occupancies in accordance with the *applicable codes*. *Community hurricane shelter* floors shall be designed for not less than the minimum uniform live load for the normal occupancy of the space.

303.3 Roof live loads. *Storm shelter* roofs shall be designed for minimum live loads specified in the *applicable code*, but not less than the following:

Tornado shelters: 100 pounds per square foot (4.8 kN/m²)

Hurricane shelters: 50 pounds per square foot (2.4 kN/m²)

Where a *storm shelter* roof is subject to *laydown* or *falling debris hazards*, roof live loads shall also comply with Section 305.3.

303.3.1 Wheel loads. *Storm shelters* subject to vehicle loads shall be designed for vehicle loads in accordance with Section 1607 of the *International Building Code*, Section R301.5 of the *International Residential Code* or Section 4.10 of ASCE 7, as applicable.

303.4 Hydrostatic loads. Underground portions of *storm shelters* shall be designed for buoyancy forces and hydrostatic loads assuming that the ground water level is at the surface of the ground at the entrance to the storm shelter, unless adequate drainage is available to justify designing for a lower ground water level.

Use of this document constitutes your agreement to abide by the User Agreement located at the beginning of this document.

303.5 Flood loads. Where subject to the requirements of Section 402.1, *flood loads*, including wave action, shall be determined using a *flood elevation* not less than the minimum floor elevation in Section 402.6.

IS-STM 03-02-23 AM

SECTION 304 **TORNADO LOADS AND WIND LOADS**

IS-STM 03-02-23 AM

304.1 General. Wind loads from hurricanes, W_H , and tornadoes Tornado loads, W_T , wind loads for hurricanes, W_H , and wind loads for storms in Alaska, W_H , shall be determined in accordance with ASCE 7, Chapters 26 through ~~31~~ 32, except as modified by this section. For tornado loads the procedures from ASCE 7 Section 32.1.2 shall be applicable.

IS-STM 03-02-23 AM

304.2 Design tornado wind speed. For *tornado shelters*, the design wind tornado speed, V_T , shall be in accordance with Figure 304.2(1).

IS-STM 03-02-23 AM

Notes:

1. Values are nominal three-second gust wind speeds in miles per hour at 33 feet (10 058 mm) above ground for Exposure Category C.
2. Multiply miles per hour by 0.477 to obtain meters per second.
3. Location-specific storm shelter design wind tornado speeds shall be permitted to be determined using the ATC Hazards by Location website, <https://hazards.atcouncil.org/>.

FIGURE 304.2(1)

DESIGN WIND TORNADO SPEEDS, V_T , FOR TORNADOES

IS-STM 03-02-23 AM

304.3 Design wind speed. For *hurricane shelters*, the design wind speed, V_H , shall be in accordance with Figure ~~304.2(2)~~ 304.3(1) through 304.3(3). For *storm shelters* in Alaska, the design wind speed, V_H , shall be in accordance with Figure ~~304.2(3)~~ 304.3(4).

Errata – removed footnote 5

FIGURE ~~304.2(2)~~ 304.3(1)

DESIGN WIND SPEEDS, V_H , FOR HURRICANES

Errata – removed footnote 5

FIGURE ~~304.2(2)~~ 304.3(2)—continued

DESIGN WIND SPEEDS, V_H , FOR HURRICANES—WESTERN GULF OF MEXICO

Errata – removed footnote 5

FIGURE ~~304.2(2)~~ 304.3(3)—continued

DESIGN WIND SPEEDS, V_H , FOR HURRICANES—EASTERN GULF OF MEXICO AND

Use of this document constitutes your agreement to abide by the User Agreement located at the beginning of this document.

SOUTHERN ATLANTIC

Errata – removed footnote 5

FIGURE 304.2(3) 304.3(4)

DESIGN WIND SPEEDS, V_H , FOR —ALASKA

IS-STM 03-02-23 AM

304.4 304.3 Tornado and wind directionality factor factors. The directionality factors for tornado loads, K_{dT} , and the directionality factors for wind loads, K_d , shall be taken as $K_d = 1.0$.

IS-STM 03-02-23 AM

304.5 304.4 Exposure category. For *tornado shelters*, wind loads shall be based on Exposure Category C. For *hurricane shelters*, use of that are located in Exposure Category B is not permitted in accordance with ASCE 7 Section 26.7, Exposure C shall be used.

Exception: For *hurricane shelters*, wind *Wind* loads for the main wind force-resisting system (MWFRS) only shall be permitted to be based on Exposure Category B, where Exposure Category B exists for all wind directions and is likely to remain Exposure Category B after a hurricane with *design* wind speeds as determined from Section **304.3 304.2**.

IS-STM 03-02-23 AM

304.5 Topographic effects. For *tornado shelters*, the topographic factor, K_{zt} , need not exceed 1.0.

304.6 Enclosure classifications. Enclosure classifications for *storm shelters* shall be determined in accordance with ASCE 7, Chapter 26. For determining the enclosure classification for *community storm shelters*, the largest opening protected by an *impact-protective system* on a wall that receives positive external pressure shall be considered as an opening.

IS-STM 03-02-23 AM

304.7 Tornado Internal Pressure Coefficient for Enclosed Buildings Atmospheric Pressure Change (APC). For *tornado shelters* classified as enclosed buildings, the additional internal pressures caused by atmospheric pressure change shall be included in the design. The internal pressure coefficient, GC_{piT} , shall be taken as ± 0.18 where *atmospheric pressure change* (APC) venting area of 1 square foot (0.0929 m²) per 1,000 cubic feet (28.3 m³) of interior *storm shelter* volume is provided. APC venting shall consist of openings in the *storm shelter* roof having a pitch 10 degrees or less from the horizontal or openings divided equally (within 10 percent of one another) on opposite walls. A combination of APC venting meeting the above requirements is permitted.

Exception: Calculation of venting area to relieve APC is not required for *tornado shelters* classified as partially enclosed buildings. An internal pressure coefficient of $GC_{piT} = \pm 0.55$ shall be used for *tornado shelters* where APC venting meeting the requirements of Section 304.7 is not provided, or where APC venting area requirements are not calculated.

304.8 Shielding of storm shelters by host and adjacent buildings. *Storm shelters* enclosed in, partially enclosed in or adjacent to *host buildings* or adjacent to other buildings not designed **Use of this document constitutes your agreement to abide by the User Agreement located at the beginning of this document.**

for the load requirements of Chapter 3 shall be designed for wind loads considering the *host building* and adjacent buildings to be destroyed and the *storm shelter* to be fully exposed.

IS-STM 03-03-23 AM

304.9 Storm shelters connected to host buildings. Where **an a structural** element **or compo-**
nent of the *host building* is connected to a storm shelter, the storm shelter shall be designed to resist the maximum force that could be transmitted to the *storm shelter* equal to the ultimate failure strength of the connection or element being connected, whichever is lower, concurrent with the other wind loads on the *storm shelter* required by Chapter 3.

SECTION 305 DEBRIS HAZARDS

305.1 Wind-borne debris. All *storm shelters* shall be designed for the impact loads of wind-borne debris in accordance with Section 305.1.1 through 305.2.2.

305.1.1 Missile criteria for tornado shelters. The missile testing for all components of the *storm shelter envelope of tornado shelters* shall be a 15-pound (6.8 kg) sawn lumber 2 by 4 traveling at the speeds shown in Table 305.1.1.

IS-STM 03-02-23 AM

**TABLE 305.1.1
MISSILE SPEED FOR TORNADO SHELTERS**

DESIGN WIND TORNADO SPEED	MISSILE SPEED AND IMPACT SURFACE
130 mph	80 mph Vertical Surfaces 53 mph Horizontal Surfaces
160 mph	84 mph Vertical Surfaces 56 mph Horizontal Surfaces
200 mph	90 mph Vertical Surfaces 60 mph Horizontal Surfaces
250 mph	100 mph Vertical Surfaces 67 mph Horizontal Surfaces

For SI: 1 mile per hour = 0.447 m/s.

305.1.2 Missile criteria for hurricane shelters. The test missile for all components of the *storm shelter envelope of hurricane shelters* shall be a 9-pound (4.1 kg) sawn lumber 2 by 4. The speed of the test missile impacting vertical *storm shelter* surfaces shall be a minimum of 0.50 times the design wind speed. The speed of the test missile impacting horizontal surfaces shall be 0.10 times the design wind speed.

305.2 Testing for impacts. All components of the *storm shelter envelope* shall be tested for impact in accordance with Section 306 following the test procedures of Section 803.

Use of this document constitutes your agreement to abide by the User Agreement located at the beginning of this document.

Exception: Floors of the *storm shelter envelope* are not required to be tested for impact.

305.2.1 Inclined surfaces. *Storm shelter envelope* surfaces inclined 30 degrees (0.52 rad) or more from the horizontal shall be considered vertical surfaces. *Storm shelter envelope* surfaces inclined less than 30 degrees (0.52 rad) from the horizontal shall be considered horizontal surfaces.

IS-STM 03-04-23 AS

305.2.2 Soil-covered portions of storm shelters. Portions of soil-covered *storm shelters*, with less than 12 inches (305 mm) of soil cover protecting *storm shelter* horizontal surfaces, or with less than 36 inches (914 mm) of soil cover protecting *storm shelter* vertical surfaces, shall be tested for resistance to **missile perforation impact** as though the surfaces were exposed. To qualify for shielding from soil cover, the soil surfaces shall slope away from the entrance walls or other near-grade enclosure surfaces of underground *storm shelters* at a slope of not more than 2 inches per foot (**167 mm per meter**) for a horizontal distance of not less than 3 feet (914 mm) from the exposed portions of the *storm shelter* or unexposed portions deemed to be protected by soil cover. See Figure 305.2.2 for an example.

FIGURE 305.2.2 UNDERGROUND STORM SHELTER

305.3 Laydown and falling debris hazards. Where the roof of the *storm shelter* is within the laydown radius of a *laydown hazard* or the fall radius of a *falling debris hazard*, the *storm shelter* shall be designed to resist the impact loads from such hazards.

305.3.1 Laydown radius. The laydown radius shall be taken as the horizontal distance equal to the height of the *laydown hazard*.

305.3.2 Fall radius. The fall radius shall be taken as the horizontal distance equal to half the difference between the height of the *falling debris hazard* and the height of the roof of the *storm shelter* but need not exceed 30 feet (**9.1 m 9 144 mm**).

305.3.3 Impact loads. Impact loads from *laydown* and *falling debris hazards* shall be determined using a minimum impact factor of 2.0 times the estimated weight of the debris hazard. Each *laydown* and *falling debris hazard* load shall be considered one at a time, applied simultaneously with the uniform live loads on the roof of the shelter in accordance with Section 303.3.

SECTION 306 STORM SHELTER ENVELOPE COMPONENT DESIGN AND TESTING

IS-STM 03-02-23 AM

306.1 Storm shelters meeting tornado impact test requirements. *Storm shelter envelope* components meeting impact test requirements for *tornado shelters* at the 250 mph (**111.8 m/s**) design **wind tornado** speed in accordance with Section 305.1.1 shall be considered **acceptable** for the impact test requirements for *hurricane shelters* provided the components meet the structural design load requirements for *hurricane shelters*.

306.2 Fire-resistance rating. The *storm shelter envelope* shall be fire-resistance rated in accordance with Section 603 and the *applicable code*.

Use of this document constitutes your agreement to abide by the User Agreement located at the beginning of this document.

IS-STM 03-02-23 AM

306.3 Roof and wall assemblies. Roof and wall assemblies shall meet the impact criteria of Section 305.1, and the design tornado pressure and design wind pressure in accordance with Section 304.

IS-STM 03-05-23 AM

306.4 Roof and wall openings. All openings in the *storm shelter envelope* shall be protected in accordance with Sections 306.4.1 through 306.4.2 306.4.4, as applicable.

IS-STM 03-06-23 AM; IS-STM 03-02-23 AM

306.4.1 Impact-protective systems. *Impact-protective systems* for use in the *storm shelter envelope* shall be tested, listed and labeled for impact in accordance with Section 803 and static and cyclic pressure in accordance with Sections 804 and 805. Any changes to *listed impact-protective systems*, such as a change of glazing, shall require evaluation by the listing agency or retesting of the entire assembly.

Exceptions:

1. Window assemblies and other glazed openings where the opening is protected on the exterior side by an *impact-protective system* are not required to be tested for impact.
2. Window assemblies and other glazed openings where the opening is protected on the interior side by an *impact-protective system* are not required to be tested for impact and static and cyclic pressure.
3. Nonoperable, permanently affixed shields or cowlings designed to resist the design tornado pressure or design wind pressures are not required to be tested for static and cyclic pressure in accordance with Sections 804 and 805.

IS-STM 01-11-23 AM relocated

306.4.1.1 112.1 Listing and labeling. *Impact-protective systems* shall be *listed and labeled* denoting compliance with this standard.

IS-STM 03-02-23 AM; IS-STM 01-11-23 AM relocated

306.4.1.1.1 112.1.1 Marking. The following function and performance characteristics shall be provided on the *label* for each *impact-protective system* tested:

1. Manufacturer's identification reference or listing number for the assembly
2. Type of *impact-protective system*, such as window assembly, door assembly, shutter assembly or louver.
3. Hazard: hurricane, tornado or both.
4. Missile weight and speed.
5. Design tornado pressure, design wind pressure, or both.
6. Edition of ICC 500.

IS-STM 03-05-23 AM

306.4.1.1 306.4.1.4 Installation. *Impact-protective systems* shall be installed in accordance with the manufacturer's listing and installation instructions.

IS-STM 03-05-23 AM; IS-STM 03-06-23 AM; IS-STM 03-02-23 AM

Use of this document constitutes your agreement to abide by the User Agreement located at the beginning of this document.

306.4.1.2 306.4.1.3 Alternate anchorage Anchorage for impact-protective systems. Where anchorage of *impact-protective systems* to the *storm shelter* structure is required by means other than those provided in the manufacturer's *listed system listing in accordance with Section 112*, anchorage shall be designed for pull-out and shear to resist the *tornado and* wind loads in accordance with Section 304.

IS-STM 03-05-23 AM; IS-STM 03-09-23 AM

306.4.1.3 306.4.1.2 Impact-protective systems in tornado shelters. *Impact-protective systems in tornado shelters* shall be permanently affixed. All operable *impact-protective systems* shall include manual, nonpowered, *deployment* operation capabilities from inside the *storm shelter*.

IS-STM 03-05-23 AM; IS-STM 03-08-23 AM/AFM BC1

306.4.1.4 306.4.1.1 Door undercut. Door assemblies for use in the storm shelter envelope with a threshold at the level of exit discharge shall be limited to a 3/4-inch (19.1 mm) maximum, undercut. (See example in Figure **306.4.1.4 306.4.1.1**).

The gap at the meeting edge of a pair of side-swinging doors in the storm shelter envelope shall be 3/16-inch (4.8 mm) maximum.

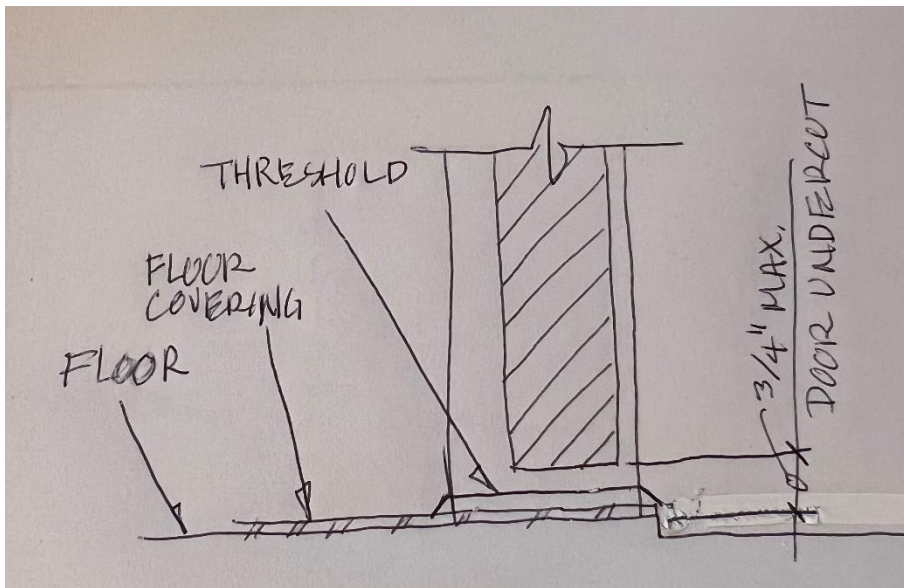

IS-STM 03-08-23 AM

Figure 306.4.1.4 306.4.1.1
Door undercut

From NFPA 80 – need new figure similar to this, but add threshold, change verbiage to match text.

IS-STM 03-10-23 AM

Use of this document constitutes your agreement to abide by the User Agreement located at the beginning of this document.

306.4.1.5 Louvers. Louvers shall be tested in accordance with Section 803.9.6 and shall be designed or configured such that debris particles shall impact at least two surfaces of the louver before passing through the *storm shelter envelope* and into the *protected occupant area*. Straight debris particle paths and elastic impacts are assumed in determining debris particle trajectories.

IS-STM 03-05-23 AM

306.4.2 Testing of alcove Alcove or baffled storm shelter entry systems. All protective elements of *alcove or baffled storm shelter entry systems* shall be tested for impact in accordance with Section 803.9.7.

IS-STM 03-05-23 AM (bottom half relocated to 701.3)

306.4.3 306.6 Penetrations of storm shelter envelope by mechanical, electrical and plumbing systems. Penetrations through the *storm shelter envelope* of mechanical, electrical and plumbing systems, including piping and utility lines, larger than 3¹/₂ square inches (2258 mm²) in area for rectangular penetrations or 2¹/₂ inches (64 mm) in diameter for circular penetrations, shall be considered openings and shall be protected in accordance with Section 306.4. Penetrations of the *storm shelter envelope* shall not degrade the structural integrity of the *storm shelter* and impact resistance of the *storm shelter envelope*.

Penetrations of the *storm shelter envelope* by hazardous gas or liquid lines shall have automatic shutoffs to protect against leakage due to movement of the utility line. The threshold movements for shutoff shall be as defined by the *applicable codes and standards governing such utility lines*.

IS-STM 03-05-23 AM; IS-STM 03-11-23 AM/AFM PC1

306.4.4 306.5 Joints, gaps or voids in storm shelter envelope. Joints, gaps or voids in a *storm shelter envelope* that ~~open~~ opens into the *protected occupant area* similar to masonry control joints, expansion joints, opening protective device shim spaces, air louver blades, grates, grilles, screens or precast panel joints shall be considered openings and shall be protected in accordance with Sections ~~306.4.1~~ 306.4 comply with the following:

Exceptions:

1. Masonry control joints and masonry or concrete expansion joints ³/₈-inch (9.5 mm) or less in width, sealed with joint material in accordance with TMS 602 for masonry or ASTM C920 for concrete.
2. Precast concrete panel joints in accordance with one of the following:
 - 2.1. For wall panels 6 inches (152 mm) in thickness or greater where the joint is a maximum of ³/₄ inches (19 mm) in width and sealed on each face with a Type S joint material in accordance ASTM C920. The panel thickness shall be measured perpendicular to the joint and at 1 inch (25 mm) or less from the joint center.
 - 2.2. For roof panels 4 inches (102 mm) in thickness or greater where the joint is a maximum of ³/₄ inches (19 mm) and sealed with a Type S joint material in accordance with ASTM C920. The panel thickness shall be measured perpendicular to the joint and at 1 inch (25 mm) or less from the joint center.
1. Joints, gaps ~~of~~ or voids shall be protected by permanent opening protection as *approved by the engineer of record and the authority having jurisdiction*.
- ~~2.3.~~ Joints, gaps or voids shall ~~that will~~ not allow a direct debris path through the *storm shelter envelope* into the *protected occupant area*. Debris particles shall impact at least

two surfaces meeting the impact criteria of Section 305.1 prior to arriving at the *protected occupant area*. Straight **missile debris particle** paths and elastic impacts are assumed in determining **missile debris particle** trajectories.

3. **Joints, gaps or voids that do not meet Item 1 or 2 shall comply with Section 306.4.1.4, 306.5.1 or 306.5.2.**

IS-STM 03-11-23 AM

306.5.1 Masonry control and expansion joints. Masonry control and expansion joints shall be a maximum of 1/2-inch (12.7 mm) in width and shall be sealed with joint material that complies with TMS 602 for masonry or ASTM C920 for concrete.

IS-STM 03-11-23 AM

306.5.2 Precast Concrete construction joints. Precast concrete panel joints shall comply with Section 306.5.2.1 or 306.5.2.2.

IS-STM 03-11-23 AM

306.5.2.1. Precast concrete wall panels. For wall panels 6 inches (152 mm) in thickness or greater, joints shall be a maximum of 3/4-inch (19 mm) in width and shall be sealed on each face with a Type S joint material that complies with ASTM C920. The panel thickness shall be measured perpendicular to the joint and at 1 inch (25 mm) or less from the joint center.

IS-STM 03-11-23 AM **errata – showed 306.5.2.1 twice instead of roof panels**

306.5.2.2 Precast concrete roof panels. For roof panels 4 inches (102 mm) in thickness or greater joints shall be a maximum of 3/4-inch (19 mm) in width and shall be sealed on each face with a Type S joint material in accordance with ASTM C920. The panel thickness shall be measured perpendicular to the joint and at 1 inch (25 mm) or less from the joint center.

SECTION 307 CONNECTION OF STORM SHELTERS TO FOUNDATIONS OR SLABS

307.1 Connections of storm shelters to foundations systems. *Storm shelters* shall be designed to resist all loads specified in Chapter 3 and to transfer the resultant forces from their point of origin through the structure to the foundation system. Foundation shall be designed to transmit the resulting loads to the supporting soil. Anchorage to concrete foundation systems shall be in accordance with ACI 318.

IS-STM 03-02-23 AM

307.1.1 Calculation of resistance. Structural stability of *storm shelters* shall be determined by engineering calculations for design **tornado and** wind loads. Where *storm shelters* are anchored to **foundations foundation** systems and such top surfaces extending outward from the *storm*

Use of this document constitutes your agreement to abide by the User Agreement located at the beginning of this document.

shelter walls are at grade, the top surfaces of the foundation systems shall not be considered to have wind uplift forces acting on them.

IS-STM 03-02-23 AM

307.1.2 Elevated storm shelter foundation systems. Where *storm shelters* are constructed with the top of the supporting foundation system located at an elevation higher than the surrounding finished grade level, the structural stability of the *storm shelter* and elevated supporting foundation system shall be computed assuming that both are fully exposed to the *storm shelter* design **tornado**, wind and flood loads. Where applicable, and in accordance with the *applicable code*, the impacts of flood-borne debris on stability of the foundation system shall be considered.

IS-STM 03-02-23 AM

307.2 Slabs-on-ground. Where slabs-on-ground are serving as part of the foundation system for the *storm shelter*, the slabs-on-ground shall be designed in accordance with ACI 318 to resist all loads specified in Chapter 3 and to transfer the resultant forces into the ground.

Exceptions:

1. Slabs-on-ground within a *storm shelter* not utilized to transfer **tornado and** wind forces acting on the *storm shelter* to the ground or to a foundation system supporting the storm shelter shall be designed in accordance with the *applicable code*.
2. Slabs-on-ground within a one- or two-family dwelling and supporting a *residential storm shelter* shall be designed in accordance with ACI 318 or ACI 332.

307.2.1 Joints in concrete slabs-on-ground. Design calculations for concrete slabs-on-ground shall include the effect of expansion joints, contraction joints or construction joints where such slabs-on-ground are utilized to resist loads from the supported *storm shelters*.

307.3 Existing slabs-on-ground supporting storm shelters. Replacement or strengthening of existing slabs-on-ground where a *storm shelter* is to be installed shall not be required where all of the following conditions apply:

1. *Community storm shelters* that are a single story in height with a footprint of 64 square feet (5.95 m²) or less or *residential storm shelters*.
2. The *storm shelter* is constructed out of concrete or concrete masonry.
3. Calculated soil pressure under the slabs-on-ground supporting the *storm shelter* walls does not exceed 2,000 psf (95.8 kN/m²) for design loading conditions other than design storm events and 3,000 psf (143.7 kN/m²) for design storm events.
4. The *storm shelter* is anchored at a minimum to the slab-on-ground at each corner of the structure and on each side of door openings in the shelter envelope.

CHAPTER 4

SITING

SECTION 401 GENERAL

401.1 Scope. The requirements of this chapter shall govern the siting, elevation and travel distance for *storm shelters*.

SECTION 402 FLOOD CRITERIA

402.1 General. Flood criteria shall apply to *storm shelters* in accordance with Table 402.1. *Storm shelters* shall be sited and elevated in accordance with Sections 402.2 through 402.6.4 and shall be designed and constructed to resist the effects of flood hazards and flood loads in accordance with Section 303.5.

**TABLE 402.1
STORM SHELTERS REQUIRED TO COMPLY WITH SECTION 402**

Type of Shelter	Location of Shelter		
	Flood hazard area	500-year flood hazard area	Storm surge flood hazard area
Community tornado shelter	All	Risk Category IV facilities or serving Risk Category IV facilities ^a	NA
Community hurricane shelter	All	All	All
Residential tornado shelter	All	NA	NA
Residential hurricane shelter	All	All ^b	All

NA = not applicable

- a. Risk categories are determined in accordance with Table 1604.5 of the *International Building Code*.
- b. Where the *500-year flood hazard area* is mapped and the *500-year flood elevation* is available in the *flood elevation study* adopted by the *authority having jurisdiction*.

402.2 Design criteria. The design and construction of *storm shelters* or portions thereof located in the areas indicated in Table 402.1, including *coastal high-hazard areas* and *coastal A zones* shall be in accordance with the provisions of this chapter, and ASCE 24 except for the floor elevations for *storm shelters* required in Section 402.6.

Use of this document constitutes your agreement to abide by the User Agreement located at the beginning of this document.

402.3 Determining flood elevations and floodway. The *flood elevation* and floodway shall be determined using the flood hazard map adopted by the applicable governing authority. Where *flood elevations* and floodway are not included in the flood hazard map, or where a *flood elevation study* is not adopted by the applicable governing authority, the *flood elevation* and floodway shall be determined in accordance with one of the following:

1. Utilize a *flood elevation* and floodway data available from federal, state or other *approved* source.
2. Determine the flood elevation and floodway in accordance with the accepted hydrologic and hydraulic engineering practices used to prepare a *flood elevation study*. Determination shall be undertaken by a registered design professional who shall document that the technical methods used reflect currently accepted engineering practice.

402.4 Flood information. Flood information shall be provided on the construction documents in accordance with Section 106.2.1.

402.5 Storm shelter siting. *Storm shelters* shall be located outside of the following high-risk areas:

1. *Coastal high-hazard areas* and *coastal A zones*.
2. Floodways.

Exception: *Storm shelters* shall be permitted in *coastal high-hazard areas* and *coastal A zones* where permitted by the Board of Appeals in accordance with the provisions of the *International Building Code* or *International Residential Code*.

402.6 Minimum floor elevation of storm shelters. Where *storm shelters* are located in the areas indicated in Table 402.1, the minimum floor elevations of *storm shelters* shall be determined in accordance with Sections 402.6.1, 402.6.2, 402.6.3 and 402.6.4, as applicable.

402.6.1 Minimum floor elevation of community tornado shelters. The lowest floor used for the *occupied storm shelter areas* and *occupant support areas* of a *community tornado shelter* shall be elevated to or above the highest of the elevations determined by all of the following:

- 1.–The minimum elevation of the lowest floor required by the *authority having jurisdiction*.
- 2.–One foot (305 mm) above the *base flood elevation*.
- 3.–For *storm shelters* that are Risk Category IV facilities or serving Risk Category IV facilities:
 - 3.1. The *500-year flood elevation*.
 - 3.2. Two feet (~~664~~ 610 mm) above the *base flood elevation*.

Exceptions:

1. A *community tornado shelter* is not required to be elevated to the level required by Items 1 through 3, where all of the following are met:
 - 1.1. The *storm shelter* is completely within a *host building* that is dry floodproofed in accordance with ASCE 24 to the elevation prescribed in Items 1 through 3; or the *storm shelter* is dry floodproofed in accordance with ASCE 24 to the elevation prescribed in Items 1 through 3.
 - 1.2. The *storm shelter* has at least one door, emergency escape opening or hatch complying with Chapter 5 that has the bottom of the opening located above the dry floodproofing elevation.

1.3. The elevation of the floor of the *storm shelter* is not more than 36 inches (914 mm) below the elevation required by Items 1 through 3.

2. Where a *community tornado shelter* is constructed within an existing *host building*, only Item 1 shall apply.

402.6.2 Minimum floor elevation of community hurricane shelters. The lowest floor used for the *occupied storm shelter areas* and *occupant support areas* of a *community hurricane shelter* shall be elevated to or above the highest of the elevations determined by all of the following:

1. The minimum elevation of the lowest floor required by the *authority having jurisdiction*.
2. Two feet (610 mm) above the *base flood elevation*.
- 3.–The *500-year flood elevation*.
- 4.–The *storm surge flood elevation*

402.6.3 Minimum floor elevation of residential tornado shelters. The lowest floor of a *residential tornado shelter* shall be elevated to or above the highest of the elevations determined by all of the following:

1. The minimum elevation of the lowest floor required by the *authority having jurisdiction*.
2. One foot (305 mm) above the *base flood elevation*.

Exception: Where a *residential tornado shelter* is constructed within an existing *host building*, only Item 1 shall apply.

402.6.4 Minimum floor elevation of residential hurricane shelters. The lowest floor of a *residential hurricane shelter* shall be elevated to or above the highest of the elevations determined by all of the following:

- 1.–The minimum elevation of the lowest floor required by the *authority having jurisdiction*.
2. The *500-year flood elevation*.
3. The *storm surge flood elevation*.

SECTION 403 MAXIMUM TRAVEL DISTANCE FOR TORNADO SHELTERS

403.1 Community tornado shelters in educational occupancies. Where required by the *International Building Code*, *community tornado shelters* that serve educational occupancies shall comply with the maximum travel distance to the tornado shelter entrance.

403.2 Residential tornado shelters. *Residential tornado shelters* shall be located within the residence that the shelter is intended to serve, or shall be located on the site such that the maximum travel distance of at least one travel path from an access opening on the shelter to an exterior door of any residences that the shelter is intended to serve does not exceed 150 feet (45 720 mm).

CHAPTER 5

IS-STM 05-01-23 AS; IS-STM 05-06-23 AM

OCCUPANCY OCCUPANT DENSITY, ACCESS ENTRY, ACCESSIBILITY, EGRESS AND SIGNAGE

SECTION 501 GENERAL

IS-STM 05-06-23 AM

501.1 Scope. The requirements of this chapter shall govern the occupant density, ~~access~~, accessibility, ~~entry~~, egress and signage for *storm shelters*.

IS-STM 05-01-23 AS

SECTION 502 OCCUPANCY OCCUPANT DENSITY IN COMMUNITY STORM SHELTERS

502.1 General. A *community storm shelter* shall comply with the requirements of Sections 502.2 through 502.4.

502.2 Design occupant capacity. The *design occupant capacity* served by the storm shelter shall be assigned or calculated in accordance with Section 502.2.1 or 502.2.2.

IS-STM 05-02-23 AS

502.2.1 Assigned. The assigned *design occupant capacity* shall be ~~based on the design occupant capacity of the storm shelter, as~~ determined by the designer and the owner or the owner's authorized agent, and *approved by the authority having jurisdiction*.

IS-STM 05-02-23 AS

502.2.2 Calculated. The calculated *design occupant capacity* shall be determined by the *usable floor area* divided by the ~~unit of area prescribed per~~ occupant density in Table 502.3.

IS-STM 05-02-23 AS; IS-STM 05-03-23 AM – Reconsideration for coordination

502.3 Required usable floor area. For *community storm shelters*, the minimum required *usable floor area per occupant* shall be computed at the rate of one occupant per unit of area prescribed ~~in~~ shall be in accordance with Table 502.3.

~~Each storm shelter shall be sized to accommodate a minimum of one wheelchair space for every 200 storm shelter occupants or portion thereof.~~

IS-STM 05-03-23 AM

502.3.1 Type of occupants. The number of occupants who are standing, seated, use a wheelchair, or are relocated in a bed or stretcher shall be determined based upon the needs of the intended shelter occupants.

IS-STM 05-03-23 AM

502.3.2 Wheelchair spaces. Each storm shelter shall be sized to accommodate a minimum of one wheelchair space for every 200 storm shelter occupants or portion thereof.

**TABLE 502.3
OCCUPANT DENSITY—COMMUNITY STORM SHELTERS**

TYPE OF OCCUPANTS	MINIMUM REQUIRED USABLE FLOOR AREA IN SQUARE FEET PER OCCUPANT
Tornado	
Occupants who are standing or seated	5
Occupants using a wheelchair	10
Occupants who are relocated in a bed or stretcher	30
Hurricane	
Occupants who are standing or seated	20
Occupants using a wheelchair	20
Occupants who are relocated in a bed or stretcher	40

IS-STM 05-04-23 AS

502.4 Provided usable floor area. The *usable floor area* provided shall be determined by Section 502.4.1, 502.4.2 or a combination of these methods. The *usable floor area* provided shall meet or exceed required *usable floor area* determined in Section 502.3. Useable floor areas shall not include storm shelter occupant support areas.

Exception: In community tornado shelters, the following occupant support areas shall be permitted to be considered usable floor area:

1. A single occupant toilet room area that is the entire shelter.
2. Multi-stall toilet rooms, not including the toilet stalls and temporary water closet privacy areas.

502.4.1 Calculation of usable floor area. The *usable floor area* shall be determined by using the following percentages:

1. Reducing the gross floor area of *storm shelter* areas with *areas of concentrated furnishings* or fixed seating by a minimum of 50 percent.
2. Reducing the gross floor area of *storm shelter* areas with *areas of unconcentrated furnishings* and without fixed seating by a minimum of 35 percent.
3. Reducing the gross floor area of *storm shelter* areas with *areas of open plan furnishings* and without fixed seating by a minimum of 15 percent.

Use of this document constitutes your agreement to abide by the User Agreement located at the beginning of this document.

502.4.2 Alternative calculation of usable floor area. The *usable floor area* shall be determined by subtracting from the gross floor area, the floor area of partitions and walls, columns, fixed or movable objects, furniture, equipment or other features that under probable conditions cannot be removed.

IS-STM 05-04-23 AS

502.5 Tornado shelter usable floor area. In *community tornado shelters*, the following *occupant support areas* shall be permitted to be considered *usable floor area*:

1. The *entire storm shelter* is a single occupant toilet room area.
2. The *storm shelter* includes multi-stall toilet rooms, the toilet room area other than the toilet stalls and temporary water closet privacy areas.

**SECTION 503
OCCUPANT DENSITY IN RESIDENTIAL STORM SHELTERS**

503.1 General. A *residential storm shelter* shall comply with the requirements of Sections 503.2 through 503.3.

IS-STM 05-02-23 AS; IS-STM 05-03-23 AM – Reconsideration for coordination

503.2 Required usable floor area. For *residential storm shelters*, the minimum required *usable floor area* shall be computed at the rate of one per occupant per unit of area prescribed shall be in accordance with ~~in~~ Table 503.2.

**TABLE 503.2
OCCUPANT DENSITY—RESIDENTIAL STORM SHELTERS**

TYPE OF OCCUPANTS	MINIMUM REQUIRED USABLE FLOOR AREA IN SQUARE FEET PER OCCUPANT
Tornado	
One- and two-family dwelling	3
Other residential	5
Hurricane	
One- and two-family dwelling	7
Other residential	10

For SI: 1 square foot = 0.0929 m².

503.3 Provided usable floor area. The *usable floor area* provided shall be determined by subtracting from the gross floor area, the floor area of partitions and walls, columns, fixed or movable objects, furniture, equipment or other features that under probable conditions cannot be removed. The *usable floor area* provided shall meet or exceed the required *usable floor area* determined in Section 503.2.

IS-STM 05-06-23 AM

Use of this document constitutes your agreement to abide by the User Agreement located at the beginning of this document.

SECTION 504
ACCESS ENTRY AND EGRESS IN COMMUNITY STORM SHELTERS

IS-STM 05-06-23 AM

504.1 General. A *community storm shelter* shall comply with the **access entry** and egress requirements of Sections 504.2 through ~~504.6~~ **504.7.** ~~Community storm shelters shall also comply with Section 603, as applicable.~~

IS-STM 05-06-23 AM

504.2 ~~504.3~~ **Accessibility.** Buildings and space used as *community storm shelters* shall be accessible **for persons with disabilities** in accordance with the *applicable code*.

IS-STM 05-06-23 AM

~~504.3~~ ~~504.2~~ **Wall and roof Entry and egress openings.** All **access entry and egress** openings, means of egress doors, emergency escape openings and overhead hatches in the *storm shelter envelope* shall be considered openings and shall be protected in accordance with Section 306.4. **Such openings shall also comply with the requirements in Section 402.6.1 and 603, as applicable.**

IS-STM 05-06-23 AM

504.4 Egress doors. The means of egress doors in the *storm shelter envelope* shall be determined based upon the occupant load for the normal occupancy of the space in accordance with the *applicable code*. ~~The number of doors shall also comply with Section 603.~~

Where the *applicable code* requires only one means of egress door from the *storm shelter*, the storm shelter shall also provide an emergency escape opening **in accordance with Section 504.5** **or** an overhead hatch **accessed by an emergency stair, ladder or alternating tread device in accordance with Section 506.**

Exception: *Storm shelters* having a *design occupant capacity* not exceeding 16 are not required to provide an emergency escape opening or an overhead hatch.

IS-STM 05-06-23 AM

504.5 Emergency escape opening. ~~The emergency~~ **Emergency** escape **opening openings** shall be an additional door or an opening that complies with the following:

1. Has a minimum net clear opening of 5.7 square feet (0.530 m²).
2. Has a minimum net clear opening height of 24 inches (610 mm) and a minimum net clear opening width of 20 inches (508 mm).
3. Shall be operable from the inside without the use of tools or special knowledge.
4. Where the bottom of the clear opening is located more than 44 inches (1118 mm) above the floor, vertical access to the opening shall be provided by an emergency stair, **complying with Section 506.2 or** a ladder **complying with Section 506.3,** or an alternating tread device complying with Section ~~506.4~~ **506.**
5. **To decrease the probability of both the emergency escape opening and the egress door being blocked by debris comply with the following:**

5.1. Where practicable, the emergency escape opening shall be located on an opposite wall, perpendicular wall, roof, or floor of the shelter envelope from the means of egress door.

5.2. The emergency escape opening shall be separated from the means of egress door by a distance not less than 1/3 of the overall diagonal dimension of the storm shelter. The distance shall be measured horizontally in a straight line between any point along the openings.

Exception: The minimum net clear opening shall be permitted to be 5 square feet (0.46 m²) where the bottom of the emergency escape opening is not more than 44 inches (1118 mm) above or below finished grade.

IS-STM 05-06-21 AM

504.5.1 Area Wells. Where provided, area wells at emergency escape openings shall comply with the International Building Code, Section 1031.5.

IS-STM 05-06-23 AM

504.6 ~~506.5~~ Overhead hatches. Where provided, overhead hatches at the tops of emergency stairs, ladders or alternating tread devices shall comply with the following:

1. A minimum clear dimension of 24 inches by 30 inches (610 mm by 762 mm).
2. A clear opening of 24 inches (610 mm) minimum from the face of the top tread or rung of the emergency stairs, ladders or alternating tread devices on the climbing side of the emergency stairs, ladders or alternating tread devices.
3. A minimum of 15 inches (372 mm) on either side of the centerline of the top tread or rungs.
4. Where the access opening is located on a vertical surface in accordance with Section 305.2, the height of the opening shall be 30 inches (762 mm) minimum.
5. **Overhead hatches** ~~Hatches~~ shall open a minimum of 60 degrees (1.04 rad) from the closed position.
6. **Overhead hatches** ~~Hatches~~ shall be counterweighted or otherwise held in the open position when opened.
7. Vertical access to the overhead hatch shall be provided by an emergency stair, a ladder or an alternating tread device complying with Section 506.
8. To decrease the probability of both the overhead hatch and the egress door being blocked by debris comply with the following:
 - 8.1. Where practicable, the overhead hatch shall be located on an opposite wall, perpendicular wall, roof, or floor of the shelter envelope from the means of egress door.
 - 8.2. The overhead hatch shall be separated from the means of egress door by a distance not less than 1/3 of the overall diagonal dimension of the storm shelter. The distance shall be measured horizontally in a straight line between any point along the openings.

IS-STM 05-06-23 AM - modification replace by

IS-STM 05-07-23 AM/05-08-23 AM/05-09-23 AM/D for Section 504.6

504.7 ~~504.6~~ Multistory shelter. Storm shelters with multiple stories shall be required to have one emergency means of vertical access and egress provided within the storm shelter to a level of exit discharge provided by an emergency stair complying with Section 506.2 or a ladder complying with Section 506.3, or an alternating tread device complying with Section 506.4.

Use of this document constitutes your agreement to abide by the User Agreement located at the beginning of this document.

Exception: Provide an emergency escape opening or overhead hatch to allow for emergency vertical access and egress to the roof.

05-09-23 AM/D for Section 504.6

~~504.7~~ **504.6 Vertical Access Within the Storm Shelter.** All storm shelter occupants shall have vertical access within the *storm shelter* to the level of exit discharge or to the roof of the *storm shelter*. Vertical access within the *storm shelter* shall be provided by a stairway, or by an emergency stair, ladder or alternating tread device complying with Section 506.

Exception: *Storm shelters* having a design occupant capacity not exceeding 16 are not required to provide vertical access within the *storm shelter*.

IS-STM 05-06-23 AM

SECTION 505

ACCESS ENTRY AND EGRESS IN RESIDENTIAL STORM SHELTERS

IS-STM 05-06-23 AM

505.1 General. A residential storm shelter shall comply with the **access entry** and egress requirements of Sections 505.2 through 505.4.

IS-STM 05-06-23 AM

505.2 Wall and roof openings. All **access entry** and egress openings, **and** means of egress doors ~~and overhead hatches~~ in the *storm shelter envelope* shall be considered openings and shall be protected in accordance with Section 306.4.

IS-STM 05-06-23 AM

505.3 Access Entry and egress. A residential storm shelter shall be provided with a method of **access entry** and egress by a means of egress door, **or** an **access entry** and egress opening **with** a clear opening of 24 inches by 30 inches (610 mm by 762 mm) minimum ~~complying with Section 505.3.1 or an overhead hatch complying with Section 506.5.~~

IS-STM 05-06-23 AM

505.3.1 Access and egress openings. Access and egress openings shall have a clear opening of 24 inches by 30 inches (610 mm by 762 mm) minimum.

IS-STM 05-06-23 AM

505.4 Vertical access and egress. Where provided, vertical access **and egress** to **a-an entry and egress opening in** a residential storm shelter shall be by an emergency stair ~~complying with Section 506.2, or by a ladder complying with Section 506.3,~~ or an alternating tread device complying with Section ~~506.4~~ **506.**

IS-STM 05-06-23 AM

SECTION 506

Use of this document constitutes your agreement to abide by the User Agreement located at the beginning of this document.

VERTICAL ACCESS AND EGRESS

IS-STM 05-06-23 AM

506.1 General. ~~Where stairways are~~ **Stairways** required for means of egress for normal use of the space, ~~they~~ shall comply with the *applicable code*. **Vertical access for emergency egress shall be provided by an** ~~An~~ emergency stair ~~shall comply~~ **complying** with Section 506.2.; ~~A~~ **a** ladder shall ~~comply~~ **complying** with Section 506.3-~~or An an~~ alternating tread device shall ~~shall comply~~ **complying** Section 506.4. ~~Overhead hatches shall comply with Section 506.5.~~

506.2 Emergency stairs. Emergency stairs shall comply with all of the following:

1. Treads shall have a minimum depth of 8 inches (203 mm).
2. Treads shall not be required to have a nosing.
3. Surfaces or treads shall be slip resistant.
4. The maximum height of risers shall be 9 ⁹/₁₆ inches (243 mm).
5. The minimum width of the emergency stairs shall be 22 inches (559 mm).
6. The angle of the emergency stair from horizontal shall be a maximum of 50 degrees (0.87 rad).

Exception: For *residential storm shelters*, which have a rise between the *storm shelter* floor level and *storm shelter entrance* level of 70 inches (1778 mm), maximum, the maximum height of risers shall be 10 inches (254 mm).

506.2.1 Headroom. The minimum headroom clearance shall be 80 inches (2032 mm), measured vertically from a line connecting the edge of the nosing.

Exceptions:

1. The minimum headroom clearance is permitted to be reduced to 60 inches (1524 mm) where signage is provided at the top and bottom of the emergency stair conspicuously warning the user of low headroom.
2. Entrances that are entered by persons seated on the entrance threshold and that are not high enough for a person to enter standing erect shall not be required to provide minimum headroom clearance provided there is no more than two risers leading into the *storm shelter*.

506.2.2 Handrails. A continuous handrail shall be located on one side of an emergency stair having more than three risers. Handrail extensions are not required.

IS-STM 05-06-23 AM

506.3 Ladders. Ladders shall comply with the all of the following:

1. The clear width between rails shall be not less than 16 inches (406 mm).
2. Rungs shall be a minimum of ³/₄-inch (19 mm) in diameter.
3. Rungs or treads shall be capable of withstanding a 300 pound (136 kg) load.
4. Rungs or treads shall be spaced uniformly at not greater than 12 inches (305 mm).
5. The minimum clearance between the centerline of the rungs or treads to the nearest permanent object in back of the ladder on the toe side shall be no less than 7 inches (178 mm).

Use of this document constitutes your agreement to abide by the User Agreement located at the beginning of this document.

6. Ladders shall have a maximum slope of 90 degrees (1.57 rad) from horizontal and a minimum slope of 75 degrees (1.31 rad) from horizontal where measured on the toe side of the ladder.

7. Ladders shall have a minimum of 15 inches (381 mm) clear on either side of the centerline of the ladder and a minimum of 27 inches (686 mm) clear from the centerline of the rungs to an obstruction on the climbing side of the ladder.

Exception: A minimum clearance is not required on the back side of the ladder where there is no obstruction on the climbing side of the ladder, and where ladder treads of 11 inches (279 mm) or greater in depth are molded or fabricated in a continuous series of treads and risers as detailed in Figure 506.3.

FIGURE 506.3 ALTERNATIVE FOR A LADDER IN A STORM SHELTER

IS-STM 05-06-23 AM

506.3.1 Ladder wells. Ladder wells where provided shall have a minimum of 15 inches (381 mm) clear on either side of the centerline of the ladder and a minimum of 27 inches (686 mm) clear from the centerline of the rungs to a ladder well or obstruction on the climbing side of the ladder.

506.4 Alternating tread devices. Alternating tread devices shall comply with the applicable requirements listed in the *applicable code*.

IS-STM 05-06-23 AM relocated

504.6 506.5 Overhead hatches.

SECTION 507 LATCHING

IS-STM 05-10-23 AM

507.1 General. Latching shall comply with the requirements of Sections 507.2 through **507.6 507.4.**

507.2 507.1 Latching mechanisms. Latching mechanisms for *impact-protective systems* shall be permanently mounted on the assembly. Such mechanisms shall require no tools to be engaged in the latched position. Devices such as pins shall be permanently secured to the assembly through the use of chains or wires that must be of corrosion-resistant material.

Latching mechanisms necessary for *impact-protective systems* to perform as designed for the *storm shelter* shall comply with either of the following:

1. Automatically engage where the *impact-protective systems* ~~is~~ are in a closed position and shall not be capable of being disabled.
2. Be capable of being engaged by an occupant. Signage shall be provided with instructions for latching the *impact-protective systems* for *storm shelter* use.

Use of this document constitutes your agreement to abide by the User Agreement located at the beginning of this document.

507.3 507.2 Multi-latching systems. *Impact-protective systems* utilizing multi-latching systems with more than one single-action latching mechanism shall be provided with permanently posted instructions on the latching.

IS-STM 05-11-23 AM errata

507.4 507.3 Operating hardware on the unprotected side. ~~Where operating~~ **Operating** hardware of an *impact-protective system* ~~is~~ located on the unprotected side of the *storm shelter envelope*, shall not be susceptible to unlatching by debris impact. ~~after~~ **After** the latching mechanism is engaged in accordance with Section 507.1, such operating hardware on the ~~non-egress unprotected~~ side shall be locked, disabled, or inactive ~~and shall not be susceptible to unintentional unlatching by debris impact.~~

IS-STM 05-12-23 AM

507.5 507.4 Electronic operating hardware. Where an *impact-protective system's* closing, latching, or locking, is electronically controlled, shelter occupants shall have the ability to secure the *impact-protective system* from within the shelter.

IS-STM 05-13-23 AM

507.6 507.5 Egress. Latching or locking mechanisms for *impact-protective systems* that protect openings required for egress, shall not prohibit egress out of the storm shelter.

SECTION 508 SIGNAGE

IS-STM 05-14-23 AM

508.1 Signage requirements. All *storm shelters* shall be marked with design information in accordance with Section 508.2. *Community storm shelter* areas shall be marked by signage in accordance with Sections 508.3 through ~~508.5 508.7~~, as applicable. ~~All signs~~ **Signs required by Sections 508.3 through 508.5 508.7** shall comply with the visual character requirements of ICC A117.1.

IS-STM 05-16-23 AS; IS-STM 03-02-23 AM/AFM BC4

508.2 Design information signage. All *storm shelters* shall have a sign on or within the *storm shelter* with all of the following:

1. ~~The design~~ **Design** occupant capacity.
2. ~~The storm~~ **Storm** type.
3. ~~The design~~ **Design** ~~tornado speed, design~~ wind speed **or both**.
4. ~~The edition~~ **Edition** of the ICC 500 used for the design.
5. ~~The name~~ **Name** of the manufacturer or builder of the *storm shelter*.

IS-STM 05-17-23 AM

Use of this document constitutes your agreement to abide by the User Agreement located at the beginning of this document.

508.3 Directional Signage. The path of travel to the storm shelter shall be clearly marked with direction signage to direct intended occupants to the storm shelter.

IS-STM 05-17-23 AM

508.3 508.3.1 Exterior directional signage. Where the storm shelter serves the general public, exterior directional signage ~~is required~~ shall be provided to direct intended occupants to the storm shelter.

IS-STM 05-17-23 AM

508.4 508.3.2 Directional signage for a multibuilding site. Where a storm shelter serves multiple buildings, directional signage shall be provided at or within the buildings served by ~~to direct intended occupants to~~ the storm shelter.

IS-STM 05-17-23 AM

508.3.3 Host building directional signage. Directional signage shall be provided within the *host building* in cases where the path of travel is not readily apparent.

IS-STM 05-17-23 AM

508.5 Directional signage within a host building. Where a *storm shelter* is within a *host building*, directional signage is required within the host building to direct intended occupants to the *storm shelter*. The path of travel to the *storm shelter* shall be clearly marked to indicate the direction of travel in cases where the path of travel is not immediately visible to the intended occupants.

IS-STM 05-18-23 AS; IS-STM 05-06-23 AM

508.4 508.6 Entry signage. Signage indicating "Tornado Shelter," or "Hurricane Shelter," or "Hurricane and Tornado Shelter", and appropriate symbols as applicable, shall be installed on the outside of the *storm shelter*, adjacent to every **access entry** opening intended to provide entry for occupants into the *storm shelter*.

IS-STM 05-06-23 AM

508.5 508.7 Perimeter signage. Signs shall be installed inside of the *storm shelter* adjacent to every **access entry** or egress opening, which access nonprotected areas located outside of the *storm shelter*. For example, signage indicating "Notice: Now leaving the Tornado Shelter," or "Notice: Now leaving the Hurricane Shelter."

CHAPTER 6

FIRE SAFETY

SECTION 601 GENERAL

601.1 Scope. The requirements of this chapter shall govern the fire safety of *community storm shelters*.

SECTION 602 FIRE PROTECTION SYSTEMS

IS-STM 03-02-23 AM

602.1 Fire protection system. Fire protection systems shall be provided within the *storm shelter* where required by the *applicable code* for the normal use of the space. These systems are not required to remain functional for the design storm event and minimum period of shelter occupancy (24 hours for *hurricane shelters*, 2 hours for *tornado shelters*) or to be protected from the **tornado** and wind load and impact requirements of Chapter 3 or the flood-resistance requirements of Chapter 4.

SECTION 603 FIRE-RESISTANCE RATED CONSTRUCTION

IS-STM 06-01-23 AM; IS-STM 06-02-23 AS; IS-STM 06-04-23 AS

603.1 Fire separation. Walls **or and** *horizontal assemblies* between *community storm shelters* and **other** *host building* areas shall be *fire barriers* or *horizontal assemblies* with a minimum fire-resistance rating of 2 hours constructed in accordance with the *applicable code*.

Exceptions: Walls and *horizontal assemblies* are not required to be fire-resistance rated with any of the following configurations:

1. **The design** **Design** *occupant capacity* of 16 or fewer.
2. **The storm** **Storm** *shelter* is located in the basement or underground, the *design occupant capacity* is less than 50, at least two egress doors are provided and the egress doors are separated by a minimum horizontal distance equal to one-third of the overall diagonal dimension of the *storm shelter*.
3. **The design** **Design** *occupant capacity* is less than 50 and an **additional** egress door, overhead hatch or emergency escape opening opens directly to the exterior of the building.
4. **The means** **Means** of egress is designed in accordance with the *applicable code* for the *design occupant capacity*, the *storm shelter* has at least two egress doors and at least 50 percent of the total required capacity for the means of egress from the *storm shelter* is directly to the exterior of the building.

IS-STM 06-07-23 AS

603.1.1 Doors and shutters. ~~Fire doors and shutters in~~ In fire barriers required solely for compliance with Section 603.1, fire doors and shutters shall not be required to be self- or automatic-closing.

SECTION 604 FIRE EXTINGUISHERS

604.1 General. A fire extinguisher shall be required within each story of all *community storm shelters*.

IS-STM 06-08-23 AM; IS-STM 06-09-23 AS

604.2 Requirements. Fire extinguishers shall ~~meet the requirements of NFPA 10~~ be provided in accordance with the International Building Code Section 906. Installation of fire extinguishers shall not compromise the structural or missile impact performance of the exterior *storm shelter envelope*.

CHAPTER 7

IS-STM 07-01-23 AS

~~STORM SHELTER~~ ESSENTIAL FEATURES AND ACCESSORIES

SECTION 701 GENERAL

701.1 Scope. The requirements of this chapter shall govern the essential features and accessories for *storm shelters*.

IS-STM 03-02-23 AM; IS-STM 07-02-23 AS relocated to 702.2 and 703.2

~~**701.2 Protection of storm shelter critical support systems.** *Storm shelter critical support systems* shall remain functional for the design storm event and minimum period of *storm shelter occupancy* (24 hours for hurricane shelters, 2 hours for tornado shelters). *Storm shelter critical support systems* located outside of the *storm shelter* areas shall be protected by a means that meets the tornado and wind load and impact requirements of Chapter 3, and, as applicable, the flood-resistance requirements of Chapter 4.~~

IS-STM 03-05-23 AM (relocated part of 306.6)

701.2 701.3 Shutoffs at penetrations. Hazardous gas or liquid lines penetrating the *storm shelter envelope* shall have automatic shutoffs to protect against leakage due to movement of the utility line. The threshold movements for shutoff shall be as defined by the *applicable codes and standards governing such utility lines*.

SECTION 702 TORNADO SHELTERS

IS-STM 07-02-23

702.1 General. *Tornado shelters* shall comply with the requirements of Sections 702.2 through ~~702.9~~ 702.10.

IS-STM 03-02-23 AM; IS-STM 07-02-23 AS/AFM BC1

~~**702.2 701.2** Protection of tornado storm shelter critical support systems. Storm Tornado shelter critical support systems shall remain functional for the design storm event and a minimum period of two hours storm shelter occupancy (24 hours for hurricane shelters, 2 hours for tornado shelters). Storm Tornado shelter critical support systems located outside of the storm tornado shelter areas shall be protected by a means that meets the tornado and wind load and impact requirements of Chapter 3, and, as applicable, the flood-resistance requirements of Chapter 4.~~

Use of this document constitutes your agreement to abide by the User Agreement located at the beginning of this document.

Exception: The water supply system and waste water system for water closets and lavatories are not required to comply with this section.

702.3 702.2 Exterior weather protection. All exposed components and cladding assemblies and roof coverings of *tornado shelters* shall meet the requirements of the *applicable code*.

702.3.1 702.2.4 Door weather seal. Doors in the shelter envelope that are also exterior doors to the building shall have a weather seal provided at the undercut.

IS-STM 07-03-23 AS

702.4 702.3 702.3.1 Water closets and lavatories. Water closets and lavatories shall be either permanent plumbing fixtures installed within the *tornado shelter*, or temporary water closets, *such as chemical toilets*, or *temporary lavatories, such as chemical toilets such as portable hand washing stations*, or other means *approved by the authority having jurisdiction*.

IS-STM 07-03-23 AS

702.4.1 702.3.1 702.3 Minimum number water closets and lavatories. Water closets and lavatories shall be located within the *tornado shelter* and provided in the minimum number indicated in Table **702.4.1 702.3.1 702.3**.

IS-STM 07-03-23 AS

**TABLE 702.4.1 702.3.1 702.3
REQUIRED WATER CLOSET AND LAVATORIES
FOR TORNADO SHELTERS**

TORNADO SHELTER TYPE	WATER CLOSETS	LAVATORIES
Residential, one- and two-family dwellings	Not Required	Not Required
Residential, other	1	Not Required
Community, <i>design occupant capacity < 50</i>	1	Not Required
Community, <i>design occupant capacity >= 50</i>	1 per 250 for the first 500 occupants and 1 additional per 500 occupants or portions thereof > 500 occupants	1 per 1,000 occupants

702.4.2 702.3.2 Water closet and lavatory calculations. The number of water closets and lavatories shall be allocated in accordance with the *International Plumbing Code*®.

702.4.2.1 702.3.2.1 Urinals. Urinals shall be permitted to be substituted for water closets in accordance with the *International Plumbing Code*.

Use of this document constitutes your agreement to abide by the User Agreement located at the beginning of this document.

IS-STM 05-05-23 AM

702.4.3 702.3.3 Water closet privacy. Each water closet shall occupy a separate **compartment area within the room** with **compartment** walls, partitions, curtains or equivalent that enclose the water closet to ensure privacy.

IS-STM 07-02-23 AS/AFM BC1

702.4.4 Sanitation support method. A sanitation support method for the water closets or lavatories shall be capable of supplying water and containing waste for the *design occupant capacity* of the *tornado shelter*.

IS-STM 07-02-23 AS/AFM BC1

702.4.4.1 Storage capacity for water supply and wastewater. In community shelters with a *design occupant capacity* of 50 or greater, the capacity of the plumbing and waste disposal systems to supply water and contain or dispose of wastewater or solid wastes shall be 1 gallon (3.8 L) per 12 occupants of supply water and 1.5 gallons (5.68 L) capacity per 12 occupants for containment of wastewater.

Exception: Where temporary water closets or lavatories are provided that do not require water, the requirement for supply and wastewater storage shall be permitted to be reduced proportional to the total required water closets and lavatories.

702.5 702.4 Ventilation. Occupied space in *tornado shelters* shall be provided with *natural ventilation* in accordance with Section **702.5.1 702.4.1** or with mechanical ventilation in accordance with Section **702.5.2 702.4.2**. Openings used for atmospheric pressure change (APC) are permitted to be counted as ventilation for the purposes of this section. Ventilation openings for natural and mechanical ventilation shall comply with Sections **702.5.3 702.4.3** and **702.5.4 702.4.4**.

702.5.1 702.4.1 Natural ventilation. *Tornado shelters* that rely on *natural ventilation* shall be provided with the minimum ventilation area in accordance with Table **702.5.1 702.4.1**.

**TABLE 702.5.1 702.4.1
VENTING AREA REQUIRED FOR TORNADO SHELTERS**

TORNADO SHELTER TYPE	VENTING AREA (PER OCCUPANT)
Residential	2* square inches
Community, <i>design occupant capacity</i> < 50	5 square inches
Community, <i>design occupant capacity</i> => 50	6 square inches

* See exception to Section **702.5.1.1 702.4.1.1**.

For SI: 1 square inch = 645.2 mm².

702.5.1.1 702.4.1.1 Location of natural ventilation openings. Configuration of *natural ventilation* openings required for *tornado shelters* shall be such that a minimum of 25 percent of the required area is located within 46 inches (2581 mm) of the floor, or in the lower one-half of the height of the *tornado shelter*, whichever is less, with the balance, but not less than 50

Use of this document constitutes your agreement to abide by the User Agreement located at the beginning of this document.

percent of the required area located a minimum of 72 inches (1829 mm) above the floor, or in the upper one-fourth of the height of the *tornado shelter*, whichever is greater. Lower and upper openings shall be dispersed and located on walls or roof surfaces to provide cross ventilation of the *tornado shelter*. For *tornado shelters* with multiple stories, *natural ventilation* openings shall be provided for the occupants served for each story.

Exception: Air intake openings for *residential tornado shelters* shall be permitted to be located entirely in the upper half of the *tornado shelter* provided that the venting area is increased to 4 square inches (1290 mm²) per *tornado shelter* occupant.

702.5.1.2 702.4.1.2 Mechanical vents. Mechanical vents, louvers or dampers used to operate *ventilation* openings shall be connected to a standby power system.

IS-STM 07-05-23 AM

702.5.2 702.4.2 Mechanical ventilation. *Tornado shelters* that rely on mechanical ventilation shall be provided with the minimum mechanical ventilation rate of required outdoor air at a minimum rate of **5 2.5** cubic feet per minute (**0.00118 m³/s**) per occupant for the *design occupant capacity*. The mechanical ventilation system shall be connected to a standby power system.

702.5.3 702.4.3 Intake openings. Outside air intake openings shall be separated a minimum of 10 feet (3048 mm) horizontally from any hazardous or noxious contaminant, such as generator vents or exhaust, fuel storage tank vents and containers, maintenance or custodial storage facilities.

702.5.4 702.4.4 Opening protection. Air exhaust or intake openings that terminate outside of *occupied storm shelter areas* and *occupant support areas* shall be considered openings and shall be protected in accordance with Section 306.4. Ventilation openings that penetrate the *storm shelter envelope* between the *host building* and storm shelter shall also comply with the provisions of Section 603.

IS-STM 07-06-23 AS

702.6 Electrical grounding and bonding of tornado shelters. Exposed metal surfaces within *tornado shelters* shall be electrically bonded and grounded where required by Article 250 of NFPA 70 or by the *authority having jurisdiction*.

IS-STM 07-06-23 AS

702.7 Exit signs and emergency lighting. In *community tornado shelters*, in the event of a power supply failure, an emergency power system shall supply power for the exit signs and the emergency exit lighting in accordance with the *International Building Code*.

IS-STM 07-06-23 AS

702.8 Standby lighting. *Community tornado shelters* shall be provided with a standby lighting system. The standby lighting system shall provide illumination levels of not less than 1 foot-candle (11 lux) at the walking surface in *occupied storm shelter areas* and *occupant support areas*. The standby lighting system shall be connected to a standby power system.

Use of this document constitutes your agreement to abide by the User Agreement located at the beginning of this document.

Exception: Personal-use lighting devices such as flashlights with a minimum of 150 lumens or *approved* equivalent lighting devices shall be permitted for *tornado shelters* with a *design occupant capacity* of less than 50. Lighting devices shall be provided at a quantity not less than one per 10 occupants and readily available within the *storm shelter*.

IS-STM 07-06-23 AS

~~702.9~~ ~~702.8~~ ~~702.5~~ **Standby power.** Where required by Section 702.4 or ~~702.8~~, *community tornado shelters* shall be provided with a standby power system. The standby power system shall support *occupied storm shelter areas* and *occupant support areas*.

IS-STM 07-06-23 AS

~~702.9.1~~ ~~702.8.1~~ ~~702.5.1~~ **Capacity.** The standby power system shall have adequate capacity and rating to supply all required systems and circuits for standby lighting and any mechanical ventilation systems intended to be operated at one time.

IS-STM 07-06-23 AS

~~702.9.2~~ ~~702.8.2~~ ~~702.5.2~~ **Duration.** The standby power system shall be designed to provide continuously the required output capacity for a minimum of 2 hours.

IS-STM 07-06-23 AS

~~702.9.3~~ ~~702.8.3~~ ~~702.5.3~~ **Protection of components.** Standby power supply, transformers, distribution panels, cabling, fuel supply storage tanks, fuel lines and power supply to *storm shelter critical support system* components shall be protected in accordance with Section 701.2.

~~702.10~~ ~~702.9~~ **First aid kit.** A Class A first aid kit complying with ANSI/ISEA I Z308.1 shall be supplied in all *community tornado shelters*.

SECTION 703 HURRICANE SHELTERS

IS-STM 07-02-23

703.1 General. *Hurricane shelters* shall comply with the requirements of Sections 703.2 through ~~703.11~~ ~~703.12~~.

IS-STM 03-02-23 AM; IS-STM 07-02-23

~~703.2~~ ~~701.2~~ **Protection of hurricane storm shelter critical support systems.** ~~Storm Hurricane~~ *shelter critical support systems* shall remain functional for the design storm event and a minimum period of ~~storm shelter occupancy (24 hours for hurricane shelters, 2 hours for tornado shelters).~~ ~~Storm Hurricane~~ *shelter critical support systems* located outside of the ~~storm hurricane~~ *shelter* areas shall be protected by a means that meets the ~~tornado and~~ wind load and impact requirements of Chapter 3, and, as applicable, the flood-resistance requirements of Chapter 4.

Use of this document constitutes your agreement to abide by the User Agreement located at the beginning of this document.

703.3 703.2 Exterior weather protection. All exposed components and cladding assemblies and roof coverings of *hurricane shelters* shall be designed to resist rainwater penetration during the hurricane and shall be designed and installed to meet the wind load requirements of Section 304.

703.3.1 703.2.1 Door weather seal. Doors in the shelter envelope that are also exterior doors to the building shall have a weather seal provided at the undercut.

IS-STM 07-03-23 AS

703.4 703.3 703.3.1 Water closets and lavatories. Water closets and lavatories shall be either permanent plumbing fixtures installed within the *hurricane shelter*, or temporary water closets, such as chemical toilets, or temporary lavatories, such as chemical toilets such as portable hand washing stations, or other means approved by the authority having jurisdiction.

IS-STM 07-03-23 AS

703.4.1 703.3.1 703.3 Minimum number water closets and lavatories. Water closets and lavatories shall be located within the *hurricane shelter* and provided in the minimum number indicated in Table 703.3 703.4.1 703.3.1.

IS-STM 07-03-23 AS

**TABLE 703.3 703.4.1 703.3.1
REQUIRED WATER CLOSETS AND LAVATORIES
FOR HURRICANE SHELTERS**

HURRICANE SHELTER TYPE	WATER CLOSETS	LAVATORIES
Residential, one-and two-family dwellings	Not Required	Not Required
Residential, other	1	Not Required
Community, <i>design occupant capacity</i> < 50	1	Not Required
Community, <i>design occupant capacity</i> => 50	1 per 50 occupants	1 per 100 occupants

703.4.2 703.3.2 Water closet and lavatory calculations. The number of water closets and lavatories shall be allocated in accordance with the *International Plumbing Code*.

703.4.2.1 703.3.2.1 Urinals. Urinals shall be permitted to be substituted for water closets in accordance with the *International Plumbing Code*.

703.4.3 703.3.3 Water closet privacy. Each water closet shall occupy a separate compartment with walls, partitions, curtains or equivalent that enclose the water closet to ensure privacy.

703.4.4 703.3.4 Sanitation support method. A sanitation support method for the water closets or lavatories shall be capable of supplying water and containing waste for the *design occupant capacity* of the *hurricane shelter*.

IS-STM 07-07-23 AS (Errata – indicated change as 07-03-23)

Use of this document constitutes your agreement to abide by the User Agreement located at the beginning of this document.

703.4.4.1 703.3.4.1 Storage capacity for water supply and ~~waste-water~~ wastewater. In community shelters with a *design occupant capacity* of 50 or greater, the capacity of plumbing and waste disposal systems to supply water and contain or dispose of ~~waste-water~~ **wastewater** or solid wastes shall be 1 gallon (3.8 L) per occupant of supply water in addition to the drinking water required in Section ~~703.4~~ **703.5** and 1.5 gallons (5.68 L) **capacity** per occupant for **containment of ~~waste-water~~ wastewater**.

Exception: Where temporary water closets or lavatories are provided that do not require water, the requirement for supply and ~~waste-water~~ **wastewater** storage shall be permitted to be reduced proportional to the total required water closets and lavatories.

703.5 703.4 Drinking water. For *community hurricane shelters* at least 1 gallon (3.8 L) of drinking water shall be provided for each occupant.

703.6 703.5 Rainwater drainage for hurricane shelter facilities.

The rooftop drainage system of a *hurricane shelter* shall be designed for the rainfall rates in Section ~~703.6.1 703.5.4~~ through ~~703.6.3 703.5.3~~.

703.6.1 703.5.4 Rainfall rate for the primary roof drainage system. Rainfall rate for the primary roof drainage system of a *hurricane shelter* shall be determined by adding 3 inches (76 mm) of rainfall per hour to the 100-year, 1-hour rainfall rate. The 100-year, 1-hour rainfall rate shall be determined from Figures ~~303.1.1 (1) through 303.1.1(5)~~ or *approved* local weather data.

703.6.2 703.5.2 Rainfall rate for the secondary (overflow) drainage systems. The rainfall rate for the secondary (overflow) drainage systems shall be determined by adding 6 inches (152 mm) of rainfall per hour to the 100-year, 1-hour rainfall rate. The 100-year, 1-hour rainfall rate shall be determined from Figures ~~303.1.1 (1) through 303.1.1(5)~~ or *approved* local weather data.

703.6.3 703.5.3 Rainwater drainage for hurricane shelter facilities. Rainwater drainage shall be provided for *hurricane shelter* facilities where that rainwater will be impounded and flood *occupied storm shelter areas, occupant support areas and storm shelter critical support systems* or access routes. The rainfall rate shall be determined by adding 6 inches (152 mm) per hour to the 100-year, 1-hour rainfall rate. The 100-year, 1-hour rainfall rate shall be determined from Figure ~~303.1.1 (1) through 303.1.1(5)~~ or *approved* local weather data.

IS-STM 07-09-23 AS (Errata – indicated change as 07-03-23)

703.7 703.6 Ventilation. Occupied spaces in *hurricane shelters* shall be provided with *natural ventilation* in accordance with Section ~~703.7.1 703.6.4~~. **Occupied space in community hurricane shelters with a Where the *design occupant capacity* is of 50 or greater the storm shelter shall also be ventilated by with mechanical means in accordance with Section ~~703.7.2 703.6.2~~. Ventilation openings for natural and mechanical ventilation shall comply with Sections ~~703.7.3 703.6.3~~ and ~~703.7.4 703.6.4~~.**

703.7.1 703.6.4 Natural ventilation. All *hurricane shelters* shall be provided with openings to facilitate minimum *natural ventilation* in accordance with this section. The area of ventilation openings shall comply with Table ~~703.7.1 703.6.4~~. Where *hurricane shelters* are also designed as *tornado shelters*, openings provided to relieve internal pressure for atmospheric pressure change (APC) in accordance with Section 304.7 shall be permitted to be counted as *natural ventilation* openings.

Use of this document constitutes your agreement to abide by the User Agreement located at the beginning of this document.

TABLE ~~703.7.1~~ ~~703.6.1~~
VENTING AREA REQUIREMENTS FOR HURRICANE SHELTERS

SHELTER TYPE	VENTING AREA (PER OCCUPANT)
Residential	4 square inches
Community, <i>design occupant capacity</i> < 50	8 square inches
Community, <i>design occupant capacity</i> => 50	12 square inches

For SI: 1 square inch = 645.2 mm².

~~703.7.1.1~~ ~~703.6.1.1~~ Location of ventilation openings. Configuration of *natural ventilation* openings required for *hurricane shelters* shall be such that a minimum of 25 percent of the required area is located within 46 inches (1168 mm) of the floor, or in the lower one-half of the height of the *hurricane shelter*, whichever is less, with the balance, but not less than 50 percent of the required area, located a minimum of 72 inches (1829 mm) above the floor, or in the upper one-fourth of the height of the *hurricane shelter*, whichever is greater. Lower and upper openings shall be dispersed and located on walls or the roof surfaces to provide cross ventilation of the *hurricane shelter*. For *hurricane shelters* with multiple stories, *natural ventilation* openings shall be provided for the occupants served for each story.

~~703.7.1.2~~ ~~703.6.1.2~~ Mechanical vents. Mechanical vents, louvers or dampers used to operate *ventilation* openings shall be connected to a standby power system.

~~703.7.2~~ ~~703.6.2~~ Mechanical ventilation. The minimum mechanical ventilation rate of required outdoor air shall be determined at a minimum rate of 5 cubic feet per minute (0.00236 m³/s) per occupant for the *design occupant capacity*. The mechanical ventilation system shall be connected to a standby power system.

~~703.7.3~~ ~~703.6.3~~ Intake openings. Outside air intake openings shall be separated a minimum of 10 feet (3048 mm) horizontally from any hazardous or noxious contaminant, such as generator vents or exhaust, fuel storage tank vents and containers, maintenance or custodial storage facilities.

~~703.7.4~~ ~~703.6.4~~ Opening protection. Air exhaust or intake openings that terminate outside of *occupied storm shelter* areas and *occupant support areas* shall be considered openings and shall be protected in accordance with Section 306.4. Ventilation openings that penetrate the *storm shelter envelope* between the *host building* and *storm shelter* shall also comply with the provisions of Section 603.

IS-STM 07-06-23 AS

703.8 Electrical grounding and bonding of hurricane shelters. Exposed metal surfaces within *hurricane shelters* shall be electrically bonded and grounded where required by Article 250 of NFPA 70 or by the *authority having jurisdiction*.

IS-STM 07-06-23 AS

Use of this document constitutes your agreement to abide by the User Agreement located at the beginning of this document.

703.9 Exit signs and emergency lighting. In *community hurricane shelters*, in the event of a power supply failure, an emergency power system shall supply power for the exit signs and the emergency exit lighting in accordance with the *International Building Code*.

IS-STM 07-06-23 AS

703.10 Standby lighting. *Community hurricane shelters* shall be provided with a standby lighting system. The standby lighting system shall provide illumination levels of not less than 1 foot-candle (11 lux) at the walking surface in *occupied storm shelter areas*, and *occupant support areas*. The standby lighting system shall be connected to a standby power system.

Exception: Personal-use lighting devices such as flashlights with a minimum of 150 lumens or *approved* equivalent lighting devices shall be permitted for *hurricane shelters* with a *design occupant capacity* less than 50. Lighting devices shall be provided at a quantity not less than one per 10 occupants and readily available within the *storm shelter*.

IS-STM 07-06-23 AS

703.11 703.10 703.7 Standby power. Where required by Section 703.5 703.6 or 703.9 703.10, *community hurricane shelters* shall be provided with a standby electrical power system. The standby power system shall support *occupied storm shelter areas* and *occupant support areas*.

IS-STM 07-06-23 AS

703.11.1 703.10.1 703.7.1 Capacity. The standby power system shall have adequate capacity and rating to supply all required systems and circuits for standby lighting and any mechanical ventilation systems intended to be operated at one time.

IS-STM 07-06-23 AS

703.11.2 703.10.2 703.7.2 Duration. The standby power system shall be designed to provide continuously the required output capacity for a minimum of 24 hours.

IS-STM 07-06-23 AS

703.11.3 703.10.3 703.7.3 Independence. The standby power supply shall be located *on-site*, and shall be independent of off-site sources of fuel or water.

IS-STM 07-06-23 AS

703.11.4 703.10.4 703.7.4 Protection of components. Standby power supply, transformers, distribution panels, cabling, fuel supply storage tanks, fuel lines and power supply to *storm shelter critical support system* components shall be protected in accordance with Section 701.2.

IS-STM 07-06-23 AS; IS-STM 07-12-23 AM

703.10.5 703.7.5 Location. Standby power supply shall be accessible by a protected access route. The access route shall be located within the *hurricane shelter* or shall meet the provisions for exterior wall and roof *impact-protective systems* in accordance with this standard.

Use of this document constitutes your agreement to abide by the User Agreement located at the beginning of this document.

703.12 ~~703.11~~ First aid kit. A Class A first aid kit complying with ANSI/ISEAI Z308.1 shall be supplied in all *community hurricane shelters*.

Exception: A first aid kit is not required where equivalent first aid supplies are located in the building.

CHAPTER 8

TEST METHODS FOR IMPACT AND PRESSURE TESTING

SECTION 801 GENERAL

801.1 Scope. This testing protocol covers procedures for conducting impact and static and cyclic pressure testing of components of the *storm shelter envelope* required to meet impact provisions, as detailed in Section 305.

SECTION 802 TEST SPECIMENS

IS-STM 03-02-23 AM; IS-STM 08-10 AM/AFM PC2

802.1 Test assembly General. All parts of the test *specimen* shall be full size, using the same materials, details, methods of construction and methods of attachment as proposed for actual use. Testing of components consisting of wall assemblies, roof assemblies, or *impact-protective systems* shall be allowed in lieu of testing entire *storm shelters*.

Where failure of framing members controls the impact performance, wall and roof assemblies subjected to impact testing shall be a minimum of 4 feet (1219 mm) wide and the full length of the span of the wall or roof section from support to support. Where failure of framing members has been shown through testing to not control the impact performance, wall and roof sections subjected to debris impact testing shall be a minimum of 4 feet (1219 mm) wide by 4 feet (1219 mm) high unless dimensions of the actual assembly are less than these dimensions.

Impact-protective systems shall be impact tested and cyclic pressure tested where applicable, at the maximum and minimum size *listed* for use. Static pressure testing shall be conducted on the maximum size *listed* for use. Operable door assemblies and window assemblies shall be tested for the conditions of swing and latching including inward or outward swing separately as specified for use of the product. *Impact-protective systems* shall be static pressure tested in both directions unless a clear worst-case direction is determined by the *test laboratory*. Paired doors and their latching hardware shall be tested independently from single doors. The *specimen* shall consist of the entire assembled unit and shall, where practical, be mounted as it will be installed in a *storm shelter*, and shall contain all devices used to resist **tornado and** wind forces and wind-borne debris. Where it is not practical to install for testing door assemblies and window assemblies as they will be mounted in a *storm shelter*, then the unit or assembly shall be mounted in a test buck to connect the *specimen* to the test frame, stand or *test chamber*. Details of the mounting shall be described in the test report.

802.2 Number of test specimens. Where static pressure and impact testing are required, each test shall be permitted on a separate *specimen*. Where required, cyclic pressure testing shall be on the same *specimen* as the impact testing.

IS-STM 08-10 AM/AFM PC2

Use of this document constitutes your agreement to abide by the User Agreement located at the beginning of this document.

802.3 Test specimen conditioning. Samples shall be conditioned at ambient temperature [59°F to 95°F (15°C to 35°C)] for a minimum of 2 hours prior to testing.

802.4 Specifications and drawings. The manufacturer or constructor shall provide the *test laboratory* with applicable product specifications and drawings detailing materials of construction and applicable installation details. The *test laboratory* shall verify conformance of the test *specimen* to the product specifications and drawings.

IS-STM 08-01-23 AM

802.5 Fire, pressure, and impact testing ~~Testing for fire-resistance rating.~~ Materials, elements or assemblies ~~Wall assemblies, roof assemblies and impact-protective systems~~ required to have ~~testing for compliance with the a fire-resistance rating ratings or fire-protection ratings~~ required by Section 603, and ~~required to have~~ pressure and impact testing ~~conducted~~ in accordance with Chapter 8, shall be subjected to fire testing separately from the pressure and impact testing. Fire testing shall be permitted on separate *specimens* from the pressure and impact testing.

SECTION 803 IMPACT TESTING

803.1 Apparatus. The general description of the apparatus for performing the impact testing requirements of this standard is detailed in Section 6 of ASTM E1886.

803.2 Calibration. Calibration of the speed measuring system shall be performed in accordance with the procedure detailed in Section 9 of ASTM E1886.

803.3 Missile impact procedure. Test *specimens* shall be impact tested with test missiles of size and speed as specified in Section 305. Impact testing procedure shall be performed as detailed in Sections 11.1 through 11.3 of ASTM E1886. The minimum number of impact locations shall be as detailed in Section 803.9.

803.4 Missile properties. The test missile weight shall be selected to meet the requirements of Section 305 and shall comply with Sections 803.4.1 through 803.4.3.

803.4.1 Wood species. Any common softwood lumber species as defined by DOC PS 20 shall be permitted to be used provided that it meets the length tolerances detailed below. The lumber shall be grade stamped No. 2 or better and be free of splits, checks, wane or other significant defects. The 2 by 4s used shall be straight such that any bow or warp measured by stretching a string or wire on the side of the board from end to end is within ~~0.5~~ $\frac{1}{2}$ -inch of the 2 by 4s surface over its entire length.

803.4.2 Missile length and weight tolerance. The wood density, including moisture content, shall be such that the required 15 ± 0.25 pound (6.8 ± 0.11 kg) weight is met with a length of between 10 feet (3048 mm) and 15 feet (4572 mm). The 9 ± 0.25 pound (4.1 ± 0.11 kg) weight is met with a length between 6 feet (1829 mm) and 10 feet (3048 mm). The sabot and attachment screws shall be included in the missile weight where it is permanently attached. Missile weights shall be confirmed within 2 hours prior to their use.

803.4.3 Conditioning. The test missile shall be conditioned at ambient temperature [59°F to 95°F (15°C to 35°C)] for a minimum of 2 hours prior to testing.

Use of this document constitutes your agreement to abide by the User Agreement located at the beginning of this document.

803.5 Sabot size and weight. Where the missile launching system requires the use of a sabot for the effective launching of the missile, the sabot shall weigh no more than $\frac{1}{2}$ pound (0.226 kg), and shall be included in the weight of the missile, unless it is stripped away during flight prior to impact.

803.6 Missile speed. Missile speed measurement and speed tolerances shall be in accordance with Sections 803.6.1 and 803.6.2.

803.6.1 Missile speed measurement. The missile speed shall be measured by a device capable of measuring the missile velocity to within ± 1 foot per second (0.305 m/s).

803.6.2 Missile speed tolerance. The missile test speed tolerance is 4 mph (1.8 m/s) above and 0 mph (0 m/s) below the missile speed prescribed in Section 305.

803.7 Impact angle. Missile impacts shall be within 5 degrees of normal to the primary plane of the test *specimen*. This requirement is deemed to be met when the barrel of the cannon is aligned within ± 2 degrees of perpendicular in the horizontal plane and between level and a 3-degree upward incline in the vertical plane.

803.8 Testing temperature. The testing shall be conducted at ambient temperature in the range of 59°F to 95°F (15°C to 35°C).

IS-STM 08-02-23 AS; IS-STM 08-03-23 AS/AFM PC2

803.9 Impact locations and the number of impacts. For purposes of testing impact-protective systems, impact locations and quantities shall be as indicated in Sections 803.9.1 through 803.9.7.3, as applicable. The tolerance for impact locations shall be that the center of the missile profile shall impact within a $2\frac{1}{2}$ inch (64 mm) radius circle, with the center of the circle located as indicated in Sections 803.9.1 through 803.9.7.3, as applicable.

IS-STM 08-03-23 AS/AFMPC1; IS-STM 08-05-23 AS/AFM BC1

803.9.1 Panel or framed wall assemblies and roof assemblies. Sections of panel or framed wall assemblies and roof assemblies shall be impacted in the center of the section, and at one interface corner. See examples as detailed in Figures 803.9.1(1) and 803.9.1(2). Where an interior stud or support is present at the center of the wall section, the center wall impact shall be adjusted to strike impact centered between studs or supports.

Where an interior stud or support is present, additional impacts shall be performed within 3 inches (76 mm) of the stud or support, and directly on a stud support. See examples, as detailed in Figures 803.9.1(1) and 803.9.1(2).

Interface joints used for attachment or joining at corners, at panel-to-panel sections, or at panel-to-roof shall be impacted directly on the interface joints each type of interface joint. See examples as detailed in Figure 803.9.1(2) for each type of joint.

Where a section contains lapped materials, the centered impact shall be adjusted to strike impact the center of any lap, and an additional impact shall be performed within 3 inches (76 mm) of the lap on the panel that laps behind the seam. See examples as detailed in Figure 803.9.1(2).

No more than three impacts shall be made on one *specimen*. Where more than three impacts are required, multiple identical test *specimens* shall be provided.

Exception: More than three impacts shall be permitted to be made on the same test *specimen* by mutual consent of the test sponsor and *test laboratory*.

TEST SPECIMEN
PANEL WITHOUT JOINT

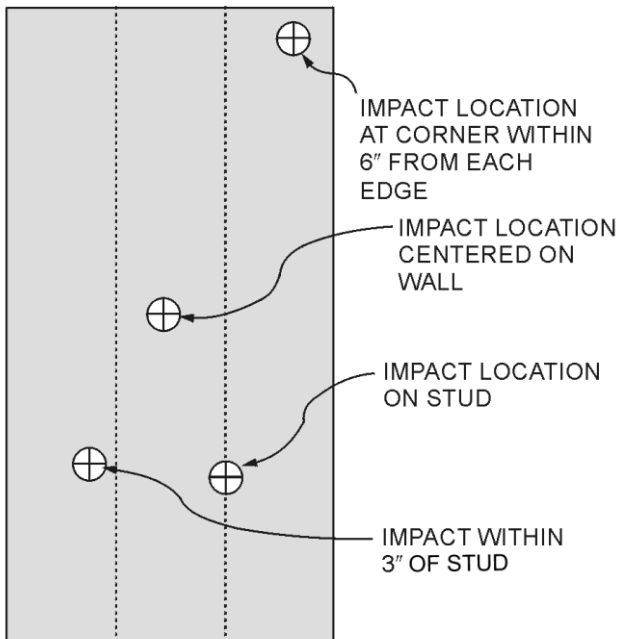

FIGURE 803.9.1(1)
PANEL OR FRAMED WALL ASSEMBLIES AND ROOF ASSEMBLIES

TEST SPECIMEN
PANEL WITH JOINT

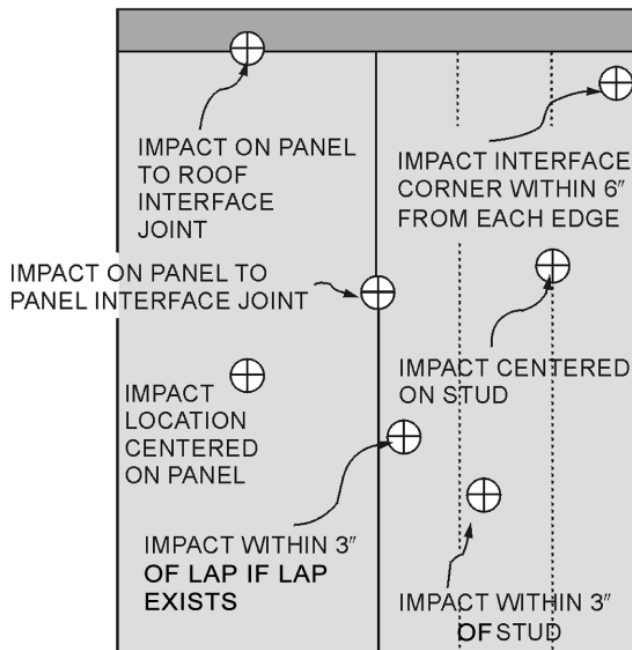

FIGURE 803.9.1(2)
PANEL OR FRAMED WALL ASSEMBLIES AND ROOF ASSEMBLIES

IS-STM 08-05-23 AS/AFM BC1

803.9.2 Solid wall assemblies and roof assemblies of concrete or other materials. Sections of wall assemblies and roof assemblies of solid concrete or other solid material shall be impacted in the center of the section, and at one interface corner. See example as detailed in Figures 803.9.2(1) and 803.9.2(2). Where interface joints are used for joining at corners or panel-to-panel joints, an additional section shall be impacted directly on the interface joints. See example as detailed in Figure 803.9.2(2).

Where an interior stud or support is present, additional impacts shall be performed within 3 inches (76 mm) of the stud and support, and directly on the stud support. See example as detailed in Figures 803.9.2(1) and 803.9.2(2).

No more than three impacts shall be made on one *specimen*. Where more than three impacts are required, multiple identical test *specimens* shall be provided.

Exception: More than three impacts shall be permitted to be made on the same test *specimen* by mutual consent of the test sponsor and *test laboratory*.

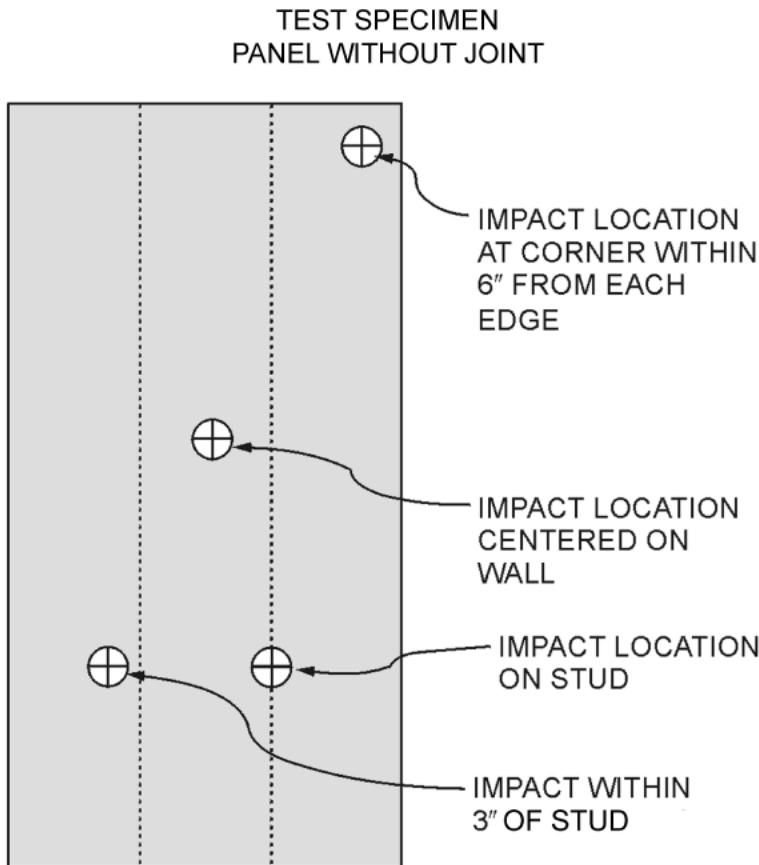

**FIGURE 803.9.2(1)
SOLID WALL ASSEMBLIES AND ROOF ASSEMBLIES OF CONCRETE OR OTHER MATERIALS**

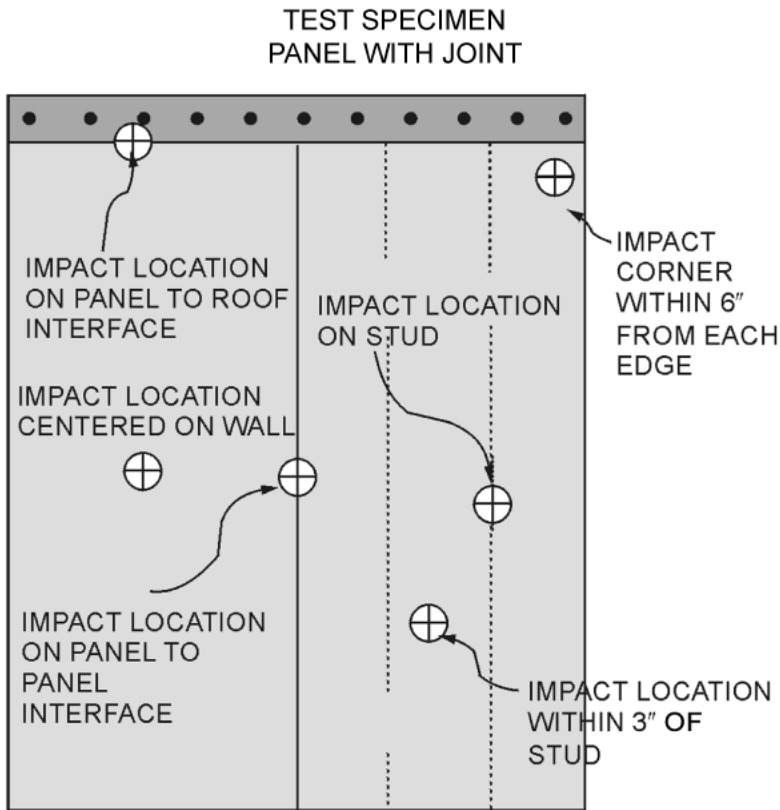

FIGURE 803.9.2(2)
SOLID WALL ASSEMBLIES AND ROOF ASSEMBLIES OF CONCRETE OR OTHER MATERIALS

IS-STM 08-05-23 AS/AFM BC1

803.9.3 Masonry unit wall assemblies and roof assemblies. Sections of wall assemblies and roof assemblies constructed of masonry units shall be impacted in the center of the section, and at one interface corner or joint. See example as detailed in Figure 803.9.3(1). Mortared joints shall be impacted directly on the interface joints. See example as detailed in Figure 803.9.3(2).

No more than three impacts shall be made on one *specimen* or specimen panel. Where more than three impacts are required, multiple identical test *specimens* shall be provided.

Exception: More than three impacts shall be permitted to be made on the same test *specimen* by mutual consent of the test sponsor and *test laboratory*.

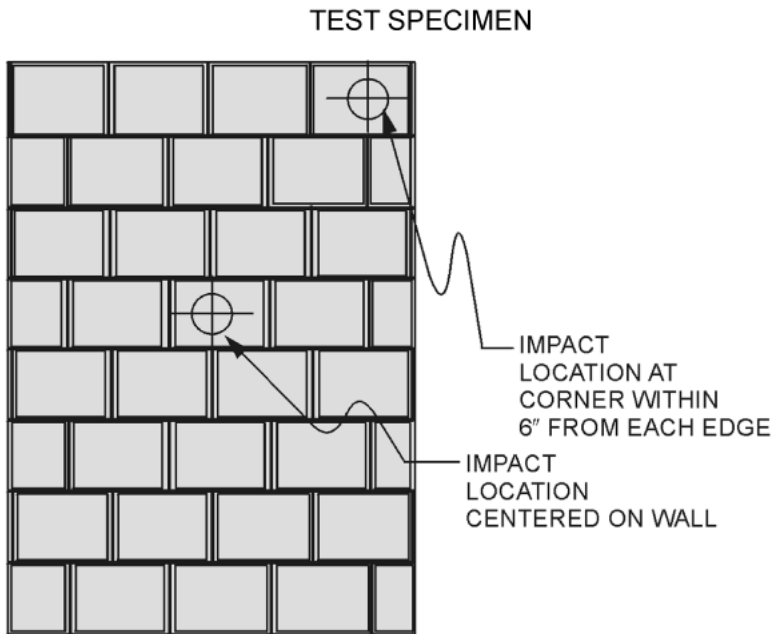
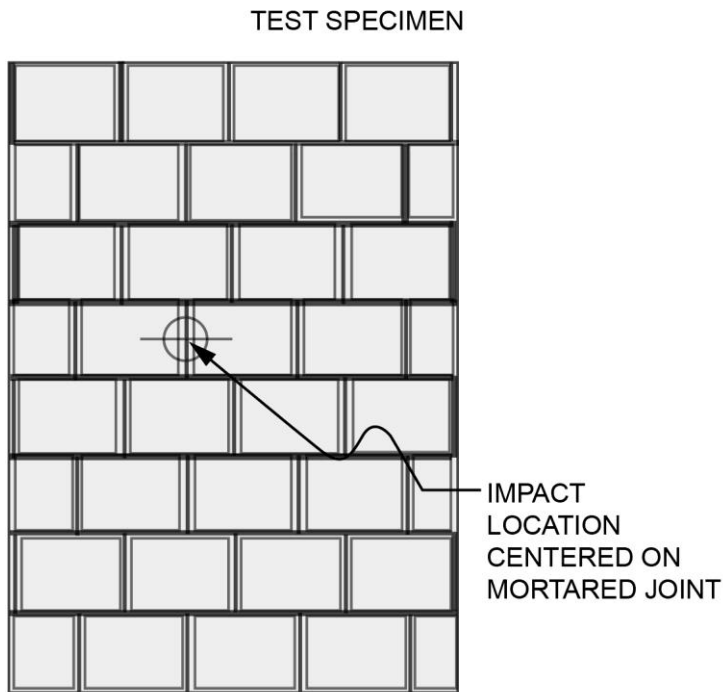

FIGURE 803.9.3(1)
MASONRY UNIT WALL ASSEMBLIES AND ROOF ASSEMBLIES



IS-STM 08-04-23 AS (revised figure removed upper note and target)

For SI: 1 inch = 2.54 mm.

FIGURE 803.9.3(2)
MASONRY UNIT WALL ASSEMBLIES AND ROOF ASSEMBLIES

803.9.4 Door assemblies. Door assemblies shall comply with Section 803.9.4.1, 803.9.4.2 or 803.9.4.3, as applicable. Glazed openings in doors shall comply with Section 803.9.4.4.

IS-STM 08-05-23 AS/AFM BC1

803.9.4.1 Side-swinging door assemblies. Side-swinging door assemblies shall be impacted within 6 inches (152 mm) of an interface hinge joint, within 6 inches (152 mm) of an upper latch point and within 6 inches (152 mm) of center primary latches or operators. **See example as shown** in Figure 803.9.4.1(1).

For double door assemblies with each door leaf containing identical hardware, one door leaf shall receive the same three impacts as a single door leaf plus an additional impact on a center meeting point or mullion. **See example as shown** in Figure 803.9.4.1(2).

For double door assemblies where one or more hardware components differ between door leaves, each door leaf shall receive the same three impacts as a single door and an additional impact on a center meeting point or mullion. **See example as shown** in Figure 803.9.4.1(2).

No more than four impacts shall be made on one *specimen*. Where more than four impacts are required, multiple identical test *specimens* shall be utilized. Impacts shown on the same leaf in Figure 803.9.4.1(2), shall occur on the same test *specimen*.

Exception: More than four impacts shall be permitted to be made on the same test *specimen* by mutual consent of the test sponsor and *test laboratory*.

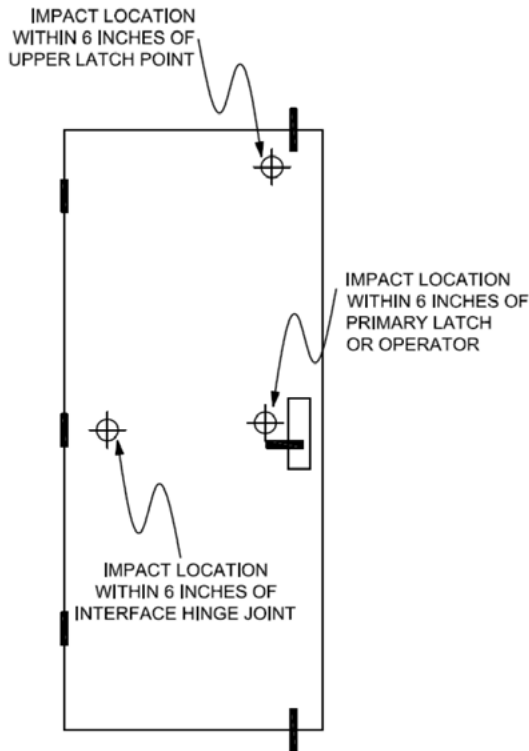

For SI: 1 inch = 2.54 mm.

**FIGURE 803.9.4.1(1)
SINGLE DOOR TEST SPECIMEN**

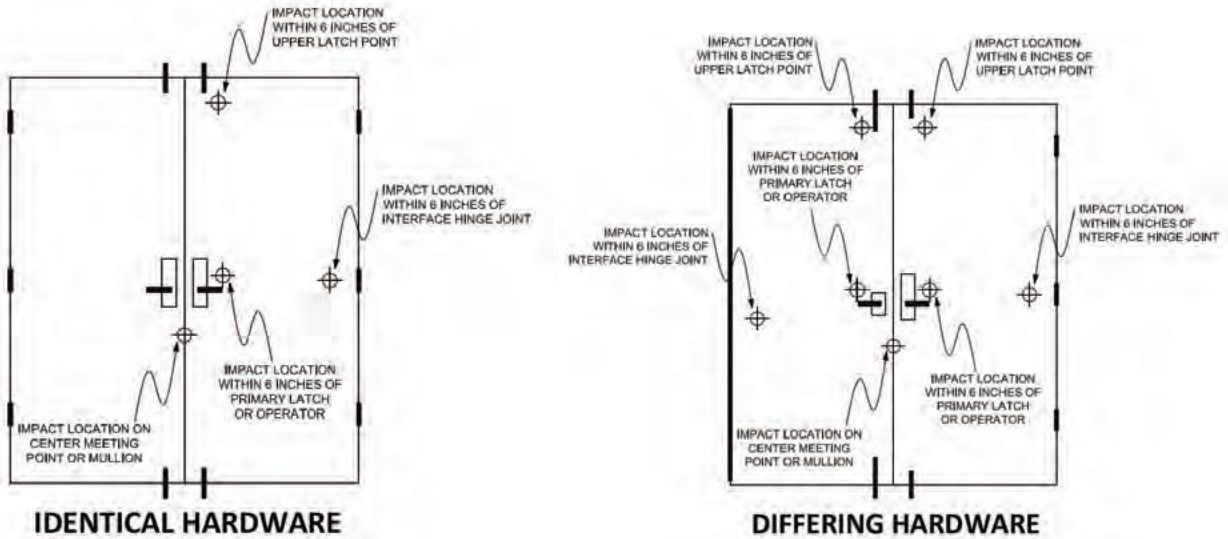
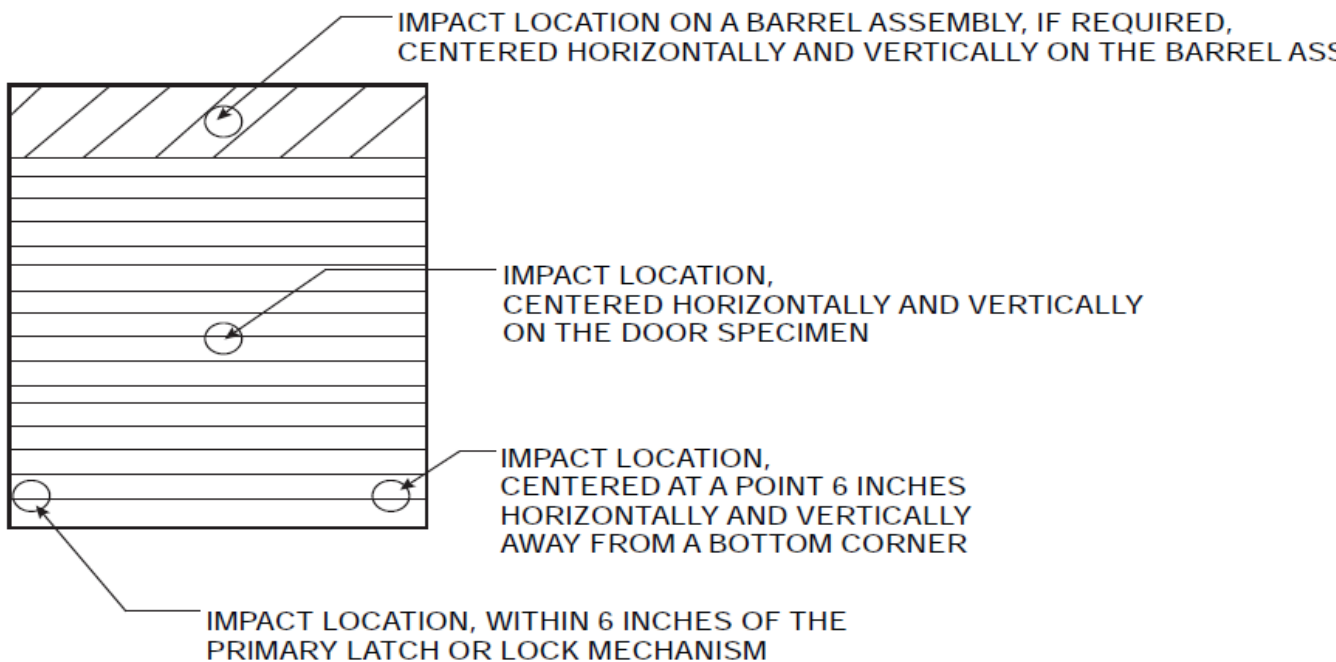

FIGURE 803.9.4.1(2)
DOUBLE DOOR ASSEMBLIES

IS-STM 08-05-23 AS/AFM BC1 & BC2

803.9.4.2 Rolling door assemblies. For *rolling door assemblies*, the door shall be impacted at the center of the door, centered at a point within 6 inches (152 mm) horizontally and vertically away from a bottom corner and within 6 inches (152 mm) of the primary latch or lock mechanism, plus an additional impact centered on a barrel assembly. See example as shown in Figure 803.9.4.2.

Exception: The barrel assembly is not subject to the additional impact where the entire barrel assembly is protected by the shelter envelope.



Use of this document constitutes your agreement to abide by the User Agreement located at the beginning of this document.

For SI: 1 inch = 2.54 mm.

FIGURE 803.9.4.2

ROLLING DOOR ASSEMBLIES

IS-STM 08-05-23 AS/AFM BC2

803.9.4.3 Sectional door assemblies. For *sectional door assemblies*, the door shall be impacted centered on a section joint at a hinge location nearest the midpoint of the test specimen, equidistant between the lower two section joints and centered between two vertical stiles, centered at a point within 6 inches (152 mm) horizontally and vertically away from a bottom corner, and within 6 inches (152 mm) of the primary latch or lock mechanism as shown. See example in Figure 803.9.4.3.

IS-STM 08-05-23 AS – revised figure move location of target for lock or latch

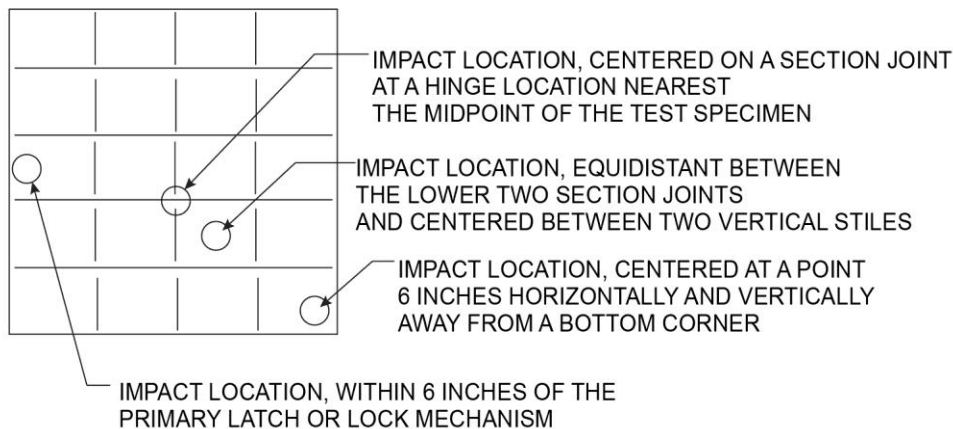

For SI: 1 inch = 2.54 mm.

FIGURE 803.9.4.3

SECTIONAL DOOR ASSEMBLIES

803.9.4.4 Glazed openings in doors. Where the door contains glazed openings with a height of 12 inches (305 mm) or less and a width of 12 inches (305 mm) or less, an additional sample shall be impacted in the center of the glazed opening. Where the door contains glazed openings with a height or width greater than 12 inches (305 mm), the glazed opening shall be treated as a window assembly and tested in accordance with Section 803.9.5.

IS-STM 08-06-23 AM/AFM PC1; IS-STM 08-05-23 AS/AFM BC1

803.9.5 Window assemblies and other glazed openings. All window assemblies and other glazed openings shall be impacted in the center of the smallest glazed section, and at the lock side corner, or one interface corner, a corner within 6 inches from each edge. Where a lock/latch is provided on the test specimen, the corner impact shall occur nearest the lock/latch, as applicable, one interface corner as detailed. See example in Figure 803.9.5(1). Where interior mullions or other glazed section joints and/or latches are present, the assembly shall be impacted centered on the mullion and at base of mullion, additional

Use of this document constitutes your agreement to abide by the User Agreement located at the beginning of this document.

impacts shall be applied on these features as shown See example in Figure 803.9.5(2). Interface hinge joints and primary latches, where present, shall be impacted. See example in Figure 803.9.4.1(2) on an additional specimen.

No more than two impacts shall be made on one specimen. Where more than two impacts are required, multiple identical test specimens shall be provided.

Exception: More than two impacts shall be permitted to be made on the same test specimen by mutual consent of the test sponsor and test laboratory.

TEST SPECIMEN

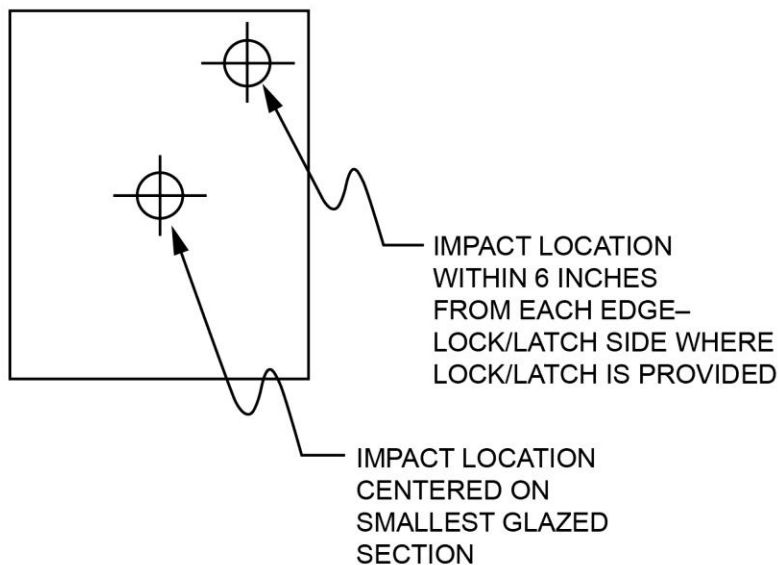

IS-STM 08-06-23 AM/AFM PC1 – add 'interface corner' top note

(Note: Change note for corner to 'impact location within 6 inches from each edge – lock/latch side where lock/latch is provided' – this is revised figure from Julia)

**FIGURE 803.9.5(1)
WINDOW ASSEMBLIES AND OTHER GLAZED OPENINGS**

TEST SPECIMEN

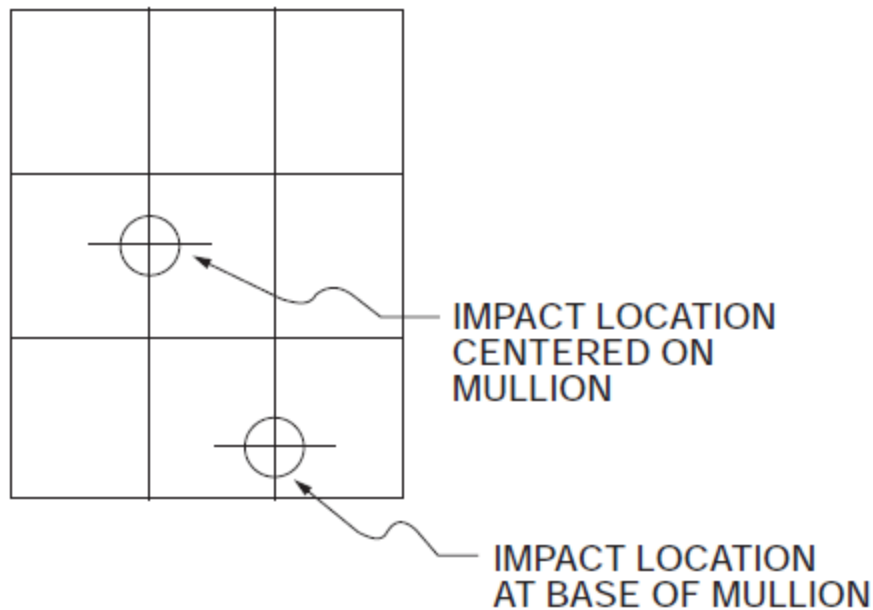

For SI: 1 inch = 25.4 mm.

FIGURE 803.9.5(2)
WINDOW ASSEMBLIES AND OTHER GLAZED OPENINGS

IS-STM 08-10-23 AM; IS-STM 08-06-23 AM/AFM PC2 and PC3; IS-STM 03-10-23 AM/AFM BC1

803.9.6 Other impact-protective systems system assemblies. All other Other impact-protective systems system assemblies shall be impacted in the center of the test specimen the worst-case section as determined by the test laboratory, and at a perimeter corner within 6 inches (152 mm) from each edge. Where a lock/latch is provided on the test specimen, the corner impact shall occur nearest the lock/latch, and at one interface corner as detailed See example in Figure 803.9.6(1).

Panels and interface joints shall be additionally impacted onto on the same unit test specimen centered at a seam or lap and at the center of a panel element, unless previously impacted at the same location on the same test specimen, as shown See example in Figure 803.9.6(2). Interface hinge joints and primary latches, where present, shall be impacted as shown in Figure 803.9.4.1(2) on an additional specimen. All impact-protective systems that include swinging door assemblies with latching hardware shall be tested in accordance with Section 803.9.4.

Where an interior stud or support is present, additional impacts onto the same unit test specimen shall be performed within 3 inches (76 mm) of the stud and or support, and directly on the stud or support, as detailed See examples in Figure Figures 803.9.2(1) or 803.9.2(2).

Use of this document constitutes your agreement to abide by the User Agreement located at the beginning of this document.

All *impact-protective systems* that include hinged or pivoted assemblies shall be tested in accordance with the applicable requirements of Section 803.9.4 on an additional test specimen.

Exception: The same test specimen shall be permitted to be used to satisfy the requirements of Sections 803.9.6 and 803.9.4 by mutual consent of the test sponsor and test laboratory.

Glazed openings in other *impact-protective systems* shall be treated the same as glazed openings in doors and shall comply with Section 803.9.4.4.

Louvers shall be additionally impacted at the midspan of the blade's longest unsupported span, unless previously impacted at the same location on the same test specimen.

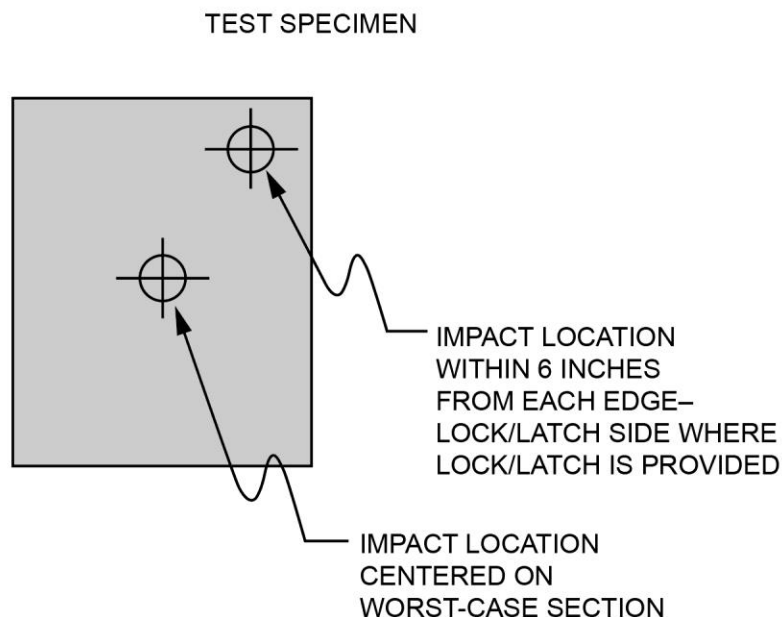

IS-STM 08-10-23 AM

FIGURE 803.9.6(1)

OTHER IMPACT-PROTECTIVE SYSTEMS

(Note: Change note for corner to 'impact location within 6 inches from each edge – lock/latch side where lock/latch is provided' – this is revised figure from Julia)

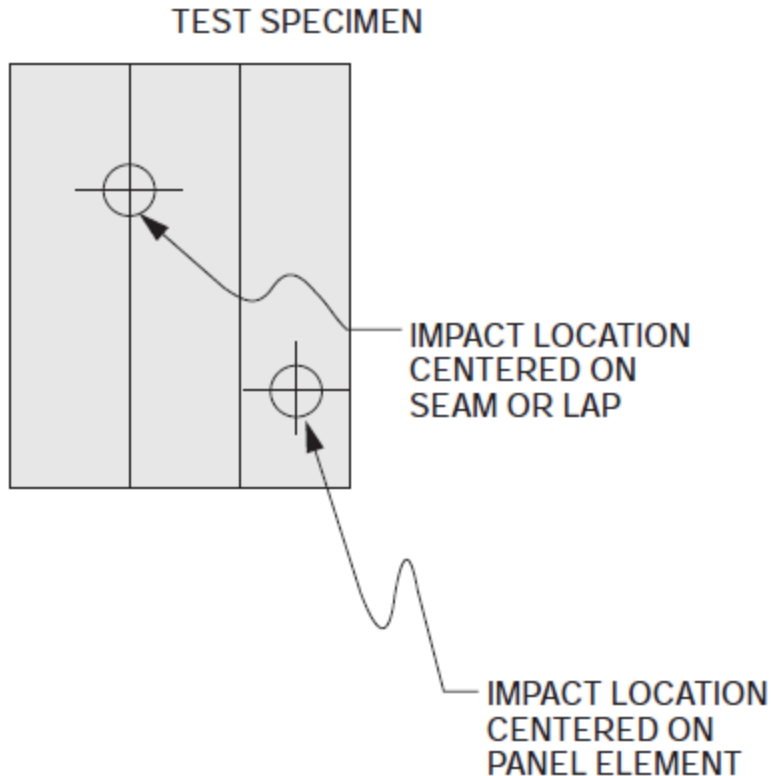

For SI: 1 inch = 25.4 mm.

FIGURE 803.9.6(2)
OTHER IMPACT-PROTECTIVE SYSTEMS

IS-STM 08-11-23 AS

803.9.7 Alcove or baffled storm shelter entry systems. Impact testing described in this section required for alcove or baffled *storm shelter entry systems* shall meet the requirements of Sections 304 and 305. See Figure 803.9.7 for an example of an alcove or baffle *storm shelter entry system*. Impact test requirements are presented for systems that comply with one of the following:

1. The missile impacts at least twice on wall or roof assemblies meeting the requirements of Section 306.3 prior to entering the *protected occupant area*. Straight missile paths and elastic impacts are assumed in determining missile trajectories. Test requirements for this type of system are presented in Section 803.9.7.1. Examples of this type of system are shown in Figure 803.9.7.1. The boundary between the *protected occupant area* and the unprotected occupant area shall be clearly marked on the floor and walls of the *storm shelter*.
2. The missile impacts initially a wall or roof assembly meeting the requirements of Section 306.3 and possibly rebounds to impact a door assembly. Straight missile paths and elastic impacts are assumed in determining missile trajectories. The impact test requirements for

this type of system are presented in Section 803.9.7.2. Examples of this type of system are shown in **Figure Figures 803.9.7.1 and 803.9.7.2.**

3. The missile impact on a door assembly is limited to an angle less than 90 degrees (1.57 rad) by *impact-protective systems*. The impact test requirements for this type of system are presented in Section 803.9.7.3. Examples of this type of system are shown in Figure 803.9.7.3.

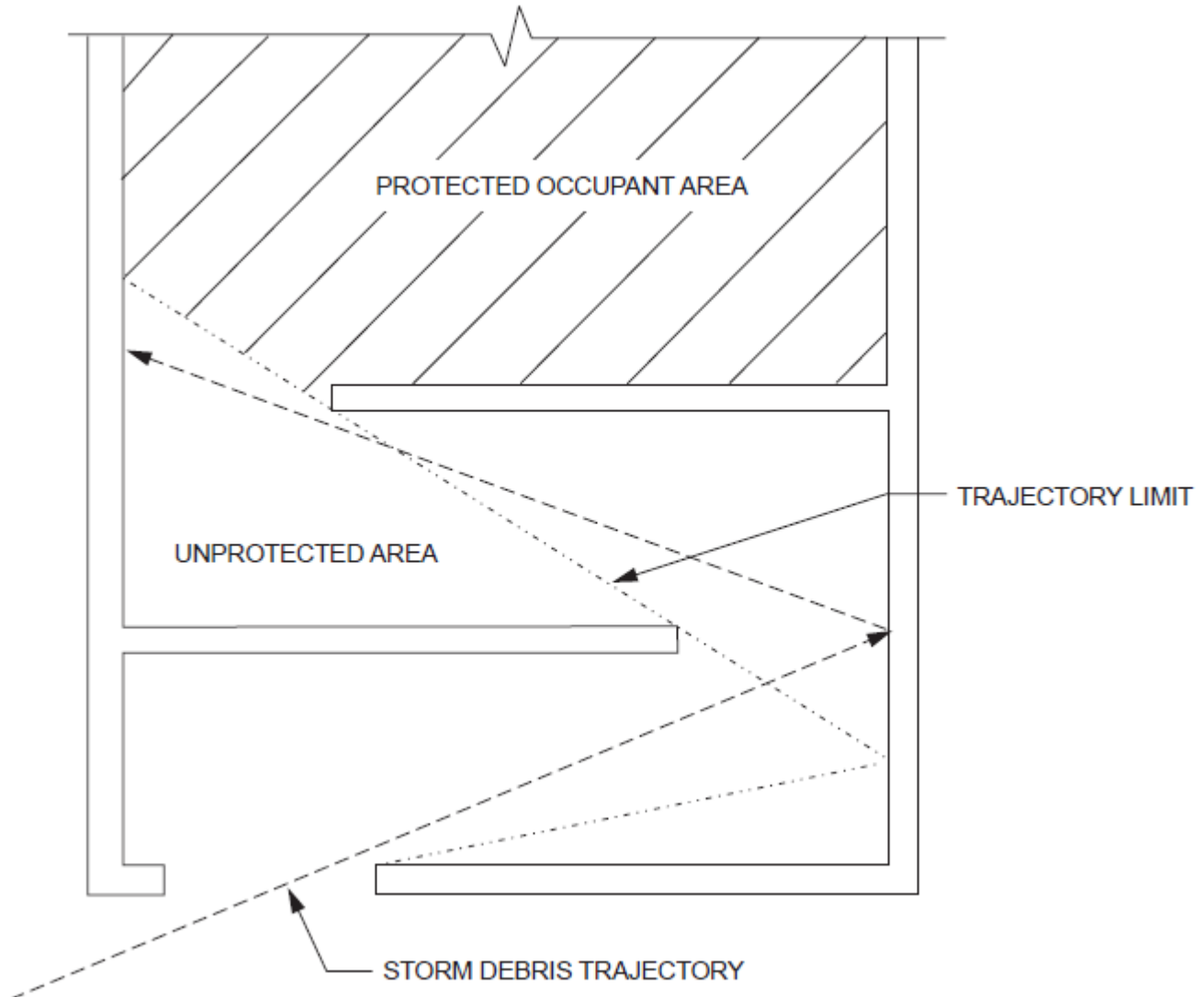

**FIGURE 803.9.7
ALCOVE OR BAFFLED STORM SHELTER ENTRY SYSTEM**

IS-STM 03-02-23 AM

803.9.7.1 Alcove or baffled storm shelter entry systems for which no testing is required. Storm shelter entrances, whether provided with a door assembly or not, that are protected by an *alcove or baffled storm shelter entry system* that require missiles to impact at least two surfaces meeting the requirements of Section 306.3 prior to arriving at the *protected occupant area* shall not be required to undergo impact testing. See Figure 803.9.7.1 for an example. Where a solid door assembly is installed as a closure for this type of entry

Use of this document constitutes your agreement to abide by the User Agreement located at the beginning of this document.

system or to meet the fire-resistance requirements in Section 603, the door assembly need not meet the **tornado and** wind load requirements of Section 304.

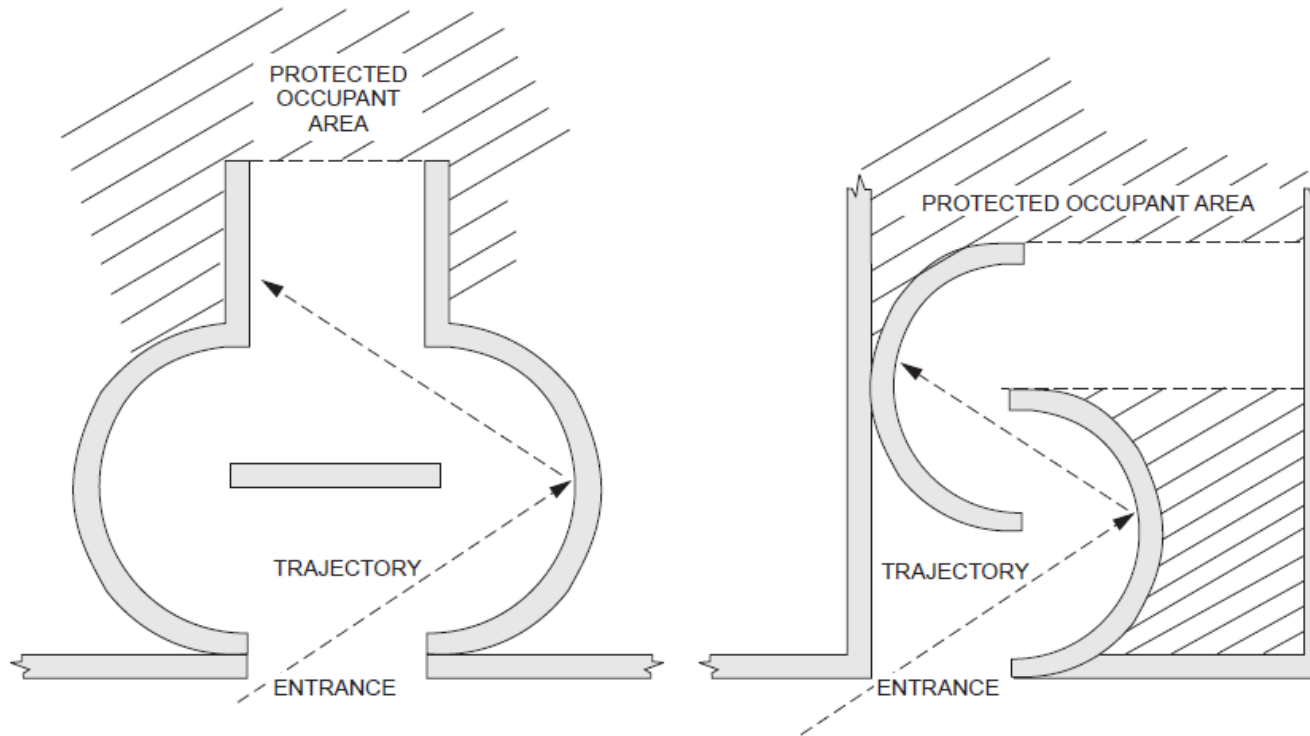

FIGURE 803.9.7.1
ALCOVE OR BAFFLED STORM SHELTER ENTRY SYSTEMS FOR WHICH TESTING IS REQUIRED

IS-STM 03-02-23 AM

803.9.7.2 Door assembly subject to rebound impact. Where the *alcove or baffled storm shelter entry system* prevents a first impact of the missile on the door assembly but the door assembly is subject to a *rebound impact* of the missile after it has impacted one surface meeting the requirements of Section 306.3 (see Figure 803.9.7.2 for an example), then a door assembly shall meet the **tornado and** wind load requirements of Section 304 and the impact requirements of Section 305 except that the missile shall be, at a minimum, a 9-pound (4.1 kg) sawn lumber 2 by 4 traveling at 50 feet per second (15.2 m/s). Entry systems having door assemblies that are protected from the initial and first *rebound impacts* of missile shall comply with the requirements of Section 803.9.7.1.

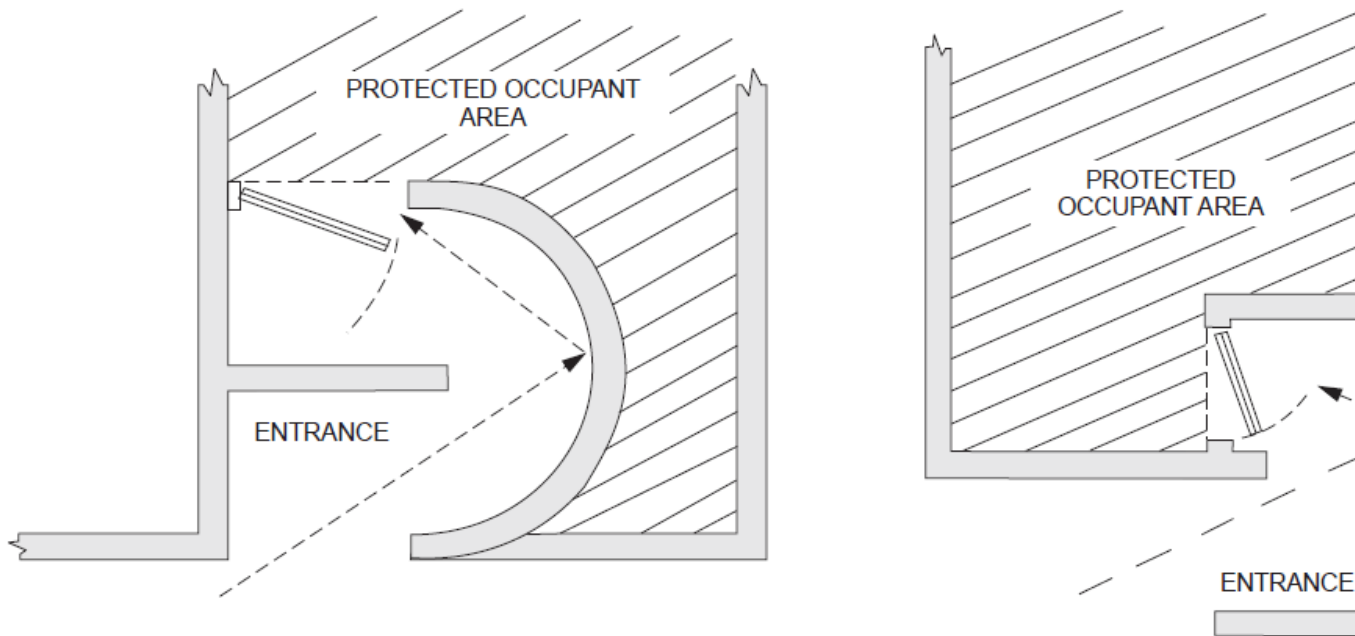

FIGURE 803.9.7.2
DOOR ASSEMBLIES SUBJECT TO REBOUND IMPACT

IS-STM 08-12-23 AS; IS-STM 08-03-23 AM/AFM PC1

803.9.7.3 Door assemblies subject to first impact. Where a first-~~strike impact~~ angle missile will impact on the door assembly (see Figure 803.9.7.3 for an example) the door assembly shall meet the ~~tornado or~~ wind load requirements ~~of Section 306.3~~, the fire-resistance requirements of Section 603, and ~~meets meet~~ one of the following debris impact criteria:

1. The door assembly withstands the impact of a missile ~~striking impacting~~ the door assembly at an angle closest to perpendicular to the plane of the door.
2. The door assembly withstands missile impacts by the design missile ~~striking impacting~~ perpendicular to the surface with speed equal to or greater than the *storm shelter* design missile's velocity component perpendicular to the door assembly for the most critical angle that can occur in the application.

The minimum debris impact criterion for the door assembly shall be an impact perpendicular to the door assembly of a 9-pound (4.1 kg) sawn lumber 2 by 4 traveling at 50 feet per second [34 mph (15.2 m/s)].

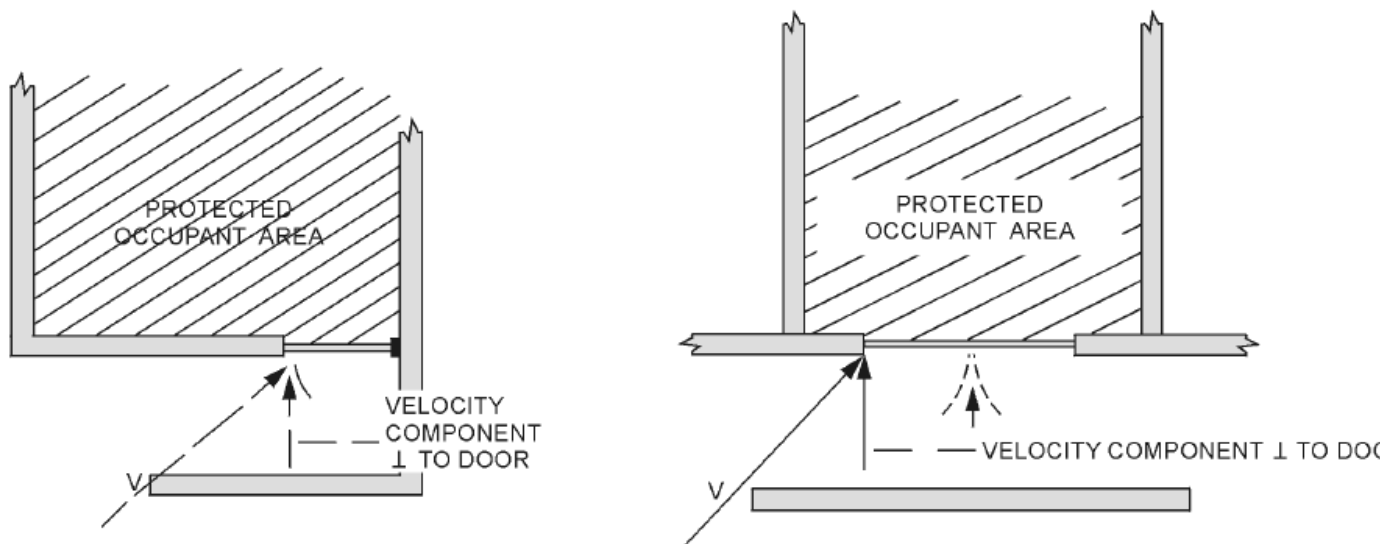

FIGURE 803.9.7.3
DOOR ASSEMBLIES SUBJECT TO REBOUND IMPACT

803.10 Pass or fail. The pass or fail criteria for impact testing shall be in accordance with Sections 803.10.1 through 803.10.4.

IS-STM 08-13-23 D/AFMBC2

803.10.1 Perforation. Any perforation of the interior surface of the tested component of the *storm shelter envelope* by the design missile shall constitute a failure. For *impact-protective systems*, perforation or deflection that would result in impact of the protected component constitutes a failure.

803.10.2 Dislodgment and disengagement. *Specimens* and load-bearing fasteners, where used, shall not become disengaged or dislodged during the test procedures so as to endanger occupants. Disengagement or dislodgment that occurs in a test shall be demonstrated to not endanger occupants by failing to perforate a #70 unbleached kraft paper witness screen. The surface of the witness screen shall be secured in place on a rigid frame installed not more than 5 inches (127 mm) from the innermost component deemed by the *test laboratory* to be most susceptible to disengagement or dislodgment. The rigid frame shall maintain tautness of the kraft paper and shall have continuous supports in one direction at intervals no greater than 3 feet (914 mm).

803.10.3 Spall. Excessive spall shall not be released from the interior surface of any *specimen* during the test procedures so as to endanger occupants. Excessive spall is defined as that which perforates a #70 unbleached kraft paper witness screen. The surface of the witness screen shall be secured in place on a rigid frame installed not more than 5 inches (127 mm) from the innermost surface of the *test specimen* deemed by the *test laboratory* to be most susceptible to spalling. The rigid frame shall maintain tautness of the kraft paper and shall have continuous supports in one direction at intervals no greater than 3 feet (914 mm).

803.10.4 Permanent deformation. Permanent deformation of an interior surface of the test *specimen* shall be determined by measuring the distance from a straight edge held between

two undeformed points on the *specimen*. The maximum permanent deformation shall be measured to the nearest $\frac{1}{8}$ inch (3.2 mm) and shall not exceed 3 inches (76 mm).

IS-STM 08-13-23 D/AFM PC2

803.10.5 Maximum Deflection. The maximum deflection under impact testing shall not result in perforation of the witness screen detailed in Sections 803.10.2 and 803.10.3. For *impact protective systems* that are intended for installation to the exterior of a protected component, impact deflection that would result in contact with the protected component constitutes a failure.

IS-STM 08-14-23 AM reconsideration

803.11 Minimum Reporting Requirements. At a minimum, the test report reporting for impact testing shall include the following items as applicable:

1. The dates of testing and report issuance.
2. The names and addresses of the test sponsor and *test laboratory*.
3. The product name and model number.
4. A description of the tested *specimens*, including all parts and components, and the number of *specimens* tested.
5. Dimensioned drawings, verified by the *test laboratory* as representative of the tested assembly, including: section profiles; framing layout; type and spacing of anchorage; hardware make, model, and location; and any other pertinent construction details.
6. A description of the *test chamber* mounting, when where used.
7. The ambient temperature at the time of testing.
8. The weight of each impact test missile measured within 2 hours of use.
9. The launch speed of each impact test missile.
10. The location of the kraft paper witness screen, including identification of the component deemed most susceptible to disengagement, dislodgement, or spall in accordance with Sections 803.10.2 and 803.10.3.
11. A statement of observations after each missile impact including permanent deformation and details of any damage, disengagement, dislodgement, spall, or other pertinent observations.
12. A statement that testing was conducted in accordance with ICC 500, including the edition.
13. A statement of compliance or non-compliance with each of the requirements in Section 803.10.
14. A sketch or photograph indicating the locations of impact on each tested assembly.
15. Photos of the interior and exterior of the tested assembly, before and after impact.

SECTION 804 STATIC AND CYCLIC PRESSURE TESTING

804.1 Apparatus. The general description of the apparatus for performing the static and cyclic pressure testing requirements of this standard is detailed in Section 6 of ASTM E330 when performing the static pressure test, or ASTM E1886 when performing the cyclic pressure test.

804.2 Calibration. Calibration of the pressure measuring system shall be performed in accordance with the procedure detailed in Section 9 of ASTM E330 or ASTM E1886.

Use of this document constitutes your agreement to abide by the User Agreement located at the beginning of this document.

IS STM 08-15-23 AS/AFM PC1

804.3 Cyclic pressure testing after impact. Test *specimens* requiring cyclic pressure testing shall be cyclic tested in accordance with ASTM E1886 using the loading sequence detailed in Table 1 of ASTM E1886 to the *design wind pressure*. The test *specimens* used shall be the same test *specimens* that received impact testing in accordance with Section 803. Cyclic pressure testing procedures shall be performed in accordance with the Air Pressure Cycling criteria as detailed in ASTM E1886.

Exception: The maximum allowable cycle time for *specimens* over 75 square feet (7 m²) in area shall be permitted to be calculated using the following equation:

Maximum allowable cycle time in seconds = (area of *specimen* in sq. ft. – 75) × 0.06 + ~~3~~5

In no case shall the maximum cycle time exceed ~~10~~ 20 seconds.

IS-STM 08-16-23 D/AFM PC1

804.3.1 Maximum Deflection Measurement. The maximum deflection of the test *specimen* shall be measured and recorded for each loading sequence during cyclic pressure testing. The deflection-measuring system shall comply with the requirements of Sections 6 and 9 of ASTM E330.

804.4 Testing temperature. The testing shall be conducted at room temperature in the range of 59°F (15°C) to 95°F (35°C).

SECTION 805 STATIC AND CYCLIC PRESSURE TESTING PROCEDURES

IS-STM 03-02-23 AM

805.1 Pressure testing procedures. For wall assemblies, roof assemblies and *impact-protective systems* that are components of the *storm shelter envelope*, static or cyclic pressure testing shall be in accordance with Sections 805.2 and 805.3, as applicable. *Design tornado pressure and design Design wind pressures* used for static or cyclic pressure testing of the *storm shelter envelope* shall be in accordance with Section 304.

IS-STM 03-02-23 AM

805.2 Wall assemblies and roof assemblies. Where testing of wall assemblies and roof assemblies is required, such assemblies shall be static pressure tested in the as-supplied condition. Static pressure testing of roof assemblies shall be conducted in accordance with FM 4474, ASTM E1592, UL 1897 or ASTM E330, whichever is applicable, to a static pressure 1.2 times the *design tornado pressure and design wind pressure* or greater. Static pressure testing of wall assemblies shall be conducted in accordance with ASTM E330 to 1.2 times the *design tornado pressure and design wind pressure* or greater.

805.3 Impact-protective systems. Testing of *impact-protective systems* shall be conducted in the as-supplied condition as specified in Sections 805.3.1 or 805.3.2.

IS-STM 03-02-23 AM

805.3.1 Tornado shelters. *Impact-protective systems* for use in *tornado shelters* shall be tested for static pressure to a pressure of 1.2 times the *design tornado wind pressure* or greater in accordance with ASTM E330.

Use of this document constitutes your agreement to abide by the User Agreement located at the beginning of this document.

IS-STM 08-15-23 AS

805.3.2 Hurricane shelters. *Impact-protective systems* for use in *hurricane shelters* shall be static pressure tested to a pressure of 1.2 times the *design wind pressure* or greater in accordance with ASTM E330 and subjected to cyclic pressure testing in accordance with ASTM E1886. Cyclic pressure testing shall follow the impact testing required in Section 803.

Exception: Cyclic pressure testing is not required for *side-swinging* door assemblies without glazing where such assemblies are static pressure tested to a pressure of 1.5 times the *design wind pressure* or greater in accordance with ASTM E330.

IS-STM 08-16-23 AM

805.4 Pass or Fail. The pass or fail criteria for static or cyclic pressure testing shall be in accordance with Sections 805.4.1 through 805.4.3.

IS-STM 08-16-23 AM

805.4.1 Pressure Resistance. The test *specimen* shall sustain the applied static or cyclic pressure for the required duration.

IS-STM 08-16-23 AM

805.4.2 Permanent Deformation. Permanent deformation of an interior surface of the test *specimen* shall be determined by measuring the distance from a straight edge held between two undeformed points on the *specimen*. The maximum permanent deformation after static or cyclic loading shall be measured to the nearest 1/8 inch (3.2 mm) and shall not exceed 3 inches (76 mm).

IS-STM 08-16-23 AM

805.4.3 Maximum Deflection. The maximum deflection under static or cyclic design pressure shall not exceed 5 inches (127 mm). For *impact-protective systems* that are intended for installation to the exterior of a protected component, deflection that would result in contact with the protected component constitutes a failure.

Exception: Deflections in excess of 5 inches (127 mm) are permitted where the maximum deflection under design pressure is indicated in the certification listing.

IS-STM 08-17-23 AM

805.5 Minimum Reporting Requirements. At a minimum, reporting for static and cyclic pressure testing shall include the following items as applicable:

1. The dates of testing and report issuance.
2. The names and addresses of the test sponsor and *test laboratory*.
3. The product name and model number.
4. A description of the tested *specimens*, including all parts and components, and the number of *specimens* tested.
5. Dimensioned drawings, verified by the *test laboratory* as representative of the tested assembly, including: section profiles; framing layout; type and spacing of anchorage; hardware make, model, and location; and any other pertinent construction details.
6. A description of the *test chamber* mounting, where used.

Use of this document constitutes your agreement to abide by the User Agreement located at the beginning of this document.

7. The ambient temperature at the time of testing.
8. When static pressure testing is conducted, a tabulation of applied pressure differences, their duration, and the maximum resulting deflection.
9. When cyclic pressure testing is conducted, a tabulation of the applied pressure differences, their average cycle times, the number of cycles and the maximum resulting deflection.
10. A statement of observations after testing including permanent deformation and details of any damage or other pertinent information.
11. A statement that testing was conducted in accordance with ICC 500, including the edition.
12. A statement of compliance or non-compliance with each of the requirements in Section 805.4.
13. Photos of the interior and exterior of the tested assembly, before and after testing.

CHAPTER 9

REFERENCED STANDARDS

This chapter lists the standards that are referenced in various sections of this document. The standards are listed herein by the promulgating agency of the standard, the standard identification, the effective date and title, and the section or sections of this document that reference the standard.

ACI

American Concrete Institute
38800 Country Club Drive
Farmington Hills, MI 48331

Standard reference number	Title	Referenced in code section number
ACI 318—19	Building Code Requirements for Structural Concrete	307.2
ACI 332—19	Residential Code Requirements for Structural Concrete	307.2

ASCE

American Society of Civil Engineers
Structural Engineering Institute
1801 Alexander Bell Drive
Reston, VA 20191-4400

Standard reference number	Title	Referenced in code section number
IS-STM 03-02-23 AM, IS-STM 09-01-23 AS; IS-STM 09-02-23 AM 7—1622	Minimum Design Loads and Associated Criteria for Buildings and Other Structures with Supplement No. 1	301.1, 302.1, 302.2, 303.1, 303.2, 304.1, 304.7
24—14	Flood Resistant Design and Construction.....	401.3

ASTM

ASTM International
100 Barr Harbor Drive
West Conshohocken, PA 19428-2959

Use of this document constitutes your agreement to abide by the User Agreement located at the beginning of this document.

Standard reference number	Title	Referenced in code section number
C920—18	Standard Specification for Elastomeric Joint Sealants.....	
IS-STM 09-01-23 AS		
E330/E330M—14	(2021) Standard Test Method for Structural Performance of Exterior Windows, Doors, Skylights and Curtain Walls by Uniform Static Air Pressure Difference.....	805.1,805.2, 806.2, 806.3.2.1, 806.4.1, 806.5.1, 806.5.2
E1592—05	(Reapproved 2017) Standard Test Method for Structural Performance of Sheet Metal Roof and Siding Systems by Uniform Static Air Pressure Difference	805.2
E1886—19	Standard Test Method for the Performance of Exterior Windows, Curtain Walls, Doors and Impact Protective Systems Impacted by Missile(s) and Exposed to Cyclic Pressure Differentials.....	805.1, 805.2, 805.3, 806.3.1.2, 806.3.2.2, 806.4.2

DOC

U.S. Department of Commerce
National Institute of Standards and Technology
100 Bureau Drive Stop 3460
Gaithersburg, MD 20899

Standard reference number	Title	Referenced in code section number
PS 20—20	American Softwood Lumber Standard	804.4.1

FM

FM Approvals
Headquarters Office
1151 Boston-Providence Turnpike
P.O. Box 9102
Norwood, MA 02062

Standard reference number	Title	Referenced in code section number
IS-STM 09-01-23 AS		
4474—	(2011 2020) American National Standard for Evaluating the Simulated Wind Uplift Resistance of Roof Assemblies Using Static Positive and/or Negative Differential Pressures	805.2

ICC

International Code Council, Inc.
500 New Jersey Ave, NW

Use of this document constitutes your agreement to abide by the User Agreement located at the beginning of this document.

6th Floor
Washington, D.C. 20001

Standard reference number	Title	Referenced in code section number
IS-STM 09-01-23 AS		
IBC— 24 24	International Building Code®	501.6
ICC A117.1— 17 23	Accessible and Usable Buildings and Facilities	504.1.1
IPC— 24 24	International Plumbing Code®	702.3.2, 702.3.2.1, 703.3.2, 703.3.2.1
IRC— 24 24	International Residential Code®	104.2, 105.1, 303.3.1, 402.5

ISEA

International Safety Equipment Association
1901 North Moore Street, Suite 808,
Arlington, Virginia 22209

Standard reference number	Title	Referenced in code section number
ANSI/ISEA Z308.1—2015	Minimum Requirements for Workplace First Aid Kits and Supplies	702.9, 703.11

NFPA

National Fire Protection Association
1 Batterymarch Park
Quincy, MA 02269-9101

Standard reference number	Title	Referenced in code section number
IS-STM 06-08-23 AM	IS-STM 09-01-23 AS/AFM BC1	
NFPA-10— 1822	Portable Fire Extinguishers	602.2
NFPA-70— 1723	National Electrical Code	702.5, 703.9

TMS

The Masonry Society
105 South Sunset Street, Suite Q
Longmont, CO 80501

Standard reference number	Title	Referenced in code section number
IS-STM 09-01-23 AS		

Use of this document constitutes your agreement to abide by the User Agreement located at the beginning of this document.

602—	2016 2022	Specification for Masonry Structures	306.5
------	------------------	--	-------

UL

UL LLC
 333 Pfingsten Road
 Northbrook, IL 60062.2096

Standard reference number	Title	Referenced in code section number
IS-STM 09-01-23 AS		
UL1897—15	Standard for Safety for Uplift Tests for Roof Covering Systems	
through September 2020	with revisions	805.2

APPENDIX A

STORM SHELTER PREPAREDNESS AND EMERGENCY OPERATIONS PLAN (SSPEOP)

The provisions contained in this appendix are not mandatory unless specifically referenced in the adopting ordinance.

User notes:

About this appendix: Appendix A provides optional criteria for the storm shelter preparedness and emergency operation plan. Criteria for basic information, preparedness and emergency operations procedures are provided. Plans will be dependent on the size and operation of the individual shelters and staff.

SECTION A101 GENERAL

A101.1 Scope. Community storm shelters shall have a storm shelter preparedness and emergency operations plan (SSPEOP) that complies with the provisions of this appendix. The intent of this appendix is to provide minimum plan requirements for:

1. Establishment of basic parameters (Section 104).
2. Developing and maintaining a state of preparedness to efficiently function in the event of a tornado or hurricane (Section 105).
3. Storm shelter emergency operational procedures in response to the threat from a tornado or hurricane (Section 106).

The SSPEOP shall specify the storm shelter storm type as tornado or hurricane, and include information required herein, as determined by the designated *storm shelter management team* and the *authority having jurisdiction*. Where the *community storm shelter* is designed for both hurricanes and tornadoes, the SSPEOP should cover both storm types where different measures apply.

A101.2 Approval. The SSPEOP shall be submitted for approval by the *authority having jurisdiction* or Emergency Management Department where the shelter is designated for use by the general public.

IS-STM 01-02-23 AS/AFM BC1

A101.3 Availability. A copy of the SSPEOP shall be maintained **at the facility** at all times. ~~The SSPEOP and~~ shall be available in the **facility storm shelter** for reference and review by the designated *storm shelter management team*, ~~and a~~ **A** copy shall be provided by the owner or owner's representative for **maintenance by** the *authority having jurisdiction* or Emergency Management Agency where the shelter is designated for use by the general public.

SECTION A102 DEFINITIONS

Use of this document constitutes your agreement to abide by the User Agreement located at the beginning of this document.

A102.1 General. The following terms shall have, for the purpose of this appendix, the meanings as follows:

STORM SHELTER MANAGEMENT TEAM. Staff for the shelter that will be included in the development of the SSPEOP, along with the authority and jurisdiction, and those who will be involved with activation of the *storm shelter*, during and after activation of the *storm shelter*, as well as preparations and maintenance.

SECTION A103 SSPEOP REQUIREMENTS

Errata – change to 103.1 shown here – no change to this section.

A103.1 General. The SSPEOP shall include basic *storm shelters* information as required in Section A104; prepared-ness requirements as required in Section A105; and emergency operations requirements as required in Section A106.

SECTION A104 SSPEOP BASIC INFORMATION REQUIREMENTS

A104.1 General. An SSPEOP shall include basic information as required in Sections A104.2 through A104.5. The purpose of the basic information plan components is to establish and document *storm shelter* responsibility, basic parameters and floor plans. Site plans and registration are required where applicable.

A104.2 Responsibility. The SSPEOP shall include the identification and contact information for the entity or party responsible for operating the *storm shelter*. For *storm shelters* open to the general public, the plan shall identify the community organization responsible and no less than two active points of contact for the responsible organization. For *storm shelters* open to intended occupants only, the responsible party shall be the *storm shelter* owner or the owner's representative

A104.3 Parameters. The SSPEOP shall include the following basic storm shelter information:

1. Storm type. Tornado, hurricane or combination tornado-hurricane *storm shelter*.
2. Design duration of occupation. Two hours (tornado) or 24 hours (hurricane) minimum.
3. Multiuse or single-use. If multiuse, then include the function of the space when not being used as a *storm shelter*.
4. *Design occupant capacity*.
5. Identify who the intended occupants are, for example:
 - 5.1. *Host building*.
 - 5.2. Within a campus, defined property or boundary.
 - 5.3. General public.
6. Days and hours when the shelter will be operational for intended occupants including expectation of storm shelter use during off-hours, where applicable.

A104.4 Floor plans and site plans. The SSPEOP shall include floor plans for the *storm shelter*, and additional information for the *host building* and site where applicable.

IS-STM 05-06-23 AM; IS-STM A-01-23 AM

Use of this document constitutes your agreement to abide by the User Agreement located at the beginning of this document.

A104.4.1 Storm shelter floor plans. A storm shelter floor plan shall be provided. The plan shall indicate the following:

1. **Access Entry** and means of egress doors.
2. Emergency escape openings **and overhead hatches**, where provided.
3. *Impact-protective systems* that need to be secured in place.
4. Layout and function of *occupant support areas*.
5. Mechanical vents or mechanical ventilation systems that need to be activated, where provided.
6. Water closet and lavatory locations, including locations for set up of temporary water closets and lavatories, where provided.
7. **Emergency and** Standby power supply, where provided.
8. Storage of required supplies such as first aid kits and flashlights.
9. Location of fire extinguishers.

A104.4.2 Hurricane storm shelter floor plans. In addition to the items listed in Section A104.4.1, a hurricane storm shelter floor plan shall indicate the following:

1. Sample layout for sleeping accommodations.
2. Storage location for drinking water and food provisions.

A104.4.3 Host building plans. Where the *storm shelter* is located within or adjacent to a *host building*, a plan of the *host building* shall be provided. The *host building* plan shall identify the following:

1. The route from the building entrance to the storm shelter entrance.
2. Primary and secondary evacuation routes from the *storm shelter* after the storm.
3. A list of major fire hazards associated with the normal use and occupancy of the premises, if applicable.

A104.4.4 Site plans. Where any portion of the storm shelter's intended occupant population is anticipated to travel from off-site to the *storm shelter*, a site plan shall be provided. The site plan shall indicate the following:

1. Site arrival points for shelter occupants.
2. Traffic pattern and parking plans.
3. Exterior routes from the parking to the building entrance.

A104.5 Registration of location. Where a storm shelter registry is maintained by the *authority having jurisdiction* or local emergency responders, the owner, owner's representative or entity responsible for operating the *storm shelter* shall register the location of the *storm shelter*. The SSPEOP shall indicate the name and contact information of the group that maintains the registry and the date that the *storm shelter* was registered, as applicable.

SECTION A105 SSPEOP PREPAREDNESS REQUIREMENTS

IS-STM A-02-23 AM

Use of this document constitutes your agreement to abide by the User Agreement located at the beginning of this document.

A105.1 General. An *approved* SSPEOP shall include preparedness requirements as **required** in **accordance with** Sections A105.2 through ~~105.6.4.4~~ **105.6.3.1**. The purpose of the plan's preparedness components is to verify that the *storm shelter* is ready and maintained for use and will be fully operational during the storm.

IS-STM A-02-23 AM

A105.2 Storm shelter management team. The SSPEOP shall include *storm shelter management team* roles and duties. At a minimum, the roles **and duties** of storm shelter manager, storm shelter assistant manager ~~and general staff~~ shall be identified. ~~The SSPEOP shall identify the primary individual currently assigned to each role and shall identify back-up staff for management roles and for general staff roles that are assigned duties considered critical to shelter emergency operations.~~

IS-STM A-02-23 AM

A105.2.1 ~~A105.2.2~~ **Duties. Management roles and duties.** The SSPEOP shall identify the **primary individual currently assigned to each** storm shelter management team ~~primary and back-up~~ role and shall identify back-up staff charged with the following critical duties:

1. Monitoring storm conditions and alerting the storm shelter management team
2. Activating the storm shelter management team
- ~~1. Authorization to issue an order to activate the *storm shelter*.~~
- ~~2. Authorization to issue an all clear for *storm shelter* deactivation.~~
3. Unlocking Opening the *storm shelter* to admit occupants, where applicable, and
4. Notifying intended storm shelter occupants of current status, such as activation of the *storm shelter* or the need to move to the *storm shelter*.
- ~~5.4. Securing and locking down all *impact-protective systems* and activating critical support systems.~~
6. Notifying occupants of an all clear to allow for occupants to leave the *storm shelter*.
7. Deactivating the *storm shelter*.

IS-STM A-02-23 AM

A105.2.1 ~~A105.2.2~~ **Contact information.** Current contact information for all identified primary and back-up shelter management team roles shall include phone numbers and email addresses. Contact information shall be updated no less than one time per year or as needed.

A105.2.3 Specialized personnel. The *storm shelter management team* shall include specialized personnel where required by Sections A105.2.3.1 through A105.2.3.3.

A105.2.3.1 Security personnel. Where the *storm shelter* is open to the general public and *storm shelter design occupant capacity* is greater than 500 or where required by the *authority having jurisdiction*, security personnel shall be designated in the SSPEOP.

A105.2.3.1.1 Duties. The duties of security personnel shall include:

1. Conduct an inspection of the *storm shelter* area and identify and address any occupant safety concerns.
2. Direct and assist the shelter occupants into the *storm shelter* at activation and for evacuation at deactivation.
3. Assist emergency response personnel where requested.

A105.2.3.2 Health care personnel. Where required by the *authority having jurisdiction*, health care personnel shall be designated in the SSPEOP to provide first aid as needed and attend to health care needs of storm shelter occupants.

A105.2.3.2.1 Duties. The duties of designated storm shelter health care personnel shall include:

1. Identify and assign medical support or first aid personnel.
2. Maintain first aid and medical support supplies for use during shelter activation.
3. Maintain confidential information provided by intended occupants who have indicated special medical needs and coordinate indicated accommodations where practicable during shelter activation.
4. Designate isolation areas for occupants who arrive with indications of communicable illnesses and provide direction to the isolation areas; provide personal protective equipment, such as masks or gloves, as appropriate.

A105.2.3.3 Fire watch personnel. Where required by the *authority having jurisdiction*, fire watch personnel shall be designated in the SSPEOP. Fire watch personnel shall remain on duty while the *storm shelter* is activated for use.

A105.2.3.3.1 Duties. On-duty fire watch personnel shall have the following responsibilities:

1. Conduct an inspection of the storm shelter area to identify and mitigate any fire hazards.
2. Keep diligent watch for fires, obstructions to *means of egress* and other hazards.
3. Take prompt measures for remediation of hazards and extinguishment of fires that occur.
4. Take prompt measures to assist in the evacuation from the *storm shelter*.

A105.2.4 Team training and team drills. Where required by the *authority having jurisdiction*, *storm shelter management team* members and their backups shall be trained periodically. The purpose of staff training is to provide members with current information on their duties and responsibilities under the SSPEOP and to provide an opportunity to practice execution of their duties with other team members through team-only or intended occupant drills.

IS-STM A-03-23 AM

A105.3 Community outreach and notification. The SSPEOP shall include the methods and procedures chosen to contact, notify and update the intended occupants of the *storm shelter*. **Notifications shall include regarding** the following information:

1. Days and hours when the *storm shelter* will be operational, including expectation of *storm shelter* use during off-hours, where applicable.
2. Activation signals **and drills**. The preferred and any alternative means of notifying the general public or intended occupants of the need to move to the *storm shelter*. The notification methods shall be distinct from other hazard warning signals. Where provided, a description of the emergency voice/alarm communication system alert tone and preprogrammed voice messages shall be included.
3. Accessing the *storm shelter*, including location of entrances and parking where applicable.
4. Policies and procedures regarding:
 - 4.1. Public health and infectious disease.

Use of this document constitutes your agreement to abide by the User Agreement located at the beginning of this document.

- 4.2. Pets.
 - 4.3. **Occupancy Storm shelter occupant regulations.**
 - 4.4. Deactivation.
5. Shelter contact information.

A105.3.1 Recordkeeping. The SSEOP shall include or reference the location of records including the dates that notifications occurred and the method of outreach implemented.

A105.4 Intended occupant drills. Where required by the *authority having jurisdiction*, intended occupant drills shall involve the movement of intended storm shelter occupants to the *storm shelter*. Unless more frequent drilling is required by the *authority having jurisdiction*, no less than one intended occupant drill shall occur yearly.

A105.4.1 Recordkeeping. The SSEOP shall include or reference the location of records on required storm shelter drills. The records shall include the following information:

1. Date and time of the drill.
2. Notification method used.
3. Identity of the person conducting the drill, staff on duty and staff participating.
4. Number of occupants relocated to the *storm shelter*.
5. Special conditions simulated.
6. Weather conditions when occupants were evacuated from the *storm shelter*.
7. Time required to accomplish complete movement of intended occupants to the *storm shelter*.
8. Problems encountered.

A105.4.2 Notification. Where required by the *authority having jurisdiction*, prior notification of shelter activation drills shall be given to the *authority having jurisdiction*.

A105.5 Communication. The SSPEOP shall identify at least one means of communication other than landline telephone or cellular telephone for the *storm shelter management team* to communicate with emergency responders or to receive critical information during or following storm shelter activation. The SSPEOP shall indicate either where the identified alternate means of communication is stored within the *storm shelter* or which designated *storm shelter management team* members are charged with bringing the device to the *storm shelter* upon activation. Appropriate alternate means of communication shall include no less than one of the following:

1. Handheld amateur radio, citizens' band radio or emergency radio capable of reaching police, fire or other emergency services.
2. A NOAA weather radio with continuously charging batteries or battery supply, as needed.
3. A commercial radio with continuously charging batteries or battery supply as needed for receiving emergency broadcasts

A105.5.1 Contact lists. The SSPEOP shall identify contact information for the following emergency services, including both emergency and non-emergency numbers and any radio frequencies:

1. Local fire department.
2. Local police department.

3. Local emergency medical services.
4. Local emergency operations center.

A105.6 Maintenance evaluations. Required maintenance evaluations shall include storm shelter facilities evaluations for all *storm shelters* and occupant capacity evaluations. The SSPEOP shall include the schedule for periodic storm shelter preparedness evaluations and identify the *storm shelter management team* roles or trained shelter maintenance staff responsible for conducting the evaluations. The purpose of storm shelter preparedness evaluations is to address storm shelter operational considerations outside the scope of Sections ~~413~~ 114.2 and ~~413~~ 114.3 of this standard.

A105.6.1 Storm shelter facilities evaluations. Storm shelter preparedness evaluations shall occur at least once a year and include the following steps:

1. Verify operation of ventilation, sanitation and lighting systems.
2. Verify operation of standby power supply.
3. Verify operation of flashlights where applicable.
4. Check fire extinguishers.
5. Check first aid supplies and resupply if required.
6. Verify operation of alternative communication devices.
7. Verify that all required signage is present and legible.
8. Verify water and food supplies where required for the storm shelter occupants.

Where storm shelter facilities evaluations indicate corrective action for storm shelter support systems, operational preparedness shall be restored by repairing or replacing the faulty systems or elements to comply with applicable requirements of this standard.

A105.6.2 Occupant capacity evaluations. *Storm shelters* shall be evaluated not less than once a year to determine if the minimum *usable floor area* per occupant as specified in Section 502 of this standard has been maintained to support the *storm shelter design occupant capacity* upon activation of the shelter. Where the storm shelter's evaluated condition has been determined to impede activation or accommodation of the *storm shelter design occupant capacity*, corrective actions shall be implemented to restore and maintain the ability to activate the *storm shelter* in accordance with Section A106 of the SSPEOP and to accommodate the *storm shelter design occupant capacity*.

A105.6.3 Recordkeeping. The SSPEOP shall include or reference the location of records on storm shelter facilities and maintenance evaluations. The records for the storm shelter maintenance evaluation shall include the following information:

1. The date and persons conducting the evaluations.
2. Findings for each identified evaluation item.
3. Subsequent corrective actions where applicable.
4. Date when corrective action completed and persons responsible.

A105.6.3.1 Impact-protective system evaluation and maintenance records. The SSPEOP shall include or provide the location of records required in Section ~~413~~ 114.4 of this standard for storm shelter maintenance and repair of walls, roofs and *impact-protective*

systems. The SSPEOP shall include or provide the location of warranties and instruction manuals for *listed* and *labeled impact-protective systems*.

SECTION A106

SSEOP EMERGENCY OPERATIONAL PROCEDURES REQUIREMENTS

A106.1 General. The SSPEOP shall take into consideration the expected warning time and the minimum design duration of the storm shelter storm type—2 hours for *tornado shelters* and 24 hours for *hurricane shelters*. The SSPEOP shall include consideration for initiating operation during and after normal operating hours of the *host building*. The SSEOP shall be updated as needed.

A106.2 Initiating storm shelter activation. The SSPEOP shall include the following information for the initiation of a storm shelter activation:

1. Identification of the designated *storm shelter management team* roles responsible for monitoring storm conditions and putting the rest of the team on alert when indicated.
2. Major tasks, including roles and responsibilities, that the designated *storm shelter management team* will perform during a tornado or hurricane watch issued by the National Weather Service.
3. Major tasks that the designated *storm shelter management team* will perform during a tornado or hurricane warning issued by the National Weather Service.
4. The SSPEOP shall identify specific triggers to initiate the following major tasks:
 - 4.1. Opening the *storm shelter*.
 - 4.2. Notifying the intended occupants of the need to move to the *storm shelter*.

A106.3 Storm shelter activation. The SSPEOP shall include the following information for activation of the storm shelter:

1. Identification of designated *storm shelter management team* roles and duties needed to evacuate intended occupants from the *host building*, campus or site arrival points to the *storm shelter* where applicable.
2. Identification of designated *storm shelter management team* roles and duties needed to assist persons unable to use the access route to the *storm shelter* unassisted.
3. Identification of each door or other impact-protective device that needs to be secured during a storm and a description of when and how to secure them. Identify the current contact information of the designated *storm shelter management team* roles and back-up role responsible for securement.

A106.4 Operations during the storm. The SSPEOP shall include the roles, responsibilities and duties of the *storm shelter management team* during the storm. Where required by the *authority having jurisdiction*, the SSPEOP shall also include the following:

1. Procedures for accounting for staff and occupants after movement to the *storm shelter* has been completed.
2. The preferred and any alternative means of reporting the active operation of the *storm shelter* to a designated emergency response organization.
3. A description of the plan for preparation, distribution and storage of water and food supplies, where provided

A106.5 Storm shelter deactivation. The SSPEOP shall include a description of how it will be determined it is safe for occupants to leave the *storm shelter*, when the *storm shelter* is occupied for an actual storm, not a drill. Where required by the *authority having jurisdiction*, the SSPEOP shall also include the following:

1. A description of special staff actions for evacuation of the *storm shelter* after the storm.
2. Procedures for accounting for staff and occupants leaving the *storm shelter* including relocation for medical assistance, relocation to recovery facilities or other plans.